

Panasonic®

Digital Super Hybrid System

User Manual

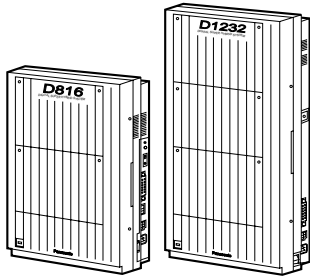

KX-TD816C
Model KX-TD1232C



Please read this manual before using Digital Super Hybrid System.

Thank you for purchasing the Panasonic Telephone System.

System Components

	Model No.	Description
Service Unit	KX-TD816 KX-TD1232	Digital Super Hybrid System (Main Unit)
Telephone	KX-T7220 KX-T7230 KX-T7235 KX-T7250 KX-T7420 KX-T7425 KX-T7431 KX-T7433 KX-T7436	Digital Proprietary Telephone Digital Proprietary Telephone with 2-line Display Digital Proprietary Telephone with 6-line Display Digital Proprietary Telephone Digital Proprietary Telephone Digital Proprietary Telephone Digital Proprietary Telephone with 1-line Display Digital Proprietary Telephone with 3-line Display Digital Proprietary Telephone with 6-line Display
Optional Equipment	KX-T7240 KX-T7440 KX-T7441	Digital DSS Console Digital DSS Console for Attendant Digital DSS Console with Answer and Release buttons
User-supplied Equipment	Single Line Telephones	

For your future reference

SERIAL NO. _____ (found on the bottom of the unit)
DATE OF PURCHASE _____
NAME OF DEALER _____
DEALER'S ADDRESS _____ _____ _____ _____
DEALER'S TEL. NO. _____

Attention

When using the KX-T7200 and KX-T7400 series, keep the following conditions in mind:

- If there is any trouble, unplug the extension line and connect a known working phone. If the known working phone operates properly, have the defective phone repaired by a specified Panasonic Factory Service Center. If the known working phone does not operate properly, check the Digital Super Hybrid System and the internal extension wiring.
- Keep the unit away from heating appliances and electrical noise generating devices such as fluorescent lamps and motors.
- The unit should be kept free of dust, moisture and vibration, and should not be exposed to direct sunlight.
- Do not use benzine, thinner, or any abrasive powder to clean the cabinet. Wipe it with a soft cloth.
- Do not use any handset other than a Panasonic handset.

WARNING

TO PREVENT FIRE OR SHOCK HAZARD, DO NOT EXPOSE THIS PRODUCT TO RAIN OR ANY TYPE OF MOISTURE.

Introduction

Who Should Use This Manual

This manual is designed for users of Digital Super Hybrid System KX-TD816 and KX-TD1232. It is to be used after the system is installed and System Programming is completed. The focus is Digital Proprietary Telephones (DPTs); KX-T7220/KX-T7230/KX-T7235/KX-T7250/KX-T7420/KX-T7425/KX-T7431/KX-T7433/KX-T7436, Digital DSS Consoles; KX-T7240/KX-T7440/KX-T7441, Single Line Telephones (SLTs) and their features. The step-by-step procedures required to activate each feature are discussed in detail. Illustrations of the KX-TD816 and the KX-TD1232 systems and the required System Programming are provided under separate cover in the Installation Manual and the Programming Guide.

Construction of This Manual

This manual consists of the following sections:

(Section 1) DPT Overview

Provides configuration information on DPTs. It provides an illustration of each telephone, identifies their feature buttons, supplies background information on these feature buttons, and provides initial settings.

(Section 2) Station Programming

Provides the steps required to assign features to DPT flexible buttons and to the DPT system.

(Section 3) User Programming

Provides the steps required to assign some features to the system.

(Section 4) Station Features and Operation (DPT/SLT)

Provides background information on the DPT/SLT features and lists the steps required to activate each feature.

(Section 5) DSS Console Features

Provides configuration information on the DSS Console. It gives background information on the DSS Console features and lists the steps required to activate each feature.

(Section 6) Appendix

Provides Display Examples, a Feature Number List, Tone List, and other information are explained in this section.

(Section 7) Index

Provides the important words and phrases to help you access the required information easily.

Features and Capabilities

KX-TD816 and KX-TD1232 systems are sophisticated and powerful systems that satisfy just what you expect of an office communications system. Some of the remarkable features are listed below.

Automatic Callback Busy (Camp-On) informs you when the selected outside line or the called party becomes idle.

Call Log, Incoming (— Option) allows you to confirm the incoming outside call information on the display. You can also call back the caller by selecting one of the memorized numbers. This feature is available only for the KX-T7230, KX-T7235, KX-T7433 and KX-T7436.

Call Log, Outgoing redials by selecting one of the last five outside calls you made, according to the number information on the display. This feature is available only for KX-T7436 and KX-T7235.

Conference, Unattended When you are in a conference with two outside parties, you can leave the conference and allow the other two parties to continue the conversation. You can also return to the conference.

Data Line Security prohibits various tones, such as call waiting tone or hold recall tone, from sounding at the extension in the data communication mode. It also blocks overriding by other extensions, such as Executive Busy Override.

Doorphone and Door Opener (— Option) enables the conversation between you and a visitor at door. You can also unlock the door a few seconds from your phone.

Executive Busy Override allows you to enter into an existing conversation at an extension/ outside line.

Full One-Touch Dialing allows you to have easy access to a desired party or system feature by pressing just one button.

Message Waiting allows you to leave a message notification for another extension. The message waiting lamp (MESSAGE indicator) gives a visual indication that a message notification has been received. Even if the Message button is not provided or assigned, a special tone after going off-hook indicates that a message notification has been received.

Paralleled Telephone Connection allows you to connect your DPT in parallel with a SLT. Each telephone can have the same extension number so that you can use either telephone. If the eXtra Device Port (XDP) feature is available through System Programming, each telephone can be connected to the same extension port but have different extension numbers so that they can act as completely different extensions.

System Feature Access Menu allows you to access various features easily by following the display on the LCD and pressing corresponding buttons. This feature is available only for the KX-T7431, KX-T7433, KX-T7436 and KX-T7235.

VPS Integration (— Option) enables forwarding any incoming call to Voice Mail. Recording or Playing back the message(s) is also available. To use Voice Mail services, installing a Voice Processing System (VPS) is required.

Terms used in the Descriptions

Feature Numbers

A feature number is an access code for various functions when programming or executing features using proprietary or single line telephones connected to the system. You can access available features by dialing the corresponding feature number (and additional number, if required).

There are two types of feature numbers as follows:

- Flexible feature number
- Fixed feature number

While fixed feature numbers cannot be changed, flexible feature numbers can be changed. Refer to the Programming Guide for details. In this manual, the default numbers are used to

describe each operation and illustration. Use the new programmed number if you have changed a flexible feature number. The lists of fixed numbers and default flexible feature numbers are shown in the Appendix.

If you use a dial pulse (DP) type single line telephone (SLT);

It is not possible to access features that have "*" or "#" in their feature numbers.

Tones

Various tone types, such as Confirmation tone, Dial tone, Call Waiting tone, etc. are explained in the Appendix.

Display

The display examples are in each operation step, if required. The display information list is in the Appendix for your convenience.

Programming Guide References

The related and required programming titles are noted for your reference in the Programming Guide. System Programming should be done by the extension which connected to Jack number 01 or the System Manager. A KX-T7431, KX-T7433, KX-T7436, KX-T7230 and KX-T7235 can be used for this programming. Station Programming is individual programming at your own proprietary telephone (PT). You can customize the extension to your needs using any type of proprietary telephone.

Features Guide References

The related feature titles are noted for your reference in the Features Guide.

User Manual References

The related feature titles are noted for your reference in this manual.

Warning

Warning to the customer regarding the system password.

- a) Please maintain the secrecy of the password. Because a person who knows the password can easily take over the control of any PBX system in the market and he may proceed to commit toll fraud.
- b) Please select the dealer whom you can trust for the installation and maintenance.
- c) Please change the password periodically.
- d) We strongly recommend that you set the system password to 7 digits for maximum protection against "hackers".

Information

This Class A digital apparatus complies with Canadian ICES-003.

Notice:

The Industry Canada label identifies certified equipment. This certification means that the equipment meets telecommunications network protective, operational and safety requirements as prescribed in the appropriate Terminal Equipment Technical Requirements document(s). The Department does not guarantee the equipment will operate to the user's satisfaction.

Before installing this equipment, users should ensure that it is permissible to be connected to the facilities of the local telecommunications company. The equipment must also be installed using an acceptable method of connection. The customer should be aware that compliance with the above conditions may not prevent degradation of service in some situations.

Repairs to certified equipment should be coordinated by a representative designated by the supplier. Any repairs or alterations made by the user to this equipment, or equipment malfunctions, may give the telecommunications company cause to request the user to disconnect the equipment.

Users should ensure for their own protection that the electrical ground connections of the power utility, telephone lines and internal metallic water pipe system, if present, are connected together. This precaution may be particularly important in rural areas.

Caution:

Users should not attempt to make such connections themselves, but should contact the appropriate electric inspection authority, or electrician, as appropriate.

Notice:

The Ringer Equivalence Number (REN) assigned to each terminal device provides an indication of the maximum number of terminals allowed to be connected to a telephone interface. The termination on an interface may consist of any combination of devices subject only to the requirement that the sum of the Ringer Equivalence Numbers of all the devices does not exceed 5.

The Ringer Equivalence Number of This Unit:
(found on the bottom of the unit)

Renseignements

Cet appareil numérique de la classe A est conforme à la norme NMB-003 du Canada.

AVIS:

L'étiquette d'Industrie Canada identifie le matériel homologué. Cette étiquette certifie que le matériel est conforme aux normes de protection, d'exploitation et de sécurité des réseaux de télécommunications, comme le prescrivent les documents concernant les exigences techniques relatives au matériel terminal. Le Ministère toutefois n'assure pas que le matériel fonctionnera à la satisfaction de l'utilisateur.

Avant d'installer ce matériel, l'utilisateur doit s'assurer qu'il est permis de le raccorder aux installations de l'entreprise locale de télécommunications. Le matériel doit également être installé en suivant une méthode acceptée de raccordement. L'abonné ne doit pas oublier qu'il est possible que la conformité aux conditions énoncées ci-dessus n'empêchent pas la dégradation du service dans certaines situations.

Les réparations de matériel homologué doivent être coordonnées par un représentant désigné par le fournisseur. L'entreprise de télécommunications peut demander à l'utilisateur de débrancher un appareil à la suite de réparations ou de modifications effectuées par l'utilisateur ou à cause de mauvais fonctionnement.

Pour sa propre protection, l'utilisateur doit s'assurer que tous les fils de mise à la terre de la source d'énergie électrique, des lignes téléphoniques et des canalisations d'eau métalliques, s'il y en a, sont raccordés ensemble. Cette précaution est particulièrement importante dans les régions rurales.

Avertissement:

L'utilisateur ne doit pas tenter de faire ces raccordements lui-même; il doit avoir recours à un service d'inspection des installations électriques, ou à un électricien, selon le cas.

AVIS:

L'indice d'équivalence de la sonnerie (IES) assigné à chaque dispositif terminal indique le nombre maximal de terminaux qui peuvent être raccordés à une interface. La terminaison d'une interface téléphonique peut consister en une combinaison de quelques dispositifs, à la seule condition que la somme d'indices d'équivalence de la sonnerie de tous les dispositifs n'excède pas 5.

L'indice d'équivalence de la sonnerie de cet appareil est:
(inscrit sur le dessous de l'appareil)

Table of Contents

1	DPT Overview	
1.1	Configuration	16
1.1.1	Configuration	16
1.1.2	Location of Controls	17
1.1.3	Connection	26
1.1.4	Feature Buttons	28
1.1.5	Initial Setting for KX-T7400 Series	34
1.1.6	Initial Setting for KX-T7200 Series	39
1.1.7	LED Indication	43
2	Station Programming	
2.1	Station Programming Instructions	46
2.1.1	Station Programming Instructions	46
2.2	Station Programming	52
2.2.1	Initial Settings	52
2.2.2	Flexible Button Assignment	54
2.2.3	Phantom Extension Ringing On/Off Set	56
2.2.4	Ringing Tone Selection for CO Buttons	57
2.2.5	Ringing Tone Selection for Intercom Calls	58
2.2.6	Self-Extension Number Confirmation	59
2.2.7	Station Programming Data Default Set	60
2.2.8	Station Speed Dialing Number/Name Assignment [KX-T7235/KX-T7431/KX-T7433/ KX-T7436 only]	61
3	User Programming	
3.1	User Programming Instructions	70
3.1.1	General Programming Instructions	70
3.1.2	Programming Methods	74
3.2	User Programming	76
3.2.1	[000] Date and Time Set	76
3.2.2	[001] System Speed Dialing Number Set	79
3.2.3	[002] System Speed Dialing Name Set	82
3.2.4	[003] Extension Number Set	85
3.2.5	[004] Extension Name Set	88
3.2.6	[017] DISA User Codes	91
4	Station Features and Operation (DPT/SLT)	
4.1	Before Operating	94
4.1.1	Before Operating	94
4.2	Basic Operations	97
4.2.1	Making Calls	97
4.2.2	Receiving Calls	99
4.3	Station Features and Operation	100
4.3.1	Absent Message Capability	100
4.3.2	Account Code Entry	103
4.3.3	Alternate Calling — Ring / Voice	107

4.3.4	Answering, Direct Outside Line [PT only]	109
4.3.5	Automatic Callback Busy (Camp-On)	110
4.3.6	Background Music (BGM) [PT only]	113
4.3.7	Busy Station Signaling (BSS)	114
4.3.8	Call Forwarding — SUMMARY	116
4.3.9	Call Forwarding — All Calls	118
4.3.10	Call Forwarding — Busy	119
4.3.11	Call Forwarding — No Answer	120
4.3.12	Call Forwarding — Busy / No Answer	122
4.3.13	Call Forwarding — to Outside Line	124
4.3.14	Call Forwarding — Follow Me	126
4.3.15	Call Forwarding — CANCEL	128
4.3.16	Call Hold	130
4.3.17	Call Hold, Exclusive [PT only]	132
4.3.18	Call Hold Retrieve	134
4.3.19	Call Park	136
4.3.20	Call Pickup, Directed	138
4.3.21	Call Pickup, Group	139
4.3.22	Call Pickup, Outside Line	140
4.3.23	Call Pickup Deny	141
4.3.24	Call Splitting	142
4.3.25	Call Transfer — to Extension	144
4.3.26	Call Transfer — to Outside Line	147
4.3.27	Call Waiting	149
4.3.28	Call Waiting from Central Office	152
4.3.29	Camp-On Transfer to Phantom Extension	154
4.3.30	Conference	156
4.3.31	Conference, Unattended [PT only]	160
4.3.32	CTI (Computer Telephony Integration) Code Entry	162
4.3.33	Data Line Security	163
4.3.34	Direct Inward System Access (DISA)	165
4.3.35	Do Not Disturb (DND)	169
4.3.36	Do Not Disturb (DND) Override	172
4.3.37	Doorphone Call	174
4.3.38	Electronic Station Lockout	177
4.3.39	Emergency Call	179
4.3.40	Executive Busy Override — Extension	180
4.3.41	Executive Busy Override — Outside Line [PT only]	182
4.3.42	Executive Busy Override Deny	184
4.3.43	External Feature Access	185
4.3.44	Flash [PT only]	187
4.3.45	Full One-Touch Dialing [PT only]	188
4.3.46	Handset Microphone Mute [PT only]	189
4.3.47	Hands-free Answerback [PT only]	190
4.3.48	Hands-free Operation [PT only]	191
4.3.49	Intercom Calling	193
4.3.50	Live Call Screening (LCS) [PT only]	195
4.3.51	Lockout	202
4.3.52	Log-In / Log-Out	203

4.3.53	Message Waiting.....	205
4.3.54	Microphone Mute [PT only].....	209
4.3.55	Night / Day (Lunch / Break) Service.....	210
4.3.56	Off-Hook Call Announcement (OHCA)	215
4.3.57	Off-Hook Call Announcement (OHCA) —Whisper [PT only]	219
4.3.58	Off-Hook Monitor [PT only].....	223
4.3.59	One-Touch Dialing [PT only].....	225
4.3.60	Operator Call	226
4.3.61	Outward Dialing, Line Access — SUMMARY	227
4.3.62	Paging — SUMMARY.....	230
4.3.63	Paging — ANSWER	234
4.3.64	Paging — Deny [PT only]	235
4.3.65	Paging and Transfer.....	236
4.3.66	Paralleled Telephone Connection	240
4.3.67	Phantom Extension.....	242
4.3.68	Pickup Dialing (Hot Line).....	246
4.3.69	Privacy Release [PT only]	248
4.3.70	Pulse to Tone Conversion	250
4.3.71	Quick Dialing	251
4.3.72	Redial, Last Number.....	252
4.3.73	Redial, Saved Number [PT only].....	253
4.3.74	Secret Dialing [PT only].....	254
4.3.75	Station Program Clear	255
4.3.76	Station Speed Dialing	257
4.3.77	System Speed Dialing.....	259
4.3.78	Timed Reminder	261
4.3.79	Toll Restriction Override — SUMMARY	264
4.3.80	Toll Restriction Override by Account Code Entry	265
4.3.81	Toll Restriction Override for System Speed Dialing.....	266
4.3.82	Trunk Answer From Any Station (TAFAS).....	267
4.3.83	Two-Way Recording into Voice Mail [PT only].....	268
4.3.84	Uniform Call Distribution (UCD)	270
4.3.85	Voice Mail Integration	271
4.3.86	Voice Mail Transfer [PT only].....	274
4.3.87	Walking COS.....	276
4.4	Operator / Manager Service Features	278
4.4.1	Operator/Manager Service Features	278
4.4.2	Background Music (BGM) — External	279
4.4.3	Call Log Lock Control, Incoming	282
4.4.4	Hotel Application — Room Status (operator only).....	283
4.4.5	Live Call Screening Password Control.....	286
4.4.6	Outgoing Message (OGM).....	287
4.4.7	Remote Station Lock Control.....	296
4.4.8	System Working Report.....	297
4.4.9	Timed Reminder, Remote (Wake-Up Call)	300
4.5	Special Display Features	308
4.5.1	Special Display Features	308
4.5.2	Call Forwarding / Do Not Disturb (KX-T7436 / KX-T7235 only).....	309
4.5.3	Call Log, Incoming (KX-T7436 / KX-T7433 / KX-T7235 / KX-T7230 only)	311

4.5.4	Call Log Lock, Incoming (KX-T7436 / KX-T7433 / KX-T7235 / KX-T7230 only) ..	317
4.5.5	Call Log, Outgoing (KX-T7436 / KX-T7235 only).....	319
4.5.6	Call Monitoring in Station Hunting (KX-T7436 / KX-T7235 only)	320
4.5.7	KX-T7235 Display Features	322
4.5.8	KX-T7235 Display Features - Call Directory	324
4.5.9	KX-T7235 Display Features - System Feature Access Menu.....	325
4.5.10	KX-T7431 / KX-T7433 / KX-T7436 Display Features	334
4.5.11	KX-T7431 / KX-T7433 / KX-T7436 Display Features - Call Directory	337
4.5.12	KX-T7431 / KX-T7433 / KX-T7436 Display Features - System Feature Access Menu ..	342
5	DSS Console Features	
5.1	Configuration.....	348
5.1.1	Configuration.....	348
5.1.2	Location of Controls.....	349
5.1.3	Feature Buttons	351
5.2	Station Programming.....	352
5.2.1	Station Programming Instructions.....	352
5.2.2	Extension Number Assignment.....	354
5.2.3	One-Touch Dialing Assignment.....	355
5.2.4	One-Touch Access Assignment for System Features.....	356
5.3	DSS Console Features	357
5.3.1	Direct Station Dialing.....	357
5.3.2	One-Touch Dialing	358
5.3.3	One-Touch Access for System Features.....	359
5.3.4	Call Transfer.....	360
5.3.5	ANSWER and RELEASE Buttons Operation [KX-T7441 only]	361
6	APPENDIX	
6.1	APPENDIX	364
6.1.1	Display Examples.....	364
6.1.2	Feature Number List.....	371
6.1.3	Tone List.....	375
6.1.4	Troubleshooting.....	377
7	Index.....	379

Section 1

DPT Overview

Note: All illustrations used in the initial setting are based on model KX-T7235.

1.1 Configuration

1.1.1 Configuration

Panasonic Digital Proprietary Telephones (DPTs) are available to utilize various features of the KX-TD816 and KX-TD1232 System, in addition to supporting basic telephone services (making and receiving calls).

There are nine DPT models.

KX-T7400 Series

	KX-T7420	KX-T7425	KX-T7431	KX-T7433	KX-T7436
Display	None	None	16 char./line, 1-line LCD	Tilt-up, 16 char./line, 3-line LCD	Tilt-up, 24 char./line, 6-line LCD
Soft Buttons and Function Buttons	None	None	None	3 Soft Buttons	3 Soft Buttons/ 10 Function Buttons
Jog Dial	Yes	Yes	Yes	Yes	Yes
CO Buttons	12	24	12	24	24
Fixed Feature Buttons	Refer to the "Fixed Buttons" in 1.1.4 Feature Buttons				

KX-T7200 Series

	KX-T7220	KX-T7230	KX-T7235	KX-T7250
Display	None	16 char./line, 2-line LCD	Tilt-up, 24 char./line, 6-line LCD	None
Soft Buttons and Function Buttons	None	3 Soft Buttons	3 Soft Buttons/ 10 Function Buttons	None
Speakerphone	Yes	Yes	Yes	Monitor only
CO Buttons	24	24	12	6
Fixed Feature Buttons	Refer to the "Fixed Buttons" in 1.1.4 Feature Buttons			

1.1.2 Location of Controls

KX-T7420

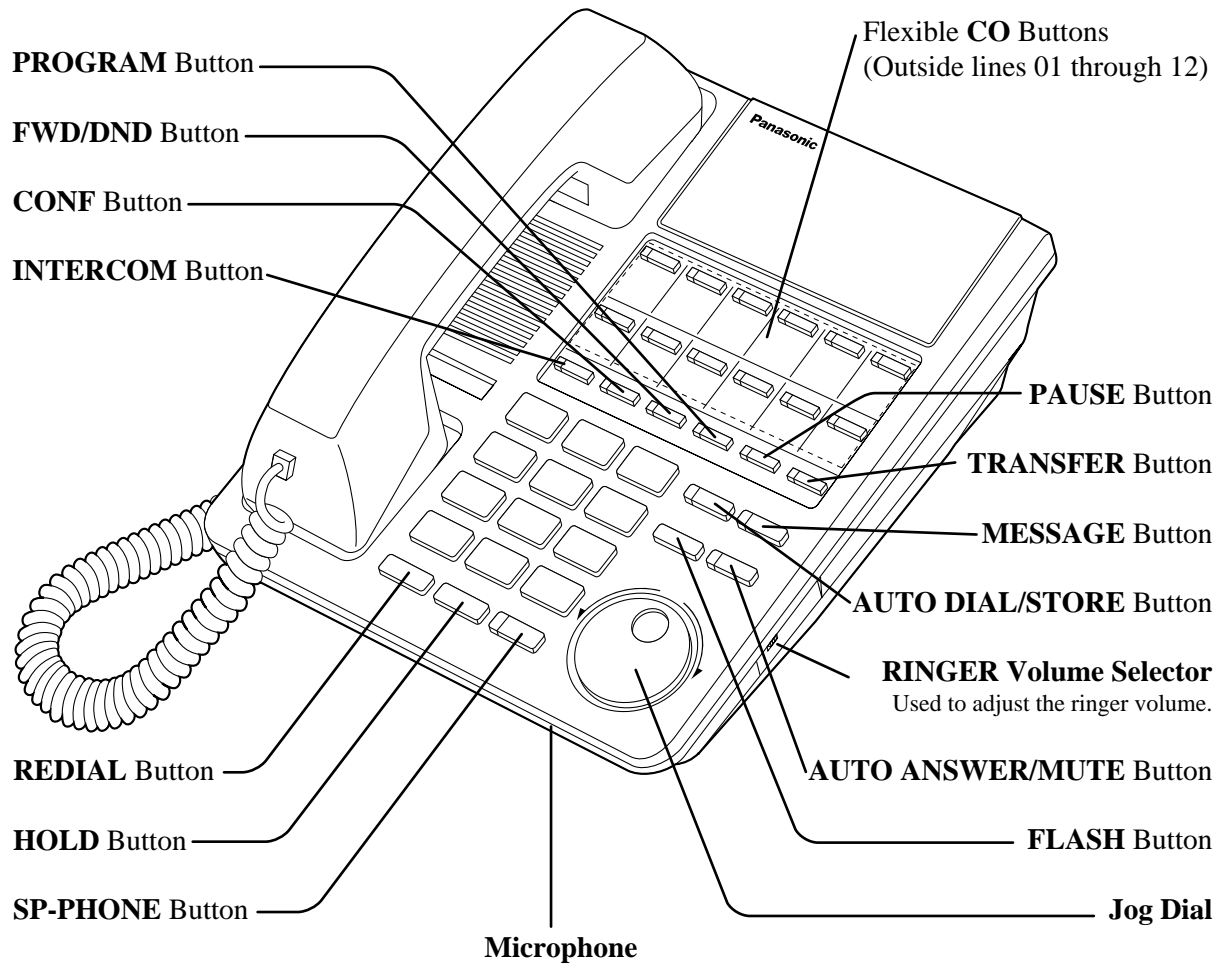

KX-T7425

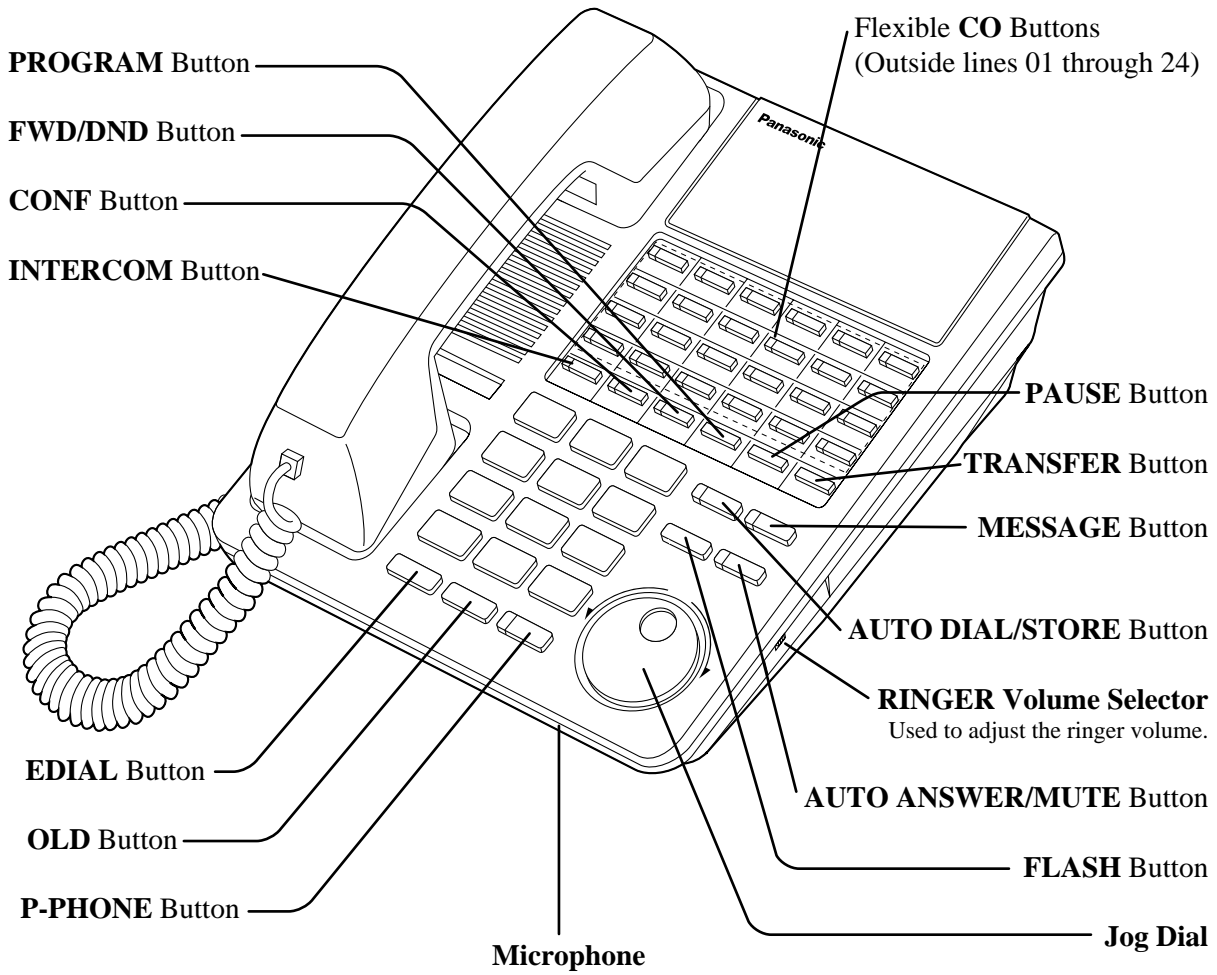

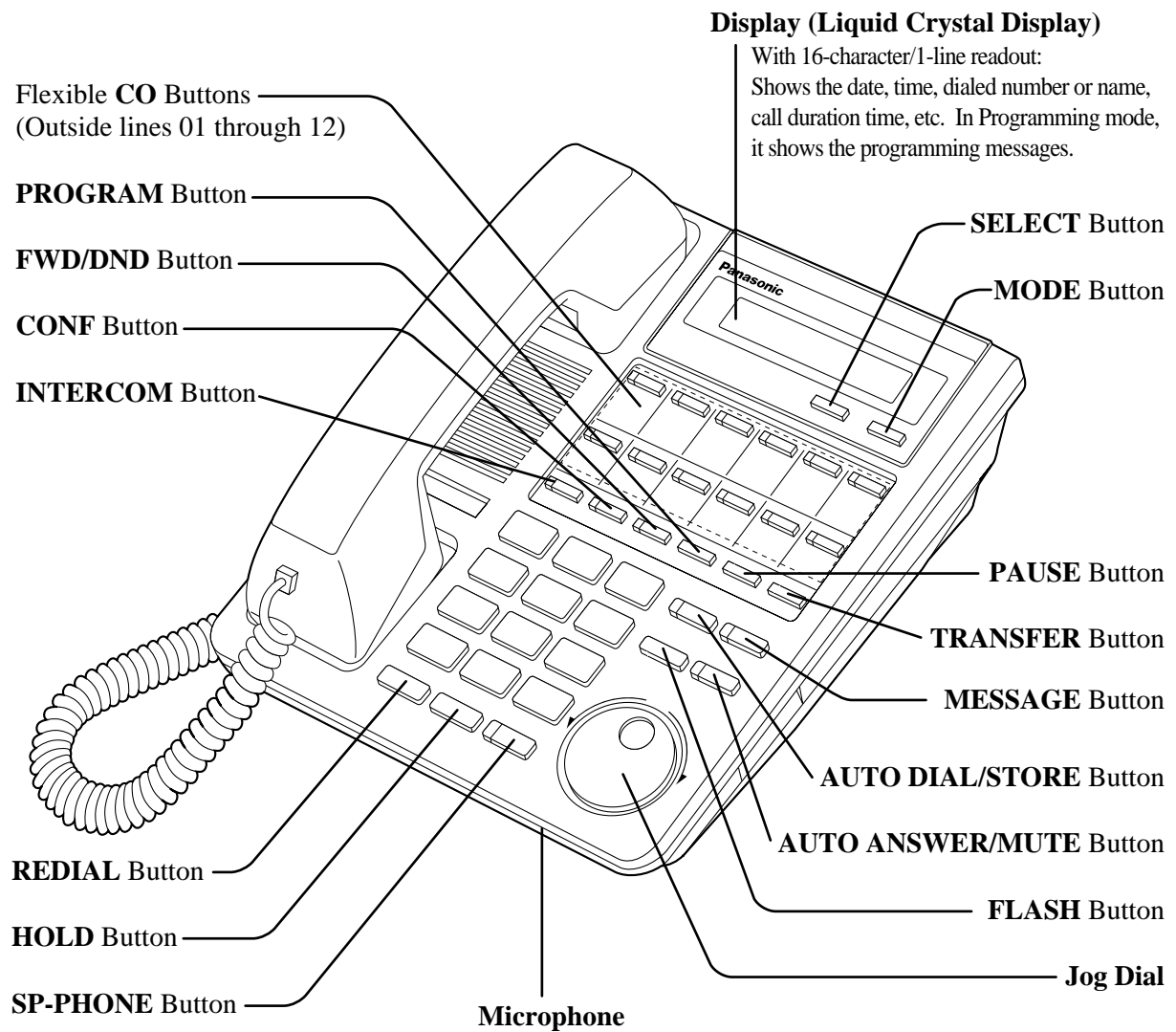
KX-T7431

KX-T7433

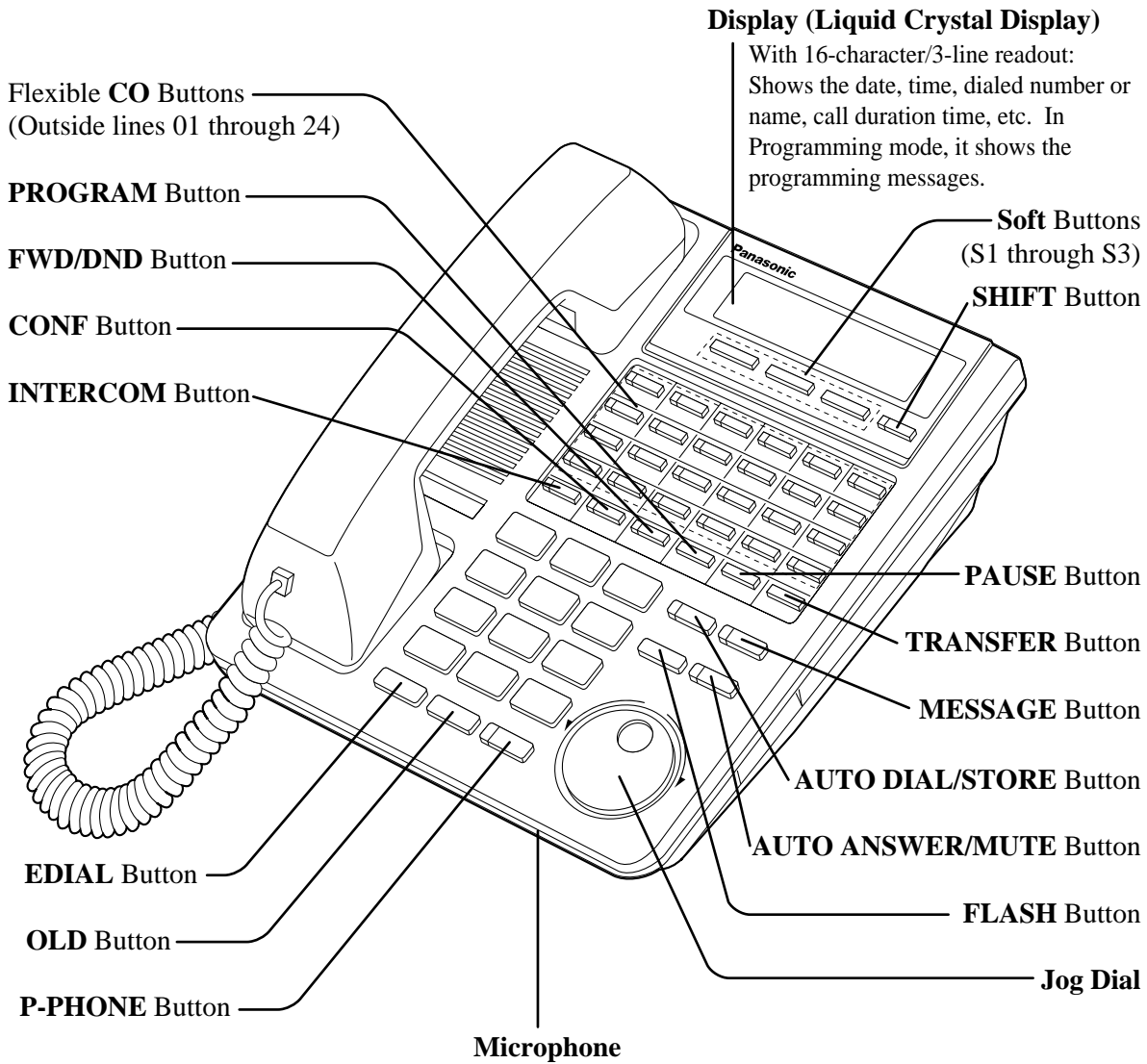

To lift or set down the display:

- To lift the display

- 1 Press the LCD ADJ button.
- 2 Lift up the display.

- To set down the display

- 1 Press the LCD ADJ button.
- 2 Press down the display.

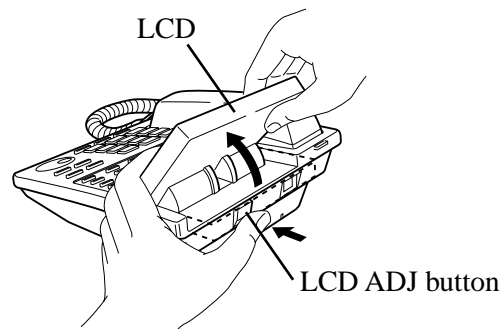

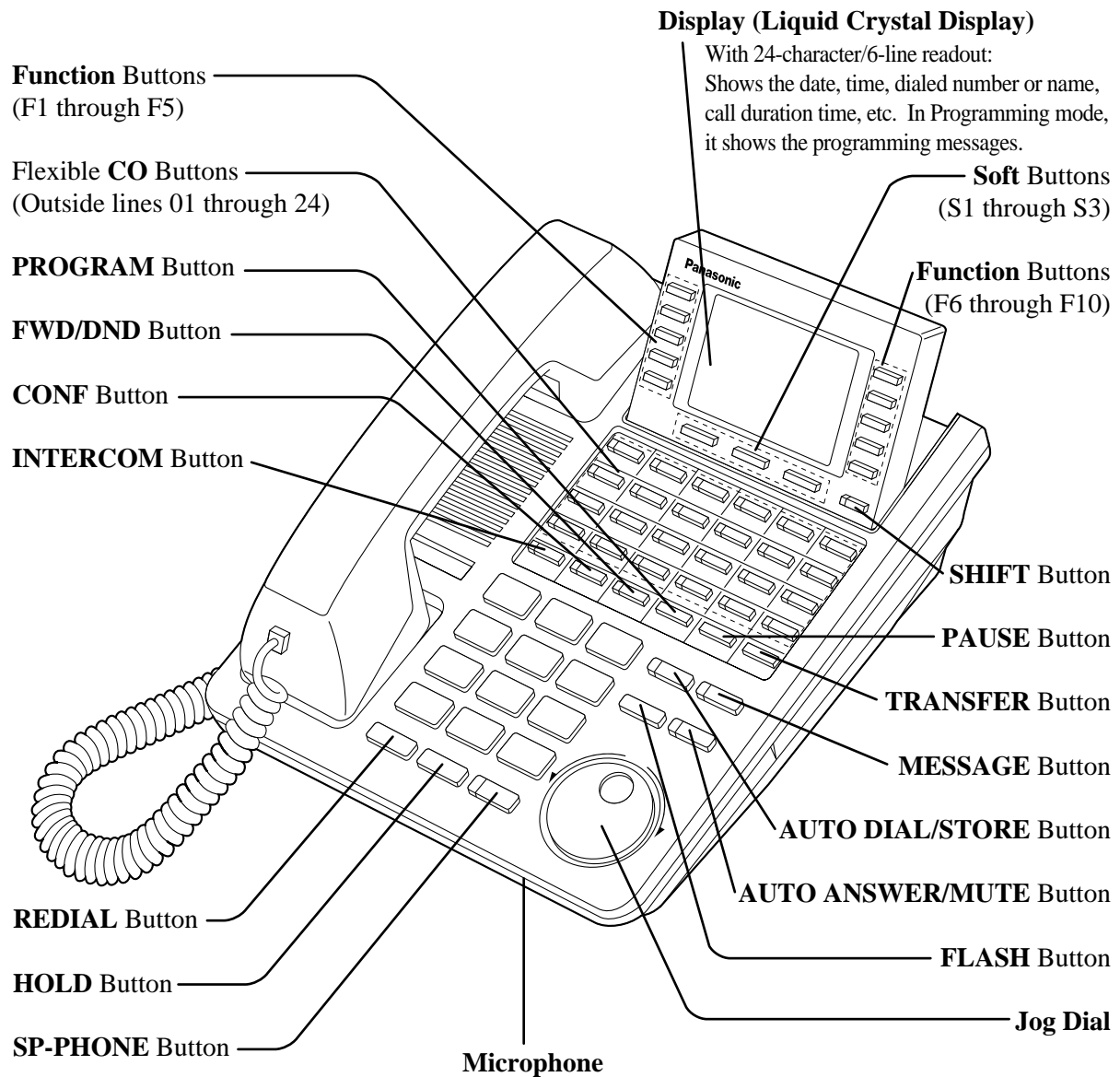
KX-T7436**To lift or set down the display:**

- **To lift the display**
 - 1 Press the LCD ADJ button.
 - 2 Lift up the display.
- **To set down the display**
 - 1 Press the LCD ADJ button.
 - 2 Press down the display.

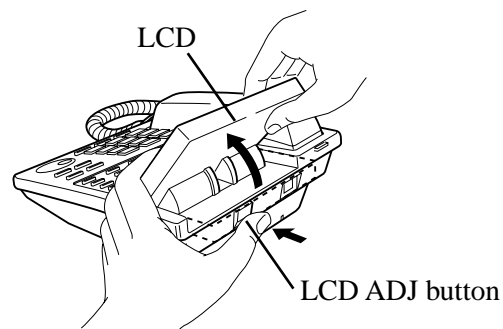

KX-T7220

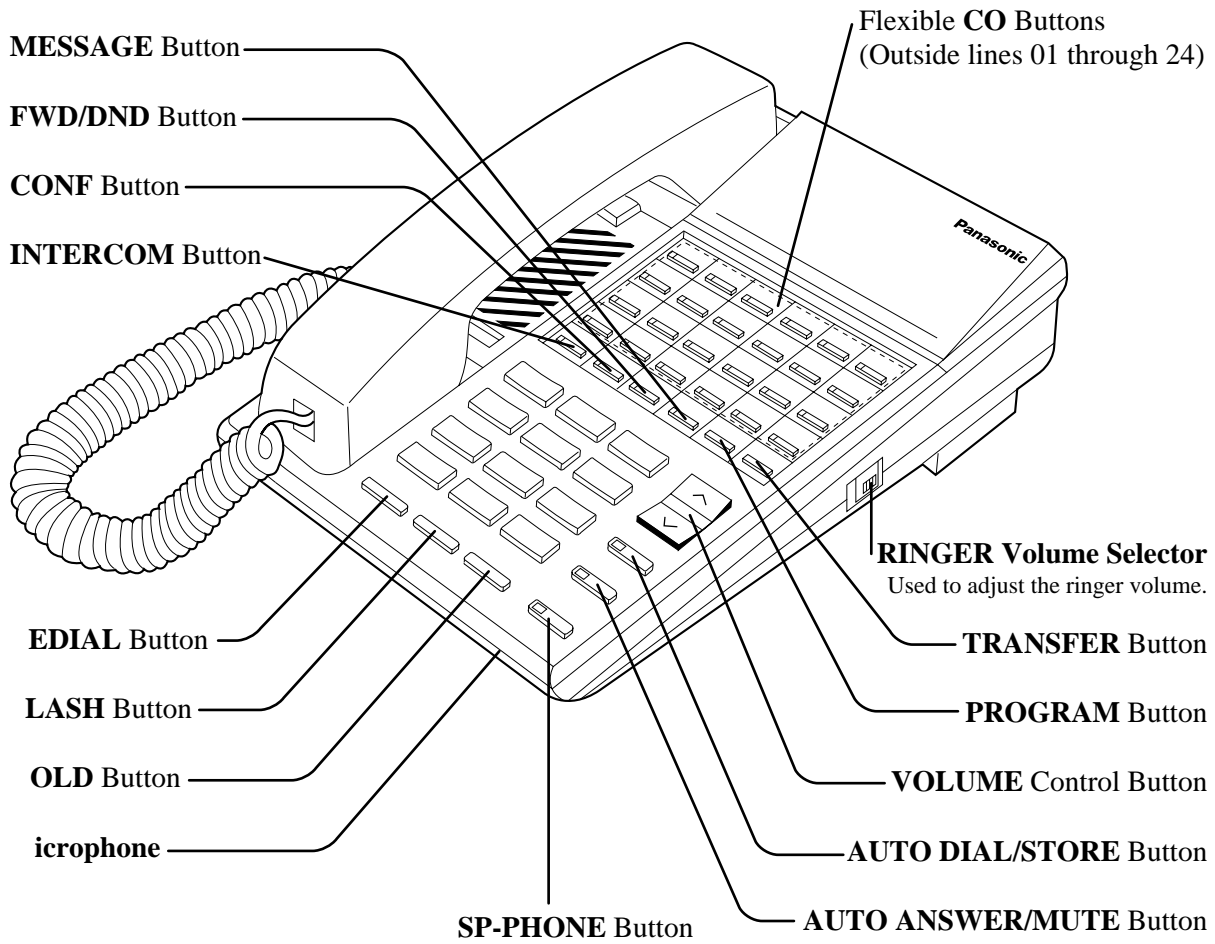

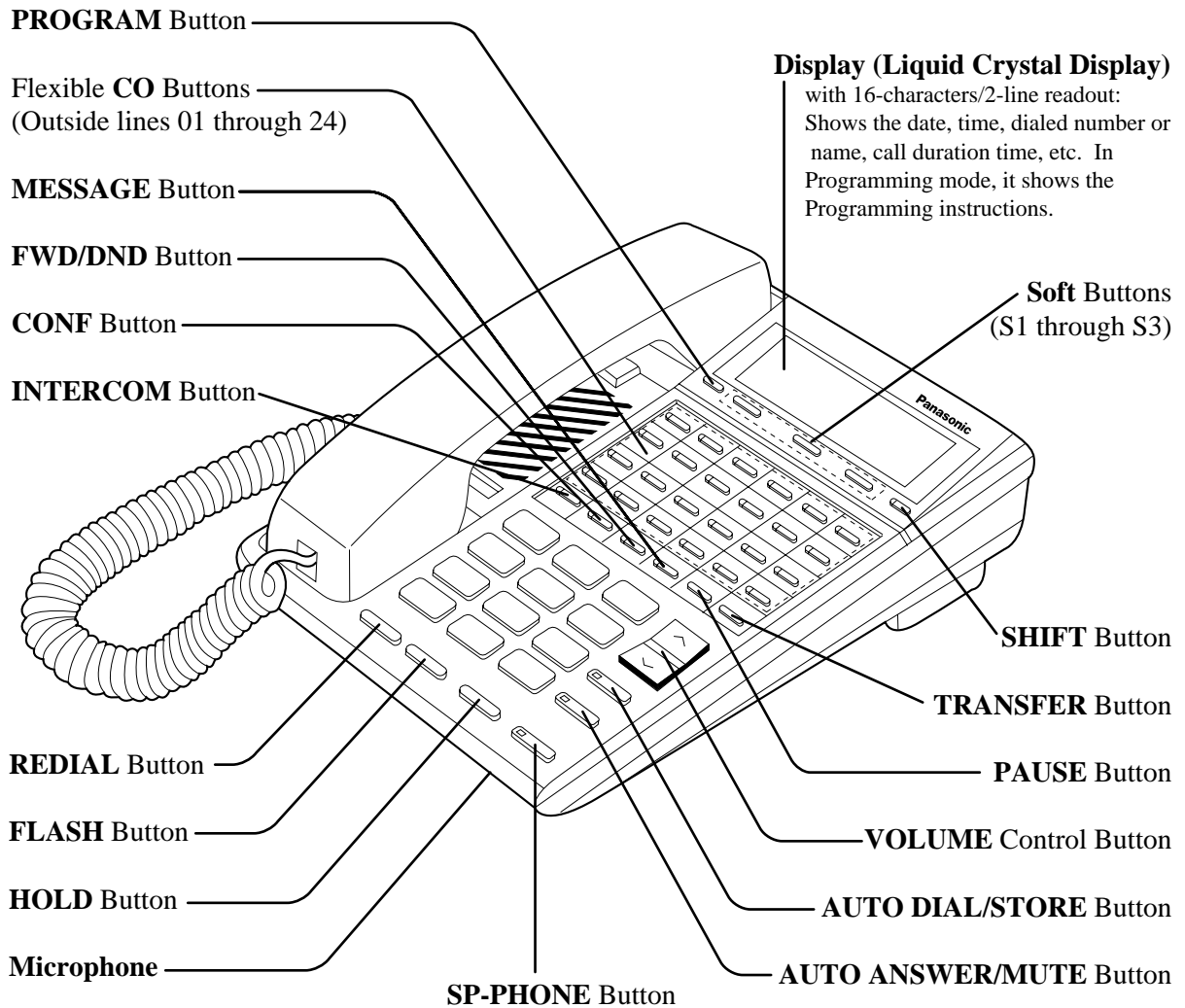
KX-T7230

KX-T7235

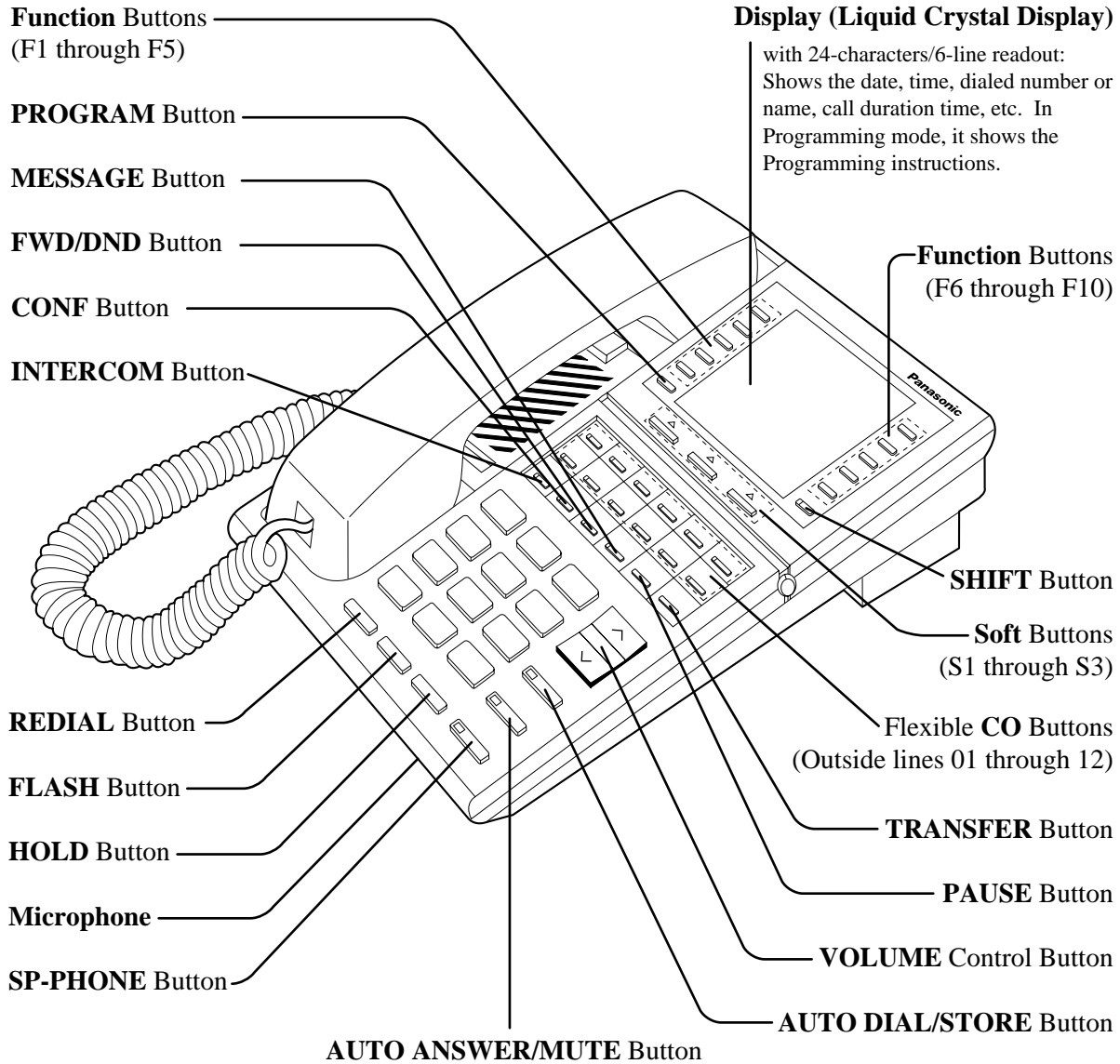

Display (Liquid Crystal Display)

with 24-characters/6-line readout:
Shows the date, time, dialed number or name, call duration time, etc. In Programming mode, it shows the Programming instructions.

To lift or set down the display:

- **To lift the display**
 - 1 Press the LCD ADJ button.
 - 2 Lift up the display.
- **To set down the display**
 - 1 Press the LCD ADJ button.
 - 2 Press down the display.

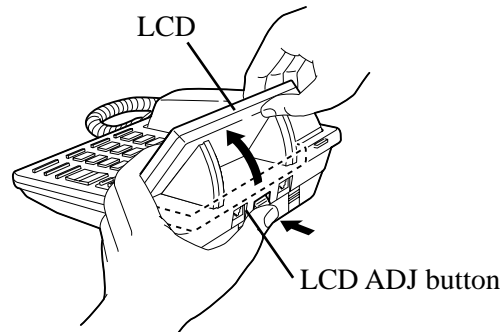

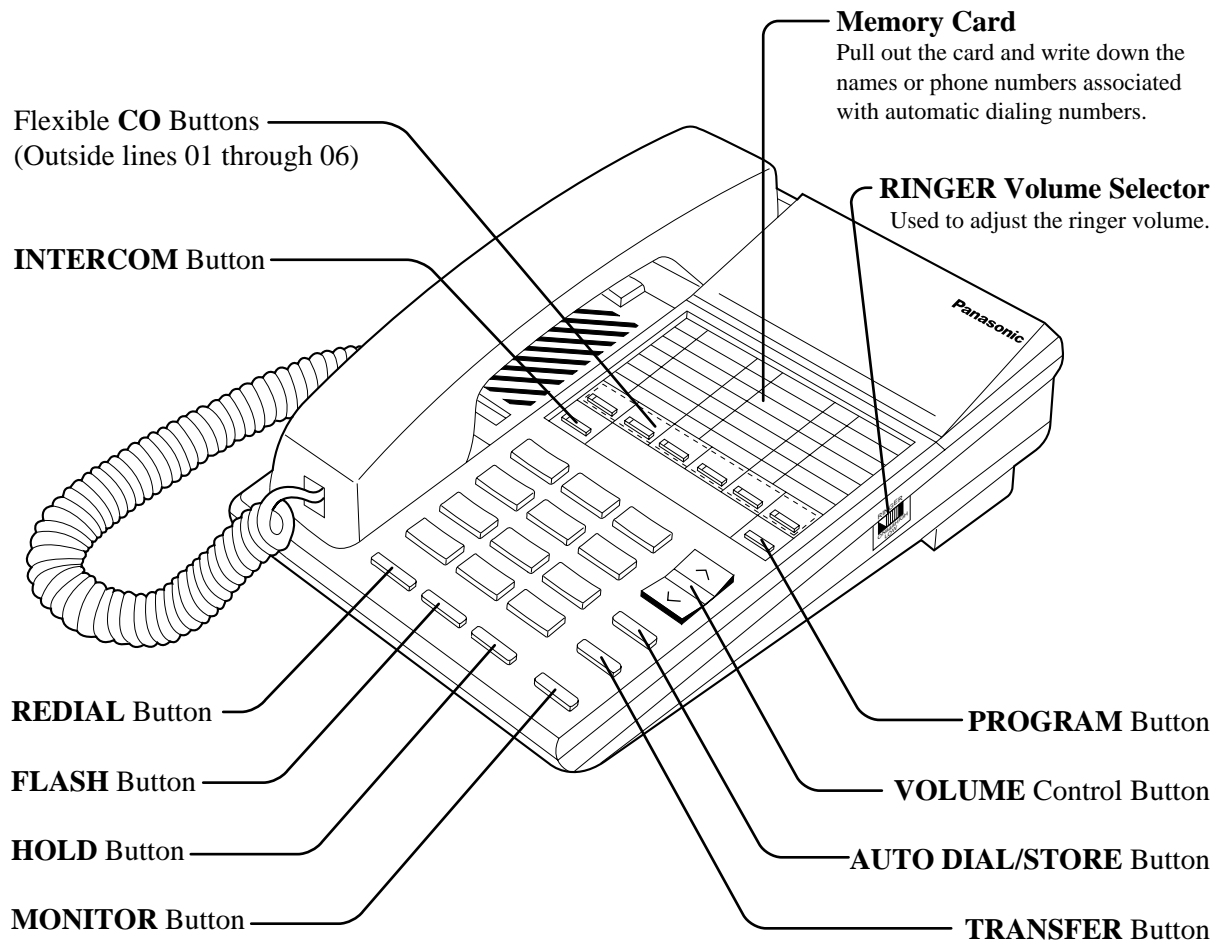
KX-T7250

1.1.3 Connection

Connect as shown.

KX-T7400 Series DPTs

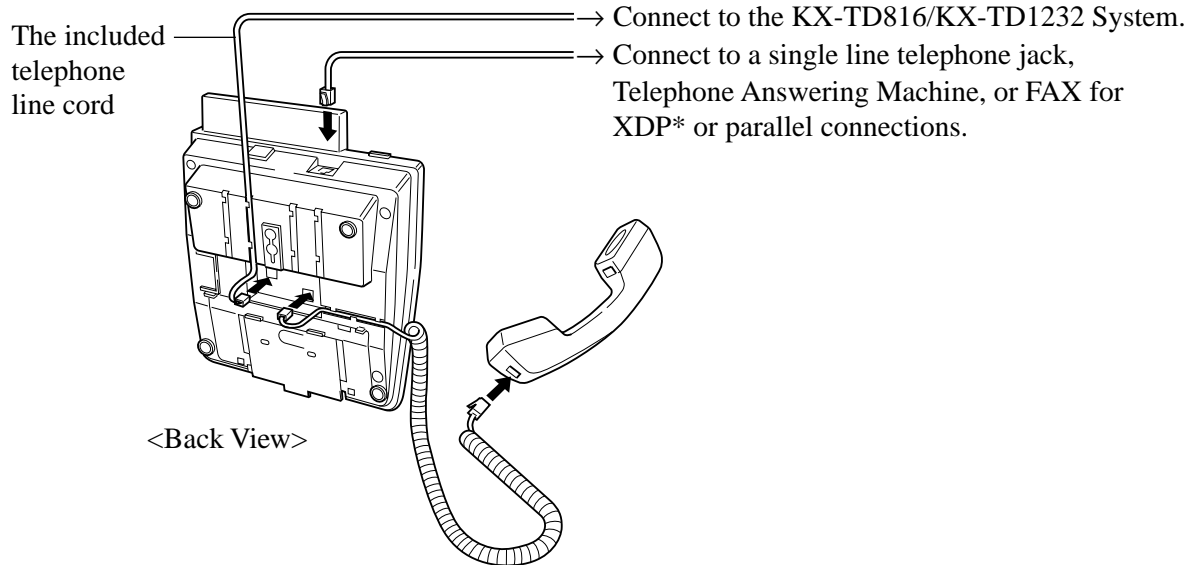

* XDP(eXtra Device Port) expands the number of telephones available in the system by allowing an extension port to contain two telephones. For more details, please consult with your dealer.

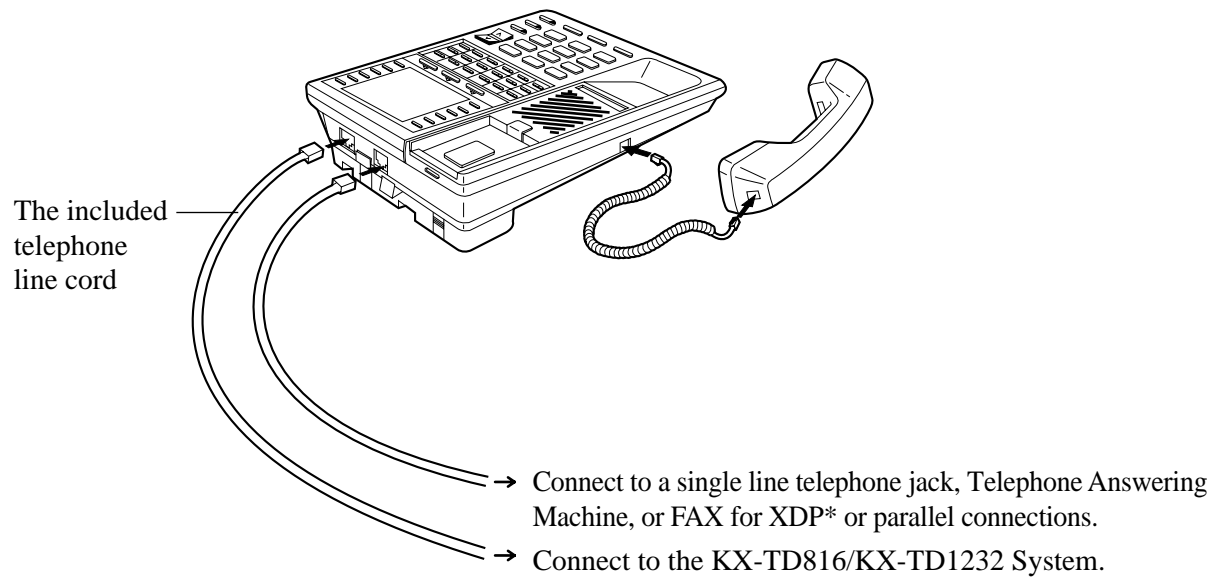
KX-T7200 Series DPTs

** XDP (eXtra Device Port) expands the number of telephones available in the system by allowing an extension port to contain two telephones. For more details, please consult with your dealer.*

1.1.4 Feature Buttons

Digital proprietary telephones (DPTs) have the following types of Feature Buttons:

- Fixed Buttons
- Flexible Buttons

Fixed Buttons

Fixed buttons have specific functions permanently assigned to them. These default function assignments cannot be changed. The following table lists the fixed buttons located on each DPT model.

Feature Button	T7420	T7425	T7431	T7433	T7436	T7220	T7230	T7235	T7250
AUTO ANSWER/MUTE	✓	✓	✓	✓	✓	✓	✓	✓	
AUTO DIAL/STORE	✓	✓	✓	✓	✓	✓	✓	✓	✓
CONF	✓	✓	✓	✓	✓	✓	✓	✓	
FLASH	✓	✓	✓	✓	✓	✓	✓	✓	✓
Function buttons					✓			✓	
FWD/DND	✓	✓	✓	✓	✓	✓	✓	✓	
HOLD	✓	✓	✓	✓	✓	✓	✓	✓	✓
INTERCOM	✓	✓	✓	✓	✓	✓	✓	✓	✓
Jog Dial	✓	✓	✓	✓	✓				
MESSAGE	✓	✓	✓	✓	✓	✓	✓	✓	
MODE			✓						
MONITOR									✓
PAUSE	✓	✓	✓	✓	✓		✓	✓	
PROGRAM	✓	✓	✓	✓	✓	✓	✓	✓	✓
REDIAL	✓	✓	✓	✓	✓	✓	✓	✓	✓
SELECT			✓						
SHIFT				✓	✓		✓	✓	
Soft buttons				✓	✓		✓	✓	
SP-PHONE	✓	✓	✓	✓	✓	✓	✓	✓	

Feature Button	T7420	T7425	T7431	T7433	T7436	T7220	T7230	T7235	T7250
TRANSFER	✓	✓	✓	✓	✓	✓	✓	✓	✓
VOLUME						✓	✓	✓	✓

" ✓ " indicates the button is available.

Usage

AUTO ANSWER/MUTE Button

Used for Hands-free answer back; or it turns the microphone off during a conversation.

AUTO DIAL/STORE Button

Used for System Speed Dialing or storing program changes.

CONF (Conference) Button

Used to establish a three-party conference.

FLASH Button

Sends an External Feature Access signal to the central office or host PBX to access their system features. If a PBX is not being used, this button can be used to disconnect the current call and start another call without hanging up.

Function (F1 through F10) Buttons

Used to perform the corresponding displayed function or operation.

FWD/DND (Call Forwarding/Do Not Disturb) Button

Used to program the Call Forwarding feature or set the Do Not Disturb (DND) feature.

HOLD Button

Used to place a call on hold.

INTERCOM Button

Used to make or receive extension calls.

Jog Dial

Used to adjust the volume of the handset receiver, headset, ringer and speaker. It also adjusts the display contrast. Refer to "Initial Setting for KX-T7400 Series" in this section. For KX-T7431, KX-T7433 and KX-T7436 users, it is also used to select data from the Call Directory and the System Feature Access Menu.

MESSAGE Button

Used to leave a notification to a busy extension or call back the message notification sender.

MODE Button

Used to shift the display in order to access various features.

MONITOR Button

Used for a hands-free dialing operation.

PAUSE Button

Inserts a pause in speed dial numbers or in One-Touch dial numbers.

PROGRAM Button

Used to enter and exit the Programming mode.

With the KX-T7220 and KX-T7250, it can also be used as the PAUSE button.

REDIAL Button

Used for the Last Number Redial.

SELECT Button

Used to select the displayed function or to call the displayed phone number.

SHIFT Button

Used to access the second and third level of Soft Button functions.

Soft (S1 through S3) Buttons

Used to perform the function or operation that appears on the bottom line of the display.

SP-PHONE (Speakerphone) Button

Used for a hands-free speakerphone operation.

TRANSFER Button

Transfers a call to another extension or external destination.

VOLUME Control Button

Used to adjust the volume of the handset receiver, headset, ringer and speaker; it also adjusts the display contrast. Refer to 1.1.6 Initial Setting for KX-T7200 Series.

Flexible Buttons

Flexible Buttons do not have specific features permanently assigned to them. Features are assigned to Flexible Buttons through System or Station Programming. "Flexible Button Assignment" is addressed in "Station Programming". The three types of Flexible Buttons are as follows:

- **Flexible CO buttons** (located on PT only)
- **Flexible DSS buttons** (located on DSS Console only)
- **Programmable Feature (PF) buttons** (located on DSS Console, KX-T7240, only)

The following table outlines the features that can be assigned to the Flexible Buttons:

Button	CO	DSS	PF
Features to be assigned			
Single-CO	✓		
Group-CO	✓		
Loop-CO	✓		
DSS (Direct Station Selection)	✓	✓	
Phantom Extension	✓	✓	
ONE-TOUCH (One-Touch Dialing)	✓	✓	✓
MESSAGE (Message Waiting)	✓	✓	
MESSAGE (Another/Phantom Extension)	✓	✓	
FWD/DND (Call Forwarding/Do Not Disturb)	✓	✓	✓
SAVE (Saved Number Redial)	✓	✓	✓
ACCOUNT (Account Code Entry)	✓	✓	✓
CONF (Conference)	✓	✓	✓
Voice Mail (VM) Transfer	✓	✓	✓
Log-In / Log-Out	✓		
Two-Way Record*	✓	✓	
Two-Way Transfer*	✓	✓	
LCS (Live Call Screening)*	✓	✓	
LCS (Live Call Screening) Cancel*	✓	✓	
Night / Day (Lunch/Break) Service	✓	✓	

- * Available when the Digital Super Hybrid System is connected to a Digital Proprietary Telephone capable Panasonic Voice Processing System(one that supports digital proprietary telephone integration;e.g., KX-TVP100).

" ✓ " indicates that the feature is available.

Line Access Buttons

The following three types of CO buttons can be used to seize a outside line when making a call.

- **Single-CO (S-CO) button**
- **Group-CO (G-CO) button**
- **Loop-CO (L-CO) button**

Conditions

- A flexible CO button can be assigned as a Line Access Button (S-CO, G-CO or L-CO) in either System/Station Programming. Once a flexible CO button is assigned as a Line Access Button, it provides the line status condition by lighting patterns and green/red indication. Please refer to "LED Indication" in this section.
- You can set the G-CO and L-CO buttons on one telephone. Incoming and outgoing calls on the line are shown on the button in the following priority.
S-CO > G-CO > L-CO

Single-CO (S-CO) button

An S-CO button is a outside line access button. This allows you to access a specific outside line by pressing an S-CO button. An incoming outside call can be directed to an S-CO button.

Conditions

- The same outside line cannot be assigned to more than one S-CO button on a PT.
- It is possible to assign the same outside line to an S-CO button, a G-CO button and an L-CO button respectively.

User Manual References

- 2.2.2 Flexible Button Assignment
- 4.3.61 Outward Dialing, Line Access — SUMMARY

Group-CO (G-CO) button

To support efficient utilization of outside lines, a group of outside lines (outside line group) can be assigned to a CO button. This button is referred to as Group-CO (G-CO) button. Any incoming calls from any outside line in the same trunk group arrive at the G-CO button. To make a outside call, you can access an idle outside line in the trunk group by simply pressing the assigned G-CO button.

Conditions

- It is possible to assign the same outside line to an S-CO button, a G-CO button, and an L-CO button.
- It is necessary to program the extension for making and/or receiving calls in outside line groups.
- When your extension is assigned as an incoming call destination for a outside line, you cannot receive any incoming outside calls unless a G-CO, L-CO or S-CO button associated with the outside line is assigned.

User Manual References

2.2.2 Flexible Button Assignment

4.3.61 Outward Dialing, Line Access — SUMMARY

Loop-CO (L-CO) button

All outside lines can be assigned to a flexible CO button on a proprietary telephone. The assigned button serves as an L-CO button. An incoming call on any outside line arrives at the L-CO button, unless there are S-CO or G-CO buttons associated with the line or unless the button is already in use. To make a outside call, you simply press the dedicated L-CO button. Pressing the L-CO button provides the same operation as dialing an automatic line access code.

User Manual References

2.2.2 Flexible Button Assignment

4.3.61 Outward Dialing, Line Access — SUMMARY

1.1.5 Initial Setting for KX-T7400 Series

The Jog Dial can be used for the display contrast and the volume control. Rotate the Jog Dial in either direction as desired. The contrast or the volume level will change as follows.

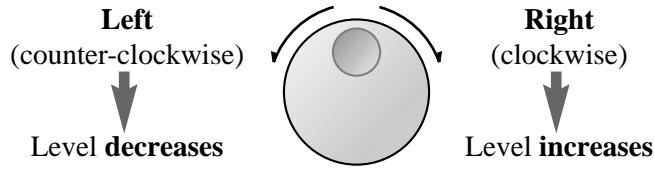

Display Contrast Adjustment

The MODE button and the Jog Dial for KX-T7431 users, and a Soft button and the Jog Dial for KX-T7433 and KX-T7436 users are used to adjust the display contrast. The contrast level is indicated on the display by the number of asterisks.

7431

While on-hook;



Press **MODE** six times.

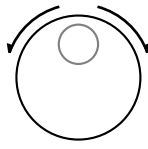

Rotate **Jog Dial** in the desired direction.

<PT Display Example>
 Contrast:*** (-contrast level 3)

7433 / 7436

While on-hook or during a conversation;

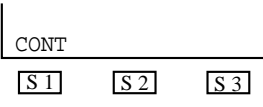

Press **CONT (S1)**.

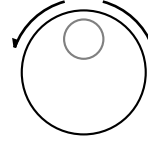

Rotate **Jog Dial** in the desired direction.

<PT Display Example>
 Contrast:*** (-contrast level 3)

When using the headset

The Panasonic Digital Super Hybrid System supports the use of a headset with a proprietary telephone (PT). When you use the headset (optional), you should switch the selection mode first. Selection is explained in the "Handset / Headset Selection" in Station Programming.

To change to the headset mode

Press: [PROGRAM] [9] [9] [9] [2] [STORE] [PROGRAM].

Changing the ringing tone of a CO button / Intercom calls

There are eight ringer frequencies available for each CO (Single-CO, Group-CO, Loop-CO) button and INTERCOM button. If you wish to change them, refer to "Ringing Tone Selection for CO Buttons", "Ringing Tone Selection for Intercom Calls" in Station Programming.

Volume Control — Handset Receiver/Headset/Ringer/Speaker

Allows you to adjust the following volumes as required.

- Handset Receiver volume (levels 1 through 4)
- Headset volume (levels 1 through 4)
- Ringer volume (levels 0 through 3)
- Speaker volume (levels 1 through 12)

If your digital proprietary telephone is provided with a display (display DPT), the volume level is indicated on the display by the number of asterisks. For ringer volume adjustment, three levels (OFF/LOW/HIGH) are available with the KX-T7420 and KX-T7425.

To adjust the handset receiver volume

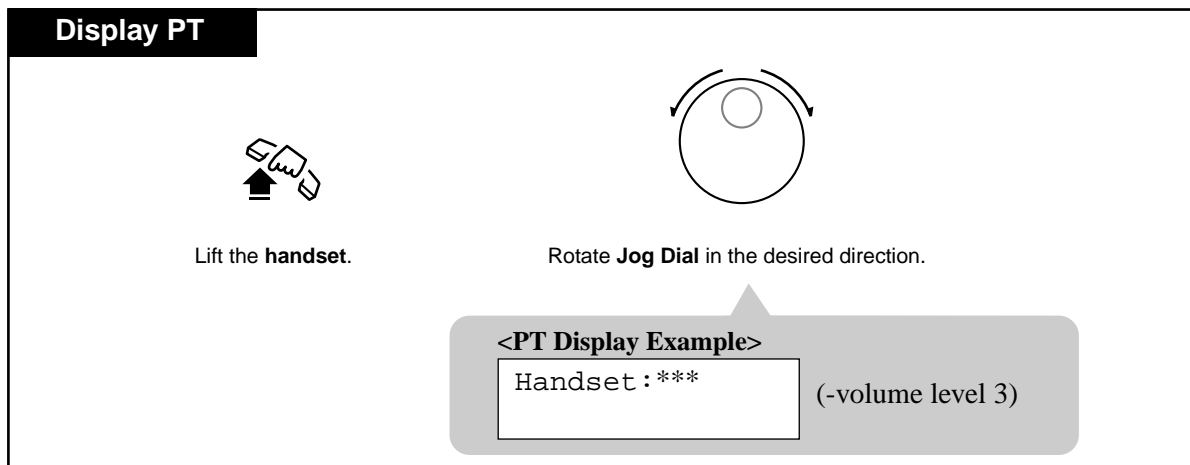

- You may also adjust the handset receiver volume during a conversation using the handset receiver.

To adjust the headset volume

Display PT

Be sure the headset is connected.



Press **SP-PHONE**. Rotate **Jog Dial** in the desired direction.

<PT Display Example>
Headset : *** (-volume level 3)

To adjust the ringer volume

7433 / 7436

While the telephone is ringing;

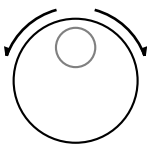

Rotate **Jog Dial** in desired direction.

<PT Display Example>
Ringer : *** (-volume level 3)

7433 / 7436

While the telephone is idle and on-hook;



Press **RING (S2)**. Rotate **Jog Dial** in the desired direction.

- The telephone will ring.
- The telephone will stop ringing in about 4 seconds.
- When the volume level is 0 (no "*" indication), the display shows "RNGOFF".

7431

While the telephone is idle and on-hook;



Press **MODE** five times.

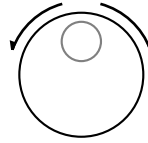

Rotate **Jog Dial** in the desired direction.

- The telephone will stop ringing in about 4 seconds.
- When the volume level is 0, no "*" is indicated.

<PT Display Example>

Ringer:*** (-volume level 3)

7420 / 7425

Adjust the **RINGER Volume Selector** lever to the desired setting (**OFF/LOW/HIGH**).

To adjust the speaker volume

74XX

Press **SP-PHONE**.

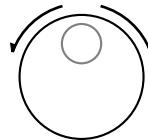

Rotate **Jog Dial** in the desired direction.

<PT Display Example>

SP:***** (-volume level 12)

You may also adjust the speaker volume while listening to background music (BGM On mode), receiving a voice call, receiving a page or hearing a call progress tone such as a dial tone.

Conditions

- **If the ringer volume of the KX-T7431 is set to OFF**, the display while on-hook is as follows.

Ring Off 12:00P

- By pressing "*", the display changes to show your extension number and name.

101: john Smith

1.1.6 Initial Setting for KX-T7200 Series

Display Contrast Adjustment (KX-T7230 and KX-T7235 only)

A Soft button and the VOLUME Control button are used to adjust the display contrast. The contrast level is indicated on the display by the number of asterisks. You can adjust the contrast level under the following conditions:

- a) When on-hook, or
- b) During an outside/intercom call.

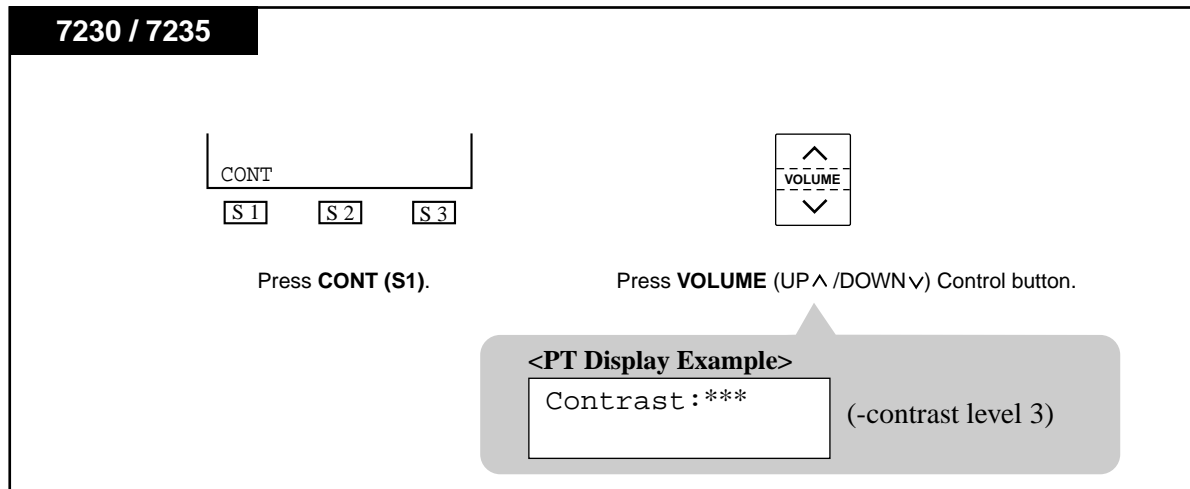

When using the headset

The Panasonic Digital Super Hybrid System supports the use of a headset with a proprietary telephone (PT). When you use the headset (optional), you should switch the selection mode first. Selection is explained in the "Handset / Headset Selection" in Station selection mode first. Selection is explained in the "Handset / Headset Selection" in Station Programming.

To change to the headset mode

Press: [PROGRAM] [9] [9] [9] [2] [STORE] [PROGRAM].

Changing the ringing tone of a CO button / Intercom calls

There are eight ringer frequencies available for each CO (Group-CO, Loop-CO, Single-CO) button and INTERCOM button. If you wish to change them, refer to "Ringing Tone Selection for CO Buttons" or "Ringing Tone Selection for Intercom Calls" in Station Programming.

Volume Control — Handset Receiver/Headset/Ringer/Speaker

Allows you to adjust the following volumes as necessary:

- Handset Receiver volume (level 1 through 3)
- Headset volume (level 1 through 3)
- Ringer volume (level 0 through 3)
- Speaker volume (level 1 through 12)

If your digital proprietary telephone is provided with a display (display DPT), the volume level is indicated on the display by the number of asterisks. For ringer volume adjustment, three levels (OFF/LOW/HIGH) are available with the KX-T7220 and KX-T7250.

To adjust the handset receiver volume

Display PT



Lift the **handset**.



Press **VOLUME** (UP ^ /DOWN v) Control button.

<PT Display Example>

Handset : *** (-volume level 3)

- You may also adjust the handset receiver volume during a conversation using the handset receiver.

To adjust the headset volume

Display PT

Be sure the headset is connected.



Press **SP-PHONE**.



Press **VOLUME** (UP ^ /DOWN v) Control button.

<PT Display Example>

Headset : *** (-volume level 3)

To adjust the ringer volume

7230 / 7235

While the telephone is ringing;



Press **VOLUME** (UP ^/DOWN V) Control button.

<PT Display Example>

Ringer:***

(-volume level 3)

7230 / 7235

While the telephone is idle and on-hook;

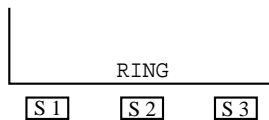

Press **RING (S2)**.



Press **VOLUME** (UP ^/DOWN V) Control button.

• The telephone will ring.

- The telephone will stop ringing in about 4 seconds.
- When the volume level is 0 (no "*" indication), the display shows "RNGOFF".

7220 / 7250



Adjust the **RINGER Volume Selector** lever to the desired setting (**OFF/LOW/HIGH**).

To adjust the speaker volume

72XX



Press **SP-PHONE** or **MONITOR**.

Press **VOLUME** (UP ^/DOWN ∨) Control button.

<PT Display Example>
SP : ***** (-volume level 12)

- You may also adjust the speaker volume while listening to background music (BGM On mode), receiving a voice call, receiving a page or hearing a call progress tone such as a dial tone.

1.1.7 LED Indication

The Light Emitting Diode (LED) buttons indicate the line conditions with lighting patterns.

Flashing light patterns

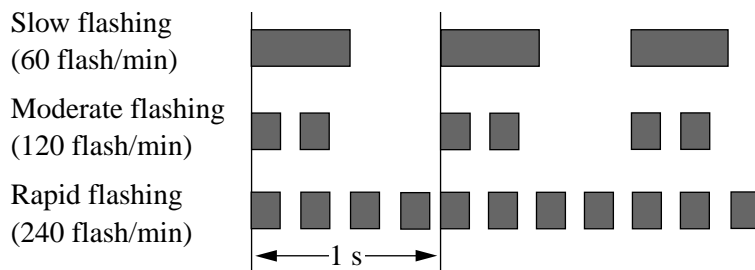

LED Indication on the INTERCOM Button

The table below shows the lighting patterns for intercom line conditions.

INTERCOM button	Intercom Line Condition
Off	Idle
Green On	Intercom call / Conference established
Green slow flashing	Intercom call hold
Green moderate flashing	Intercom call exclusive hold / Consultation hold
Green rapid flashing	Incoming intercom/doorphone call

LED Indication on the CO Button

The table below shows the lighting patterns for CO line conditions.

CO Button	Outside Line Condition
Off	Idle
Green On	You are using the line.
Green slow flashing	You have a held call.
Green moderate flashing	You have one of the following: (1) Exclusive hold, (2) Outside-to-Outside line call, or (3) Conference, unattended
Green rapid flashing	Privacy Release possible* / Hold Recall / Incoming call
Red On	Other-use / Log-out
Red slow flashing	Other-hold*

— Items marked with "*" are only available on the Single-CO button.

BLF on DSS Button

The Busy Lamp Field (BLF) indicator button is red when the corresponding extension is busy. This is available for Direct Station Selection (DSS) buttons on DSS consoles and for flexible CO buttons assigned as DSS buttons on proprietary telephones.

LED Indication on the FWD/DND Button

The table below shows the lighting patterns for the FWD/DND Button.

System Programming [990] Area (09), Bit (4,3)	When Call Forwarding (FWD) is set	When Do Not Disturb (DND) is set
11 (default)	Red Slow Flashing	Red On
10	Red On	Red On
01	Red On	Red Slow Flashing
00	Red Slow Flashing	Red Slow Flashing

Programming Guide Reference

[990] System Additional Information

Section 2

Station Programming

Note: All illustrations used in this section are based on model KX-T7235.

2.1 Station Programming Instructions

2.1.1 Station Programming Instructions

Station Programming allows you, the proprietary telephone (PT) users, to program certain features from your telephone individually. To program, you need to switch your telephone to the Station Programming mode. During programming mode, your telephone is in the busy condition to both inside and outside callers. If you want to make a normal call handling operation, you must finish the programming mode.

Programming Mode Display

When you enter into the Station Programming mode, the display shows the following message as the initial programming mode;

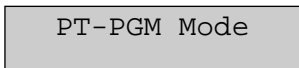

We recommend a PT with display for Station Programming to avoid mis-operation. The display also gives you helpful or stored data information related to your programming steps. In this section, we note the display example in the programming steps, if required. You can also refer to the "Display Examples" in the Appendix (Section 6).

Entering Station Programming mode

PT

Be sure that the telephone is idle and on-hook.

PROGRAM

9

9

Press **PROGRAM**. Dial 99.

- The STORE indicator lights.
- If 99 is not dialed within 5 seconds after the PROGRAM button is pressed, the Station Programming mode is canceled.

<PT Display Example>

PT-PGM Mode

—Initial programming display

- If there is no entry within one minute, the Station Programming mode is canceled and normal call handling mode resumes automatically.

Exiting Station Programming mode

PT

When the display shows the initial programming mode;

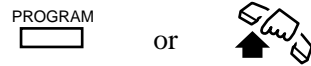

Press **PROGRAM** or lift the handset.

- To exit the Station Programming mode, press PROGRAM. You are in the call handling mode.

Confirming the assigned function data

— Be sure that you are in the Station Programming mode: Press [PROGRAM] [9] [9].

PT

program access number

HOLD

Enter the program access number. Press **HOLD (END)**.

- The display shows the initial programming mode.
- Enter the **program access number*** as follows.
 - 1: Preferred Line Assignment — Outgoing
 - 2: Preferred Line Assignment — Incoming
 - 3: Full One-Touch Dialing Assignment
 - 4: Intercom Alert Assignment
 - 5: Call Waiting Tone Type Assignment
 - 6: Self-Extension Number Confirmation
 - 7: Live Call Screening Mode Set[†]
 - 81: Initial Display Selection
 - 82: Bilingual Display Selection
 - 9: Handset/Headset Selection
 - 01: Remote Station Look Control (— Operator / Manager only)
 - 02: Call Log Lock Control, Incoming (— Operator / Manager only)
 - 03: Live Call Screening Password Control[†] (— Operator / Manager only)
 - #: Station Programming Data Default Set
- The display shows the programmed data.

<PT Display Example>
When you press [5], the display shows:

C.W. Tone1

(— The Call Waiting tone is currently programmed to Tone 1.)

* **A programming access number** is required to program/confirm the function data by Station Programming.
[†] : Available when the Digital Super Hybrid System is connected to a Digital Proprietary Telephone capable Panasonic Voice Processing System (one that supports digital proprietary telephone integration; e.g., KX-TVS100)

— To exit the Station Programming mode: Press [PROGRAM] or lift the handset.

— If you wish to change the data, follow the programming procedure explained in this section.

Confirming the assigned data on the Flexible button

— Be sure that you are in the Station Programming mode: Press [PROGRAM] [9] [9].

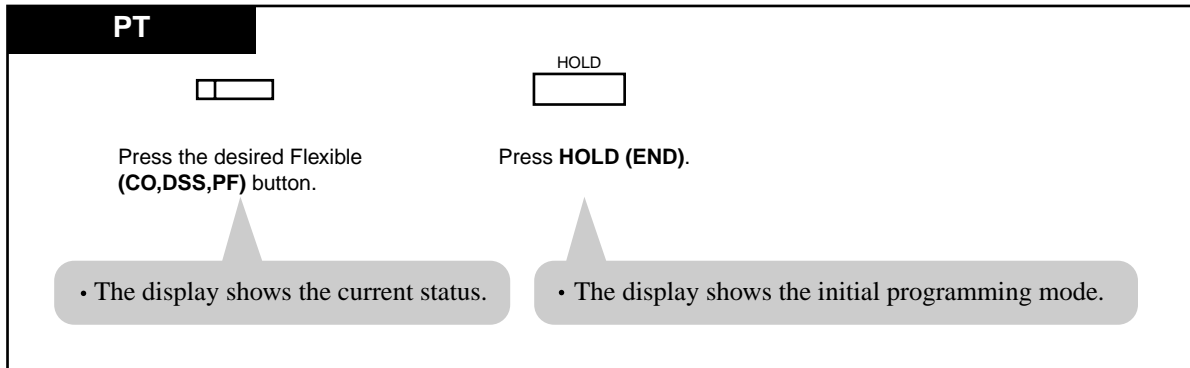

— To exit Station Programming mode: Press [PROGRAM] or lift the handset.

— If you wish to change the data, follow the programming procedure explained in this section.

Clearing the data on the Flexible button

— Be sure that you are in the Station Programming mode: Press [PROGRAM] [9] [9].

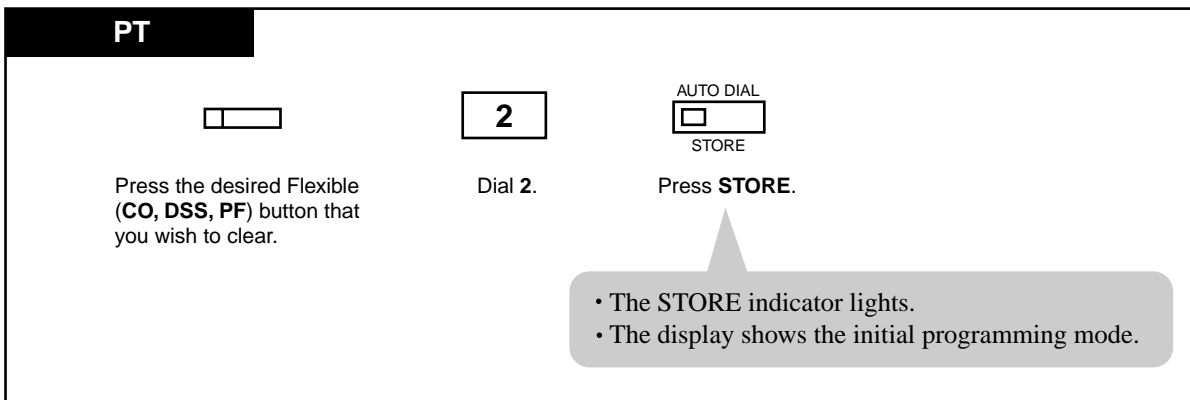

— To exit Station Programming mode: Press [PROGRAM] or lift the handset.

— The lists on the following pages are the buttons and programming access numbers used for Station Programming. Detailed operating instructions are explained on each page in this section.

Station Programming [Flexible Button Assignment]

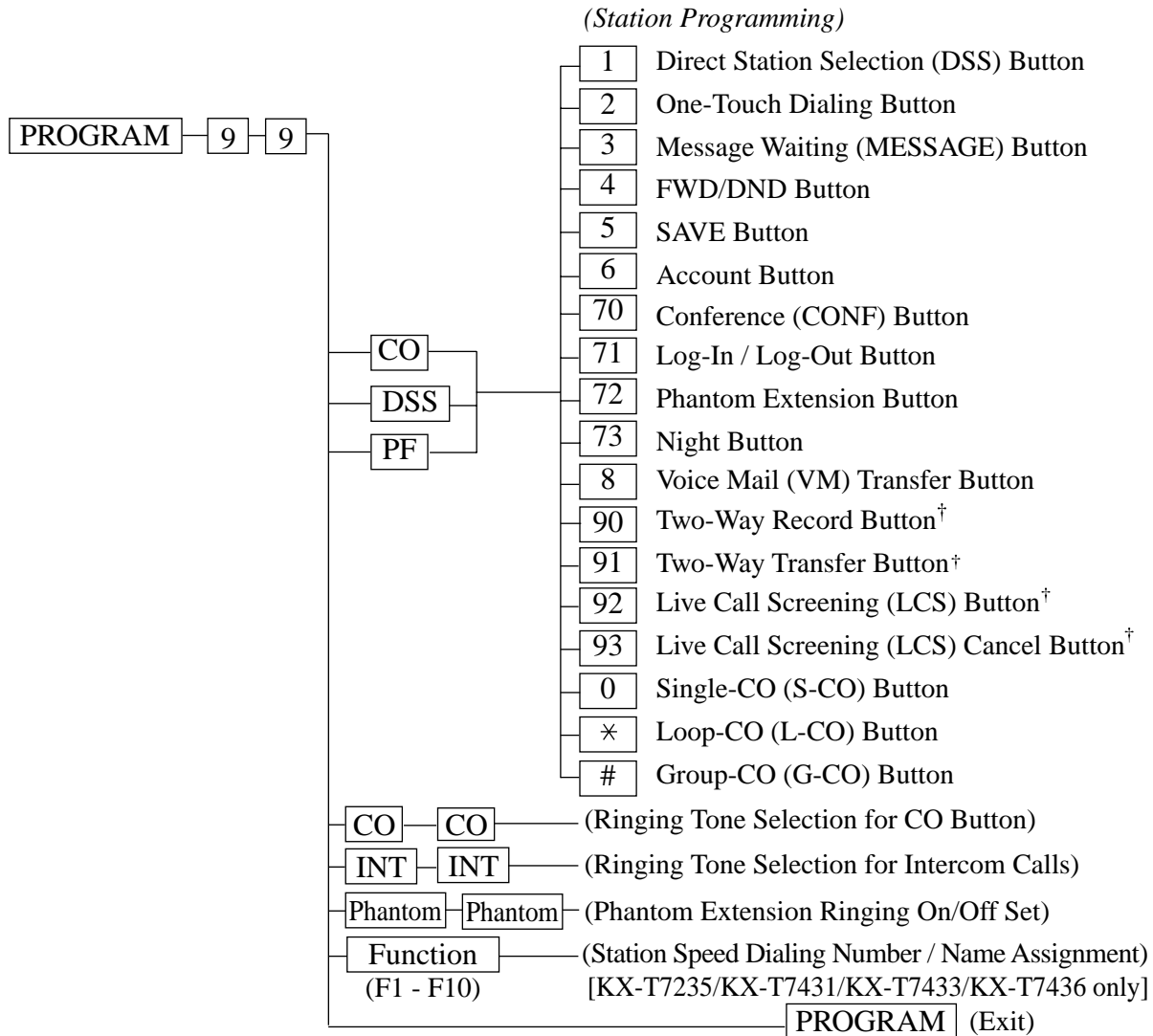

[†]: Available when the Digital Super Hybrid System is connected to a Digital Proprietary Telephone capable Panasonic Voice Processing System (one that supports digital proprietary telephone integration; e.g., KX-TVSI00).

Station Programming [Function Assignment]

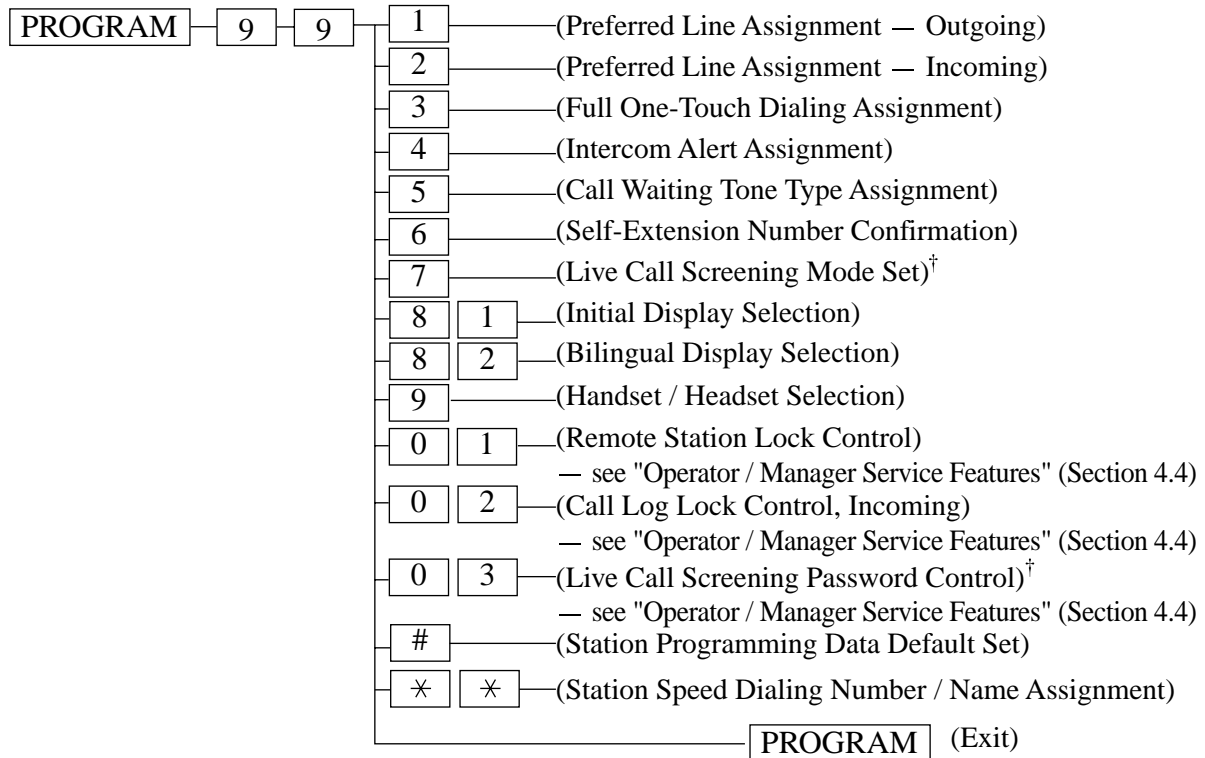

†: Available when the Digital Super Hybrid System is connected to a Digital Proprietary Telephone capable Panasonic Voice Processing System (one that supports digital proprietary telephone integration; e.g., KX-TVS100).

2.2 Station Programming

2.2.1 Initial Settings

The original setting are shown in bold letters in the shaded boxes. Find and mark your desired selections for programming.

— Be sure that you are in the Station Programming mode : Press [PROGRAM] [9] [9].

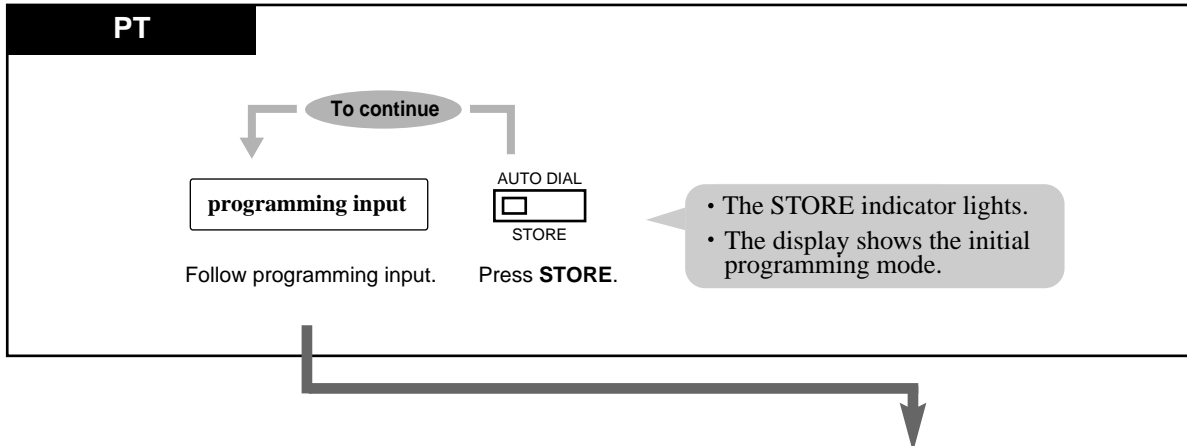

Item	Selection	Programming Input
Preferred Line Assignment – Outgoing Which line do you prefer to seize when you go off-hook to make calls?	<input type="checkbox"/> No line	[1] [1]
	<input type="checkbox"/> An idle outside line	[1] [2]
	<input type="checkbox"/> A pre-assigned outside line	[1] [3] Outside line no. 01–08 (for KX-TD816) 01–48 (for KX-TD1232)
	<input type="checkbox"/> The Intercom line	[1] [INTERCOM]

Item	Selection	Programming Input
Preferred Line Assignment – Incoming Which line do you prefer to seize when you go off-hook to receive calls?	<input type="checkbox"/> No line	<input type="text" value="2"/> <input type="text" value="1"/>
	<input type="checkbox"/> A ringing line	<input type="text" value="2"/> <input type="text" value="2"/>
	<input type="checkbox"/> A pre-assigned outside line	<input type="text" value="2"/> <input type="text" value="3"/> <small>Outside line no. 01–08 (for KX-TD816) 01–48 (for KX-TD1232)</small>
Full One-Touch Dialing Assignment Which way do you prefer to dial the One-Touch Dialing feature?	<input type="checkbox"/> Going Off-hook and then pressing the One-Touch Dialing button.	<input type="text" value="3"/> <input type="text" value="1"/>
	<input type="checkbox"/> Pressing the One-Touch Dialing button.	<input type="text" value="3"/> <input type="text" value="2"/>
Intercom Alert Assignment Which way do you prefer to receive an intercom call?	<input type="checkbox"/> Ringling	<input type="text" value="4"/> <input type="text" value="1"/>
	<input type="checkbox"/> Directly – the party's voice is heard without ringing.	<input type="text" value="4"/> <input type="text" value="2"/>
Call Waiting Tone Type Assignment Do you prefer to distinguish the Call Waiting tone from an outside line and an intercom call?	<input type="checkbox"/> No. Use the same tone. (Call Waiting Tone 1)	<input type="text" value="5"/> <input type="text" value="1"/>
	<input type="checkbox"/> Yes. Use a different tone. (Call Waiting Tone 2)	<input type="text" value="5"/> <input type="text" value="2"/>
Live Call Screening Mode Set Which voice mail service do you prefer when a caller is recording a message in your mailbox?	<input type="checkbox"/> You can monitor the message through the telephone speaker. (Hands-free mode)	<input type="text" value="7"/> <input type="text" value="1"/>
	<input type="checkbox"/> Only an alert tone is heard. (Private mode)	<input type="text" value="7"/> <input type="text" value="2"/>
Initial Display Selection Which display do you prefer when a call is received?	<input type="checkbox"/> Caller ID	<input type="text" value="8"/> <input type="text" value="1"/> <input type="text" value="1"/>
	<input type="checkbox"/> Outside line name	<input type="text" value="8"/> <input type="text" value="1"/> <input type="text" value="2"/>
	<input type="checkbox"/> DID extension name	<input type="text" value="8"/> <input type="text" value="1"/> <input type="text" value="3"/>
Bilingual Display Selection Which language display do you prefer?	<input type="checkbox"/> English	<input type="text" value="8"/> <input type="text" value="2"/> <input type="text" value="1"/>
	<input type="checkbox"/> French	<input type="text" value="8"/> <input type="text" value="2"/> <input type="text" value="2"/>
Handset/Headset Selection Which equipment will you use as a receiver?	<input type="checkbox"/> Handset	<input type="text" value="9"/> <input type="text" value="1"/>
	<input type="checkbox"/> Headset	<input type="text" value="9"/> <input type="text" value="2"/>

— To exit the Station Programming mode: Press [PROGRAM] or lift the handset.

2.2.2 Flexible Button Assignment

— Be sure that you are in the Station Programming mode: Press [PROGRAM] [9] [9].

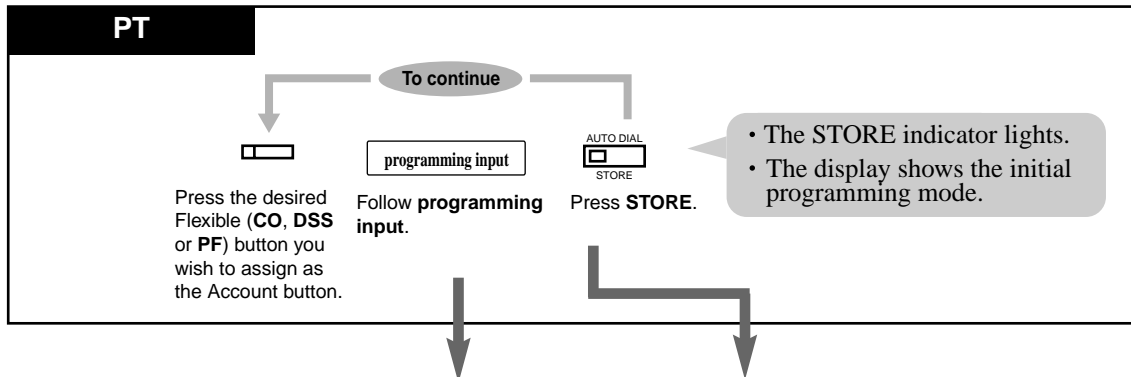

Button	Programmable Button			Programming Input	
	CO	DSS	PF		
Direct Station Selection (DSS)	✓	✓		[1]	Extension no.
One-Touch Dialing	✓	✓	✓	[2]	Desired no. *1 (max. 16 digits)
MESSAGE	✓	✓		[3]	
FWD/DND (Forward/Do Not Disturb)	✓	✓	✓	[4]	
SAVE	✓	✓	✓	[5]	
Account	✓	✓	✓	[6]	
CONF (Conference)	✓	✓	✓	[7] [0]	
Log-In/Log-Out	✓			[7] [1]	
Phantom Extension	✓	✓		[7] [2]	Phantom extension no.
Night	✓	✓		[7] [3]	
Voice Mail Transfer *2	✓	✓	✓	[8]	Voice mail extension no.
Two-Way Record *2	✓	✓		[9] [0]	Voice mail extension no.
Two-Way Transfer *2	✓	✓		[9] [1]	Voice mail extension no.
Live Call Screening *2	✓	✓		[9] [2]	
Live Call Screening Cancel *2	✓	✓		[9] [3]	
Single-CO	✓			[0]	Outside line no. 01-08 (for KX-TD816) 01-48 (for KX-TD1232)
Loop-CO	✓			[*]	
Group-CO	✓			[#]	Outside line group no. (1-8)

— To exit the Station Programming mode: Press [PROGRAM] or lift the handset.

Conditions

- *¹ "×", "#", FLASH, PAUSE, SECRET (INTERCOM) and — (CONF) can also be stored.
 - If you do not want to display the stored number, press the SECRET (INTERCOM) button before and after the numbers you wish to conceal.
 - If you store an external party's number, you should first store a line access number (9, 81 to 88).
 - If you need to enter an account code, you can enter the specified account code before the line access number.

<Example>

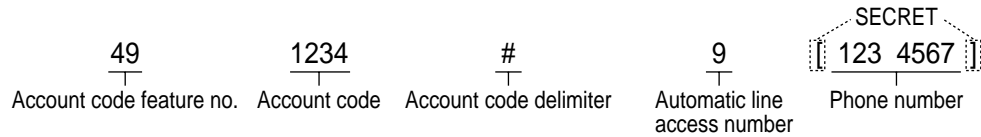

- *² This button is used for the voice mail integration feature.
- To exit the mode at any time, lift the handset.

2.2.3 Phantom Extension Ringing On/Off Set

Allows you to assign a ringing On/Off function on a Phantom button (default: On).

— Be sure that you are in the Station Programming mode: Press [PROGRAM] [9] [9].

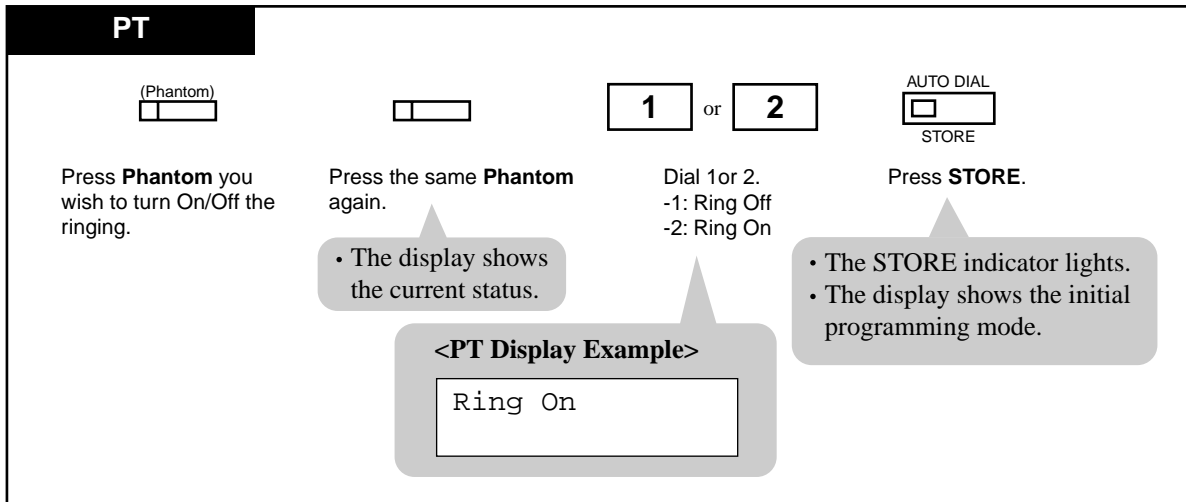

— To exit the Station Programming mode: Press [PROGRAM] or lift the handset.

2.2.4 Ringing Tone Selection for CO Buttons

Allows you to assign a ringer frequency to each CO (default: tone type 2).

— Be sure that you are in the Station Programming mode: Press [PROGRAM] [9] [9].

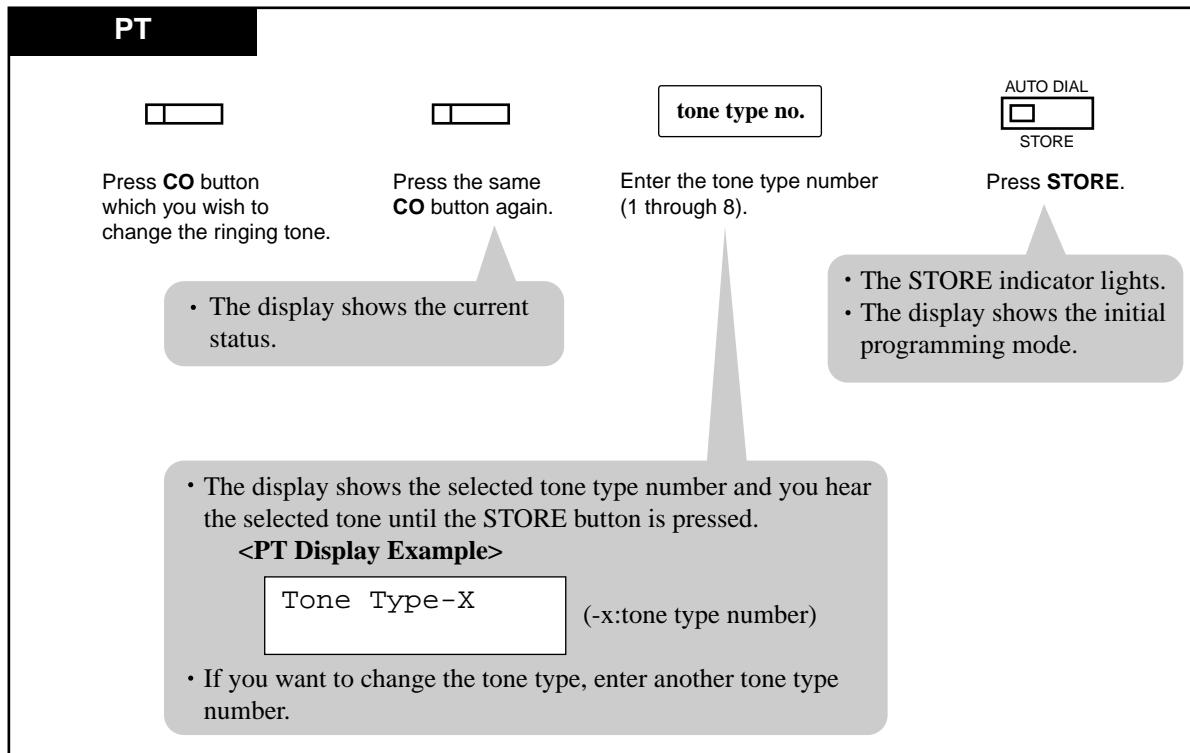

— To exit the Station Programming mode: Press [PROGRAM] or lift the handset.

2.2.5 Ringing Tone Selection for Intercom Calls

Allows you to assign a ringer frequency for intercom call (default: tone type 3).

— Be sure that you are in the Station Programming mode: Press [PROGRAM] [9] [9].

PT



Press **INTERCOM**.



Press **INTERCOM** again.

tone type no.

Enter the tone type number
(1 through 8).



Press **STORE**.

- The display shows the current status.
- The display shows the selected tone type number and you hear the selected tone until the STORE button is pressed.

<PT Display Example>

Tone Type-X
(-x:tone type number)

- If you want to change the tone type, enter another tone type number.

- The STORE indicator lights.
- The display shows the initial programming mode.

— To exit the Station Programming mode: Press [PROGRAM] or lift the handset.

2.2.6 Self-Extension Number Confirmation

Allows you to display your extension port physical number and extension number.

— Be sure that you are in the Station Programming mode: Press [PROGRAM] [9] [9].

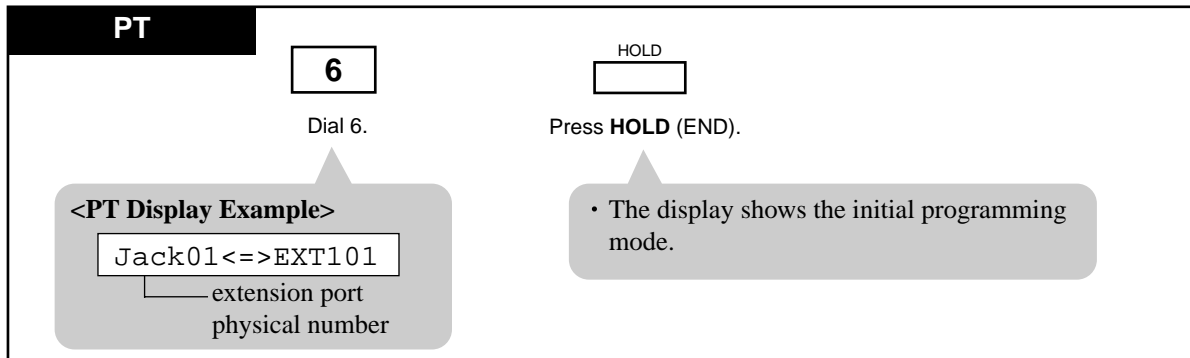

— To exit the Station Programming mode: Press [PROGRAM] or lift the handset.

2.2.7 Station Programming Data Default Set

Allows you to return each of the following items assigned by Station Programming to their default settings.

- a) Bilingual Display Selection (default: English)
- b) Call Waiting Tone Type Assignment (default: Tone 1)
- c) Full One-Touch Dialing Assignment (default: on)
- d) Handset/Headset Selection (default: Handset)
- e) Initial Display Selection (default: Caller ID)
- f) Intercom Alert Assignment (default: Ring Call)
- g) Live Call Screen Mode Set (default: Hands-free)
- h) Preferred Line Preference — Incoming (default: Ringing Line)
- i) Preferred Line Preference — Outgoing (default: INTERCOM Line)

— Be sure that you are in the Station Programming mode: Press [PROGRAM] [9] [9].

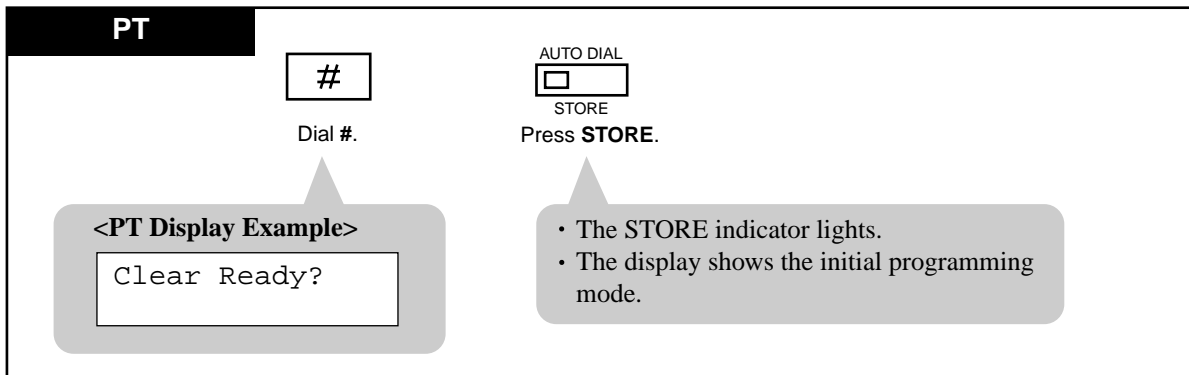

— To exit the Station Programming mode: Press [PROGRAM] or lift the handset.

2.2.8 Station Speed Dialing Number/Name Assignment [KX-T7235/ KX-T7431/KX-T7433/KX-T7436 only]

Allows you to assign frequently dialed numbers and names to each Function button on your PT.

For KX-T7235 and KX-T7436 users

To store a number

— Be sure that you are in the Station Programming mode: Press [PROGRAM] [9] [9].

7235 / 7436

F1	PT-PGM Mode	F6
F2		F7
F3		F8
F4		F9
F5		F10

Press **Function** (F1-F10).

desired number

Enter the desired number
(extension number,
phone number, etc.).

AUTO DIAL
 STORE

Press **STORE**.

- The STORE indicator light turns off.
- The display shows the current status.
(If nothing is stored, "Not Stored" is displayed.)

<PT Display Example>

9-123-4567
 CLR NEXT

(—Outside number, 123-4567,
is now programmed.)

- Up to 16 digits, consisting of 0 through 9, *, #, FLASH, PAUSE, INTERCOM, ("[" or "]" : secret) and CONF (-:hyphen), can be stored.
- To store the telephone number of an outside party, the line access code (9 or 81 through 88) must be stored as the leading digit.
- To erase the entry, press the **CLR (S2)** button.
- To store a name, press the **NEXT(S3)** button and go to step 3 in "To store a name" as described in the following procedure.

— To exit the Station Programming mode: Press [PROGRAM] or lift the handset.

To store a name

— Be sure that you are in the Station Programming mode: Press [PROGRAM] [9] [9].

7235 / 7436

F1	PT-PGM Mode	F6
F2		F7
F3		F8
F4		F9
F5		F10

Press **Function** (F1-F10).

S 1 S 2 S 3

Press **NEXT** (S3).

desired name

Enter the **name**.

- The STORE indicator light turns off.
- The display shows the current status.

- The display shows the current status. (If nothing is stored, "Not Stored" is displayed.)

<PT Display Example>

Mike Graham
 CLR NEXT

(— Name is now programmed.)

AUTO DIAL

STORE

Press **STORE**.

The STORE indicator lights.
The display shows the initial programming mode.

Refer to the Combination Tables 1 and 2 in 2.2.8 Station Speed Dialing Number/Name Assignment [KX-T7235/KX-T7431/KX-T7433/KX-T7436 only] for information on how to enter each character.

— To exit the Station Programming mode: Press [PROGRAM] or lift the handset.

For KX-T7431 and KX-T7433 users

To store a number

— Be sure that you are in the Station Programming mode: Press [PROGRAM] [9] [9].

7431 / 7433

*

*

Dial **.

station speed dial no.

Enter a **station speed dial number** (0 through 9).

desired number

Enter the **desired number** (extension number, phone number, etc.).

AUTO DIAL

STORE

Press **STORE**.

- The STORE indicator light turns off.
- The display shows the current status.
(If nothing is stored, "Not Stored" is displayed.)

<PT Display Example>

9-123-4567

CLR NEXT

(—Outside number, 123-4567, is now programmed.)

- The STORE indicator lights.
- The display shows the initial programming mode.

- Up to 16 digits, consisting of 0 through 9, *, #, FLASH, PAUSE, INTERCOM, ("[" or "]" : secret) and CONF (-:hyphen), can be stored.
- To store the telephone number of an outside party, the line access code (9 or 81 through 88) must be stored as the leading digit.
- To erase the entry, press the **CLR (S2)** button or **TRANSFER** button.
 - CLR (S2) button: for KX-T7433 users
 - TRANSFER button: for KX-T7431 users
- To store a name, press the **NEXT (S3)** button (KX-T7433) or **MODE** button (KX-T7431) and go to step 4 in "To store a name" as described in the following procedure.

— To exit the Station Programming mode: Press [PROGRAM] or lift the handset.

To store a name

— Be sure that you are in the Station Programming mode: Press [PROGRAM] [9] [9].

7431 / 7433

✖

✖

Dial ✖✖.

station speed dial no.

Enter a **station speed dial number** (0 through 9).

NEXT

S1

S2

S3

Press **NEXT (S3) or MODE.**

- The STORE indicator light turns off.
- The display shows the current status. (If nothing is stored, "Not Stored" is displayed.)

<PT Display Example>

Mike Graham
(— Name is now programmed.)

CLR
NEXT

desired name

Enter the **name**.

AUTO DIAL

STORE

Press **STORE.**

- The STORE indicator lights.
- The display shows the initial programming mode.

MODE

OR

- **NEXT(S3)** button: for KX-T7433 users
- **MODE** button: for KX-T7431 users

Refer to the Combination Tables 1 and 2 in 2.2.8 Station Speed Dialing Number/Name Assignment [KX-T7235/KX-T7431/KX-T7433/KX-T7436 only] for information on how to enter each character.

— To exit the Station Programming mode: Press [PROGRAM] or lift the handset.

Combination Table

Each character can be entered by using the dial key pad, various buttons or the Jog Dial for storing names.

Combination Table 1 shows the combination of the keys and the number of times to press the SELECT (AUTO ANSWER/MUTE) button, or the combination of the key and the SHIFT and Soft buttons to enter each character. (The AUTO ANSWER/MUTE button becomes the SELECT button when using the overlay.)

To enter a character, find the key and number of times to press the SELECT button or the corresponding SHIFT and Soft button combination from the table. Press the corresponding key first, then press the SELECT button the required number of times. Or you can use the SHIFT button and a Soft button (S1 through S3) instead of the SELECT button.

Combination Table 2 shows the combination of keys and the number of pulses to move the Jog Dial (click tones) to the right. To enter a character, find the key and number pulses to rotate the Jog Dial. Press the corresponding key first, then rotate the Jog Dial the required number of times. Or, if you keep rotating the Jog Dial after pressing any dialing key, all of the characters in the table will be displayed.

Combination Table 1

SHIFT & Soft Combination		S1	SHIFT + S1	S2	SHIFT + S2	S3	SHIFT+ S3	SHIFT+ SHIFT+ S1	SHIFT+ SHIFT+ S2
Pressing SELECT (Times)*	0	1	2	3	4	5	6	7	8
Keys									
1	1	Q	q	Z	z	!	?		
2	2	A	a	B	b	C	c		
3	3	D	d	E	e	F	f		
4	4	G	g	H	h	I	i		
5	5	J	j	K	k	L	l		
6	6	M	m	N	n	O	o		
7	7	P	p	Q	q	R	r	S	s
8	8	T	t	U	u	V	v		
9	9	W	w	X	x	Y	y	Z	z
0	0		.	,	'	:	;		
*	*	/	+	-	=	<	>		
#	#	\$	%	&	@	()		

* If your telephone is a KX-T7431, do not use the provided SELECT button. Use the AUTO ANSWER / MUTE button which becomes the SELECT button when using the overlay.

Combination Table 2

Rotating Jog Dial (Pulses)	0	1	2	3	4	5	6	7	8
keys									
1	1	Q	q	R	r	S	s	T	t
2	2	A	a	B	b	C	c	D	d
3	3	D	d	E	e	F	f	G	g
4	4	G	g	H	h	I	i	J	j
5	5	J	j	K	k	L	l	M	m
6	6	M	m	N	n	O	o	P	p
7	7	P	p	Q	q	R	r	S	s
8	8	T	t	U	u	V	v	W	w
9	9	W	w	X	x	Y	y	Z	z
0	0		!	?	.	,	'	:	;
*	*	/	+	-	=	<	>	#	\$
#	#	\$	%	&	@	()	A	a

<Example>

— Using the SELECT button;

See Combination Table 1.

1) Press 6 and then press the SELECT button once to enter "M".

2) Press 4 and then press the SELECT button six times to enter "i".

3) Press 5 and then press the SELECT button four times to enter "k".

4) Press 3 and then press the SELECT button four times to enter "e".

— Using the SHIFT button and a Soft button;

See Combination Table 1.

1) Press 6 and then press the S1 button to enter "M".

2) Press 4 and then press the SHIFT and S3 button to enter "i".

3) Press 5 and then press the S2 button to enter "k".

4) Press 3 and then press the S2 button to enter "e".

— Using the Jog Dial (With a KX-T7431 / KX-T7433 / KX-T7436 only)

See Combination Table 2.

1) Press 6 and then rotate the Jog Dial *one* pulse to enter "M".

2) Press 4 and then rotate the Jog Dial *six* pulse to enter "i".

3) Press 5 and then rotate the Jog Dial *four* pulse to enter "k".

4) Press 3 and then rotate the Jog Dial *four* pulse to enter "e".

OR

- 1) Press 2 and then rotate the Jog Dial until "M" appears.
- 2) Press 2 and then rotate the Jog Dial until "i" appears.
- 3) Press 2 and then rotate the Jog Dial until "k" appears.
- 4) Press 2 and then rotate the Jog Dial until "e" appears.

Note

- Pressing the SHIFT button alternates between capital and lower case letters. Once this button is pressed, that letter SHIFT mode remains until SHIFT is pressed again.
- To erase the last word (to backspace), press the CONF button.
(The CONF button becomes the "←"(backspace) key when using the overlay.)
- To erase all of the data, press the CLR (S2) button.
- If you keep rotating the Jog Dial, all of the characters will be displayed in order.
<Example> If you rotate the Jog Dial after pressing 2, all of the characters will appear in the following order:
A a B b ... Z z (space) ! ? . , ' : ; * / + - = < > # \$ % & @ () A a B b ...

Conditions

- The default is "Not Stored".
- Up to 10 dialing numbers and names can be assigned. Each dialing number has a maximum of 16 digits and each name has a maximum of 10 characters.

Section 3

User Programming

3.1 User Programming Instructions

3.1.1 General Programming Instructions

User Programming allows you, any extension user who knows the User Programming Password, to program the following system features from your telephone individually.

- [000] Date and Time Set
- [001] System Speed Dialing Number Set
- [002] System Speed Dialing Name Set
- [003] Extension Number Set
- [004] Extension Name Set
- [005] Flexible CO Button Assignment
- [006] Operator / Manager Extension Assignment
- [007] DSS Console Port and Paired Telephone Assignment
- [008] Absent Messages
- [009] Quick Dial Number Set
- [012] ISDN Extension Number Set
- [013] ISDN Extension Name Set
- [014] VM Name Set
- [017] DISA User Codes

To program, you need to switch your telephone to the User Programming mode. During the programming mode, your telephone is in a busy condition for outside callers. If you want to make a normal call operation, you must finish the programming mode.

Default Setting

This system has default factory settings. Any required changes can be written in the "Programming Tables."

Required Telephone Set

One of the following Proprietary Telephone (PT) sets with display is required for User Programming:

- Digital Proprietary Telephone (DPTs): KX-T7436, KX-T7433, KX-T7431, KX-T7235, KX-T7230.

Soft Buttons and SHIFT Button on the Display PT

Three soft buttons are provided just below the display of the following Digital Proprietary Telephones (DPTs): KX-T7230, KX-T7235, KX-T7433, KX-T7436.

Functions of these Soft buttons vary as the programming procedures advance step by step. Those functions that are currently assigned to the buttons are shown on the lower line of the display. If the **SHIFT** button indicator is on, two functions are available for each Soft button. To alternate between the two functions, press the **SHIFT** button on the right side of the display.

Using the Overlay

A programming overlay is packed with the telephone at the factory. This overlay should be used at all times in the programming mode since the functions of the telephone keys change during programming.

Location of Controls with the Overlay

The pictures below show the functions of the buttons of the KX-T7433, KX-T7436, KX-T7230 and KX-T7235 in the programming mode. KX-T7431 is the same as KX-T7433 except for the Soft and SHIFT buttons.

KX-T7431

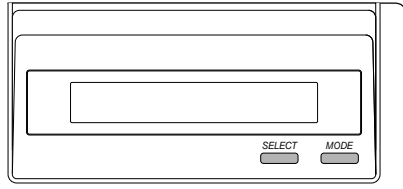

KX-T7433

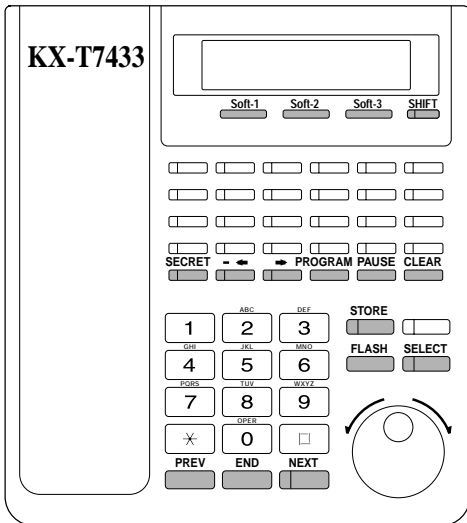

KX-T7436

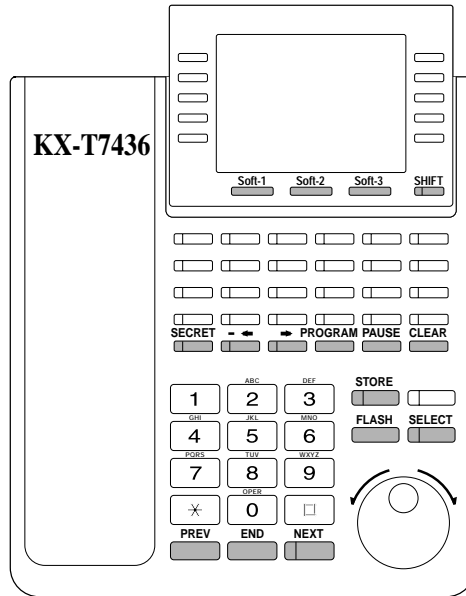

KX-T7230

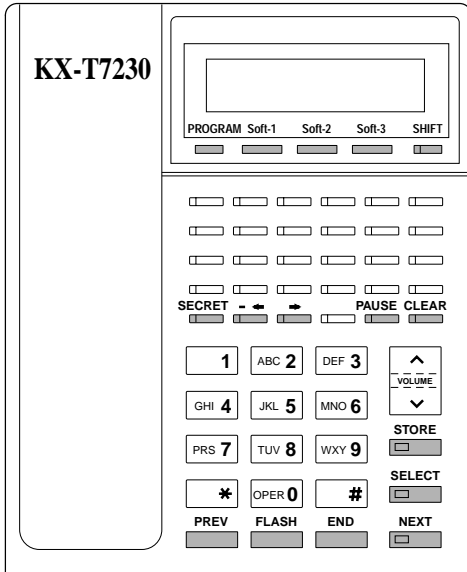

KX-T7235

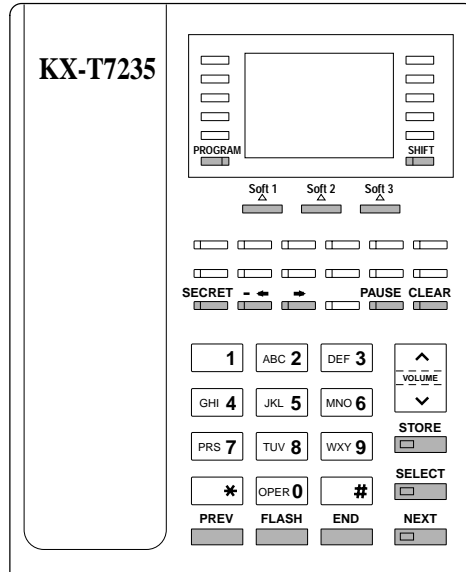

Before entering the user programming mode

Before entering the user programming mode, confirm that:

- Your telephone is on-hook, and
- No calls are on hold at your telephone.

Entering the user programming mode

To enter the User Programming mode:

Press PROGRAM + * + * + User Programming Password (default:1234)

- The display shows the Initial Message: USR-PGM NO? →

Note

- If nothing is entered within five seconds after the PROGRAM button is pressed, programming mode is canceled.
- During the programming mode, your extension is treated as a busy extension.
- Only one proprietary telephone can be in programming mode at any one time.
- The User Programming Password is not shown on the display for security reason. The password can be changed by System Programming.

Programming Guide References

[120] User Password

In this section, programs [001] through [004] are explained. Please consult with your dealer when you need to change the following programs:

- [005] Flexible CO Button Assignment
- [006] Operator / Manager Extension Assignment
- [007] DSS Console Port and Paired Telephone Assignment
- [008] Absent Messages
- [009] Quick Dial Number Set
- [012] ISDN Extension Number Set
- [013] ISDN Extension Name Set
- [014] VM Name Set

3.1.2 Programming Methods

Advancing to the next stage

When "USR-PGM NO?→" is displayed, you can select one of the following:

- To go to program [000], press the **NEXT** button.
- To go to another program, enter the 3-digit program address.

Rotation of jack number

Each jack of the Digital Super Hybrid System supports the connection of a digital proprietary telephone and a single line device with different extension numbers (eXtra Device Port: XDP function). To program this function it is necessary to assign two parts for each jack. The first part of jack one is 01-1. The second part of jack one is 01-2. The first part of jack two is 02-1 and so on. The **NEXT** and **PREV** buttons can be used to move from jack to jack as required.

Example

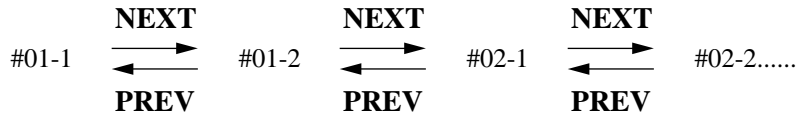

Note

The first part of a jack is for a DPT of a XDP-assigned jack. The second part is for a single line device. Program [600] EXtra Device Port assigns which jacks are XDP.

Entering Characters

You can enter characters to store names for speed dial numbers, extension numbers, etc., by using the dialing key pad and buttons.

Each of the twelve dialing keys on the dialing key pad represents seven characters. Refer to 2.2.8 Station Speed Dialing Number/Name Assignment [KX-T7235/KX-T7431/KX-T7433/KX-T7436 only].

Storing your data

Press **STORE** to store your data.

- The **STORE** indicator lights red and a confirmation tone sounds.
- * **Confirmation tone (one beep)**
After pressing **STORE**, you will hear a beep. This informs you that storage has been completed successfully.
- * **Alarm tone (three beeps)**
If you hear this alarm, your entry is not valid.

Making another selection within the same program address

- To go to the next selection, press **NEXT**.
- To go to the previous selection, press **PREV**.
- To make a specific selection, press **SELECT** and then enter the number.

Accessing another program address

After pressing **STORE**, you can access another program by one of the following two methods:

a) To go to the next program address:

- **Larger program address**

<KX-T7200 series>

Press **Soft 1 (SKP+)** or **VOLUME ∨(DOWN)**.

<KX-T7400 series>

Rotate the **Jog Dial** counterclockwise.

- **Smaller program address**

<KX-T7200 series>

Press **SHIFT + Soft 1 (SKP-)** or **VOLUME ^ (UP)**.

<KX-T7400 series>

Rotate the **Jog Dial** clockwise.

b) To go to a specific program address:

Press **END**, then enter the program address.

Returning to the operation mode

1. Lift the handset while in programming mode.
2. When the Initial Message: **USR-PGM NO? →** is displayed, press the **PROGRAM** button.
(To display the Initial Message, press **END**.)

3.2 User Programming

3.2.1 [000] Date and Time Set

Notice

It is assumed that you have read Section 3.1 "User Programming Instructions". Soft button usage is explained in that section, therefore no references will be made to them in the following instructions. The soft buttons can be used in place of the overlay keys at any time.

Description

Sets the current date and time.

Selection

- Year: **00 through 99**
- Month: **Jan. through Dec.**
- Day: **1 through 31**
- Day of the week: **SUN / MON / TUE / WED / THU / FRI / SAT**
- Hour: **01 through 12**
- Minute: **00 through 59**
- **AM / PM**
- Hour format: **12 or 24**

Default

'93 Jan. 1 FRI 12:00 AM 12

Programming

Display PT

<Date Setting>

0

0

0

Dial **000**.

NEXT

□

Press **NEXT**.

year

□

Enter the **year**
(last 2 digits).

→

Press →.

<PT Display>

000 DATE / TIME

<PT Display Example>

'01 Jan. 1 MON

- To change the current entry, press **CLEAR** and enter the new year.

SELECT

□

Keep pressing **SELECT** until the desired month is displayed.

→

Press →.

day

□

Enter the **day**
(01 through 31).

→

Press →.

SELECT

□

Keep pressing **SELECT** until the desired day of the week is displayed.

- To change the current entry, press **CLEAR** and enter the new day.

STORE

□

Press **STORE**.

NEXT

□

Press **NEXT**.

hour

□

Enter the **hour**
(00 through 12).

→

Press →.

minute

□

Enter the **minute**
(00 through 59).

<PT Display Example>

12:00 AM 12

- To change the current entry, press **CLEAR** and enter the new hour.

- To change the current entry, press **CLEAR** and enter the new minute.

→

Press →.

SELECT

□

Press **SELECT** for AM or PM.

→

Press →.

SELECT

□

Press **SELECT** for 12 or 24 (hour format).

STORE

□

Press **STORE**.

END

□

Press **END**.

Conditions

- After changing an entry, you can press **STORE**. You do not have to perform the rest of the steps.
- To return to the previous field, press **←** in steps 4 through 9 and steps 13 through 18.
- If you hear an alarm after pressing **STORE**, check that the date is valid.
- The clock starts immediately after the **STORE** button is pressed.
- You cannot leave an entry empty.

Features Guide References

Display, in Idle

3.2.2 [001] System Speed Dialing Number Set

Description

Used to program the System Speed Dialing numbers. These numbers are available for any extension user in the system.

Selection

- Speed dial numbers: **000 through 499**
- Telephone number: **24 digits (max.)**

Default

All speed dial numbers — Not Stored

Programming

Display PT

0

0

1

Dial **001**.

<PT Display>

001 SYS SPD DIAL

NEXT

Press **NEXT**.

<PT Display>

SPD Code?→

speed dial no.

Enter a **speed dial number**
(000 through 499).

- To enter speed dial number 000, you can also press NEXT.

<PT Display Example>

000:Not Stored

Repeat these steps

telephone no.

Enter a **telephone number**.

- To delete the current entry, press CLEAR.
- To change the current entry, press CLEAR and enter the new number.

STORE

Press **STORE**.

<To continue:> [When SELECT is pressed]

NEXT

PREV

SELECT

Press **NEXT** or **PREV** or **SELECT**.

speed dial no.

Enter the desired **speed dial number**
(000 through 499).

<To end:>

END

Press **END**.

Conditions

- Each speed dial number has a maximum of 24 digits. The valid characters are **0 through 9, *, and # keys, and the FLASH, PAUSE, SECRET and "-"(hyphen) buttons.**
 - To store the flash signal, press **FLASH**.

Note: The Stored flash will only be effective during an established call.

 - To store a hyphen, press the "-" button.

-
- To store a pause, press **PAUSE**.
(Refer to Pulse to Tone Conversion in the Features Guide)
 - To store a feature number to convert pulse signals to DTMF (Dual Tone Multi-Frequency) signals, press the * and # keys. (Refer to Pulse to Tone Conversion in the Features Guide.)
 - To prevent displaying of all or part of the number, press **SECRET** before and after the secret number, or your entry will not be stored. (Refer to Secret Dialing in the Features Guide.)
 - If you are storing an external number, enter the line access code (default: 9, 81 through 88) before the number. When dialing, a pause is automatically inserted after the code.
 - If you are storing an account code, enter the account code before the line access code. (Refer to Account Code Entry in the Features Guide.)
 - It is possible to store a number consisting of 25 digits or more by storing it in two speed dial numbers. The line access code should be stored in the first speed dial number.
 - To access another speed dial number in step 3 through 6, press **SELECT** and start with step 3.
 - To display parts of the number which have scrolled off the display, press **▶** or **◀**.
 - Program [002] "System Speed Dialing Name Set" is used to name the speed dial numbers.

User Manual References

- 4.3.77 System Speed Dialing
- 4.5.8 KX-T7235 Display Features - Call Directory
- 4.5.11 KX-T7431 / KX-T7433 / KX-T7436 Display Features - Call Directory

3.2.3 [002] System Speed Dialing Name Set

Description

Assigns names to the system speed dial numbers assigned in program [001] "System Speed Dialing Number Set." The KX-T7431, KX-T7433, KX-T7235 and KX-T7436 show the stored name during System Speed Dialing.

Selection

- Speed dial number: **000 through 499**
- Name: **10 characters (max.)**

Default

All speed dial numbers — Not Stored

Programming

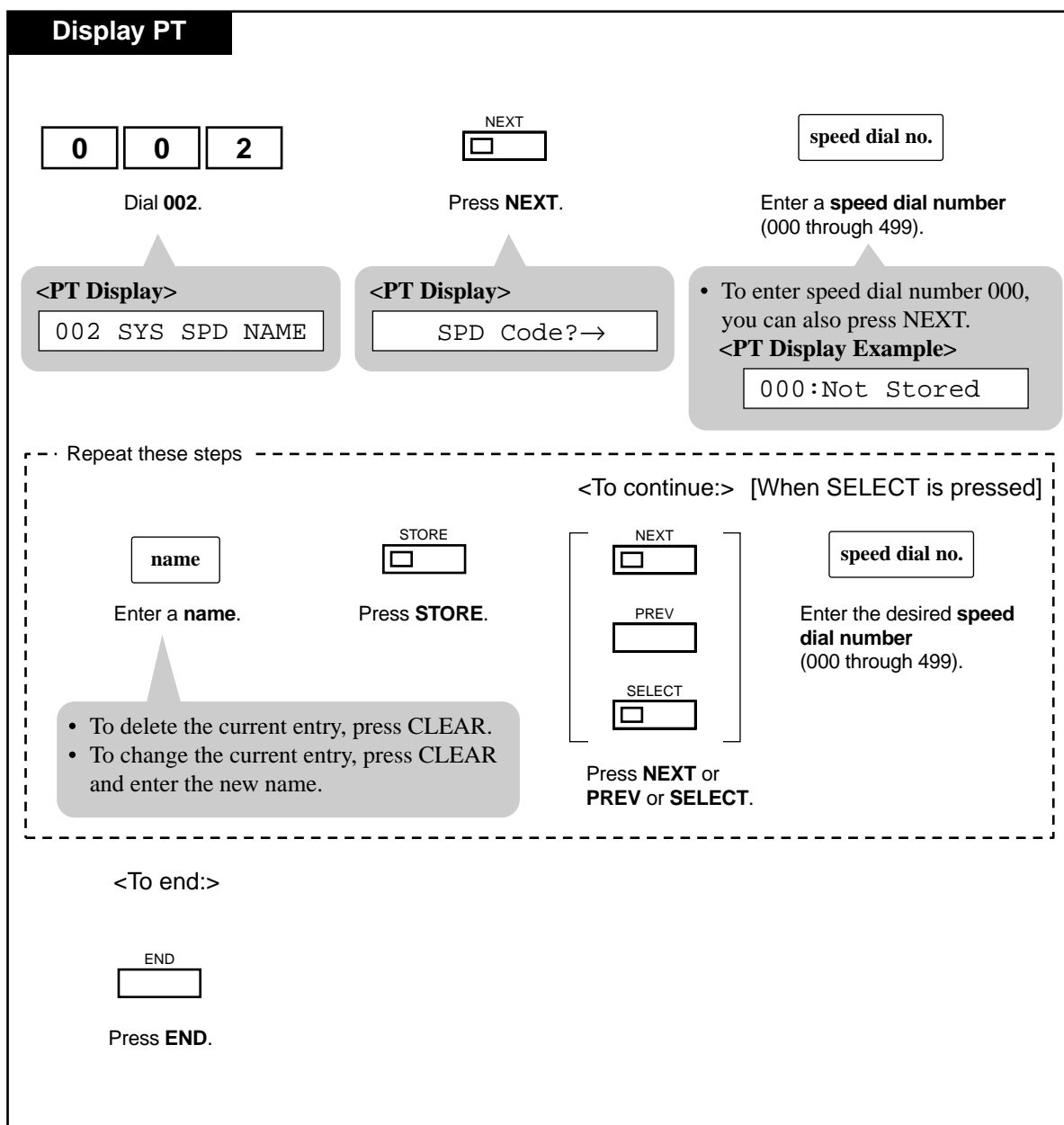

Conditions

- Speed dial numbers are programmed in program [001] "System Speed Dialing Number Set."
- Each name has a maximum of 10 characters.
- For entering characters, see 2.2.8 Station Speed Dialing Number/Name Assignment [KX-T7235/KX-T7431/KX-T7433/KX-T7436 only].

User Manual References

4.3.77 System Speed Dialing

4.5.8 KX-T7235 Display Features - Call Directory

4.5.11 KX-T7431 / KX-T7433 / KX-T7436 Display Features - Call Directory

3.2.4 [003] Extension Number Set

Description

Assigns an extension number to each extension.

Selection

- Jack number:
KX-TD816 - **01 through 16 (-1 / -2)**
KX-TD1232 - **01 through 64 (-1 / -2)**
(-1 = first part, -2 = second part)
- Extension Number: **2 through 4 digits**

Default

KX-TD816

Jack 01-1 through 16-1 = 101 through 116;

Jack 01-2 through 16-2 = 201 through 216

KX-TD1232

Jack 01-1 through 64-1 = 101 through 164;

Jack 01-2 through 64-2 = 201 through 264

Programming

Display PT

0
0
3

Dial **003**.

NEXT

Press **NEXT**.

jack no.

Enter a **jack number**.

<PT Display>

003 EXT NUMBER

<PT Display>

Jack NO?→

- To enter jack number 01, you can also press **NEXT**.
- To select the second part (-2), press **NEXT** after entering the jack number.

<PT Display Example>

#01-1:EXT101

Repeat these steps

extension no.

Enter the **extension no.**

STORE

Press **STORE**.

NEXT

PREV

SELECT

Press **NEXT** or **PREV** or **SELECT**.

jack no.

Enter the desired **jack number**.

<To end:>

END

Press **END**.

Conditions

- There is a maximum of 32 extension numbers for KX-TD816, and 128 extension numbers for KX-TD1232. Each extension number can be two, three, or four digits, consisting of **0 through 9**. The * and # keys cannot be used.
- For the KX-TD1232, jack numbers 01 through 32 are for the Master System and 33 through 64 are for the Slave, if available.
- An extension number is invalid if the first or second digits do not match with the program [100] "Flexible Numbering, (01)-(16) 1st through 16th hundred extension blocks" setting.

If one digit is assigned as the leading digit, some extensions have two digits and some have three digits. If two digits are assigned, some have three digits and some have four digits.

- Two extension numbers can be assigned per jack. If eXtra Device Port (XDP) is disabled for the jack in program [600] "EXtra Device Port" the extension number of the second part (XX-2) is not available. (XX=jack number)
- For an explanation of jack numbering, see "Rotation of jack number".
- A double entry or incompatible entry is invalid including the program [012] "ISDN Extension Number Set", [118] "Voice Mail Extension Number Assignment", [124] "Phantom Extension Number Assignment" and [813] "Floating Number Assignment". Valid entry examples are: 10 and 11; 10 and 110. Invalid entry examples are: 10 and 106; 210 and 21.
- Program [004] "Extension Name Set" is used to name the extension numbers.

User Manual References

4.3.49 Intercom Calling

4.5.8 KX-T7235 Display Features - Call Directory

4.5.11 KX-T7431 / KX-T7433 / KX-T7436 Display Features - Call Directory

3.2.5 [004] Extension Name Set

Description

Assigns names to the extension numbers programmed in program [003] Extension Number Set.

Selection

- Jack number:
KX-TD816 – **01 through 16 (-1 / -2)**
KX-TD1232 – **01 through 64 (-1 / -2)**
(-1 = first part, -2 = second part)
- Name: **10 characters (max.)**

Default

All extension ports — Not Stored

Programming

Display PT

0

0

4

NEXT

jack no.

Dial **004**.

Press **NEXT**.

Enter a **jack number**.

<PT Display>

004 EXT NAME SET

<PT Display>

Jack NO?→

- To enter jack number 01, you can also press **NEXT**.
- To select the second part (-2), press **NEXT** after entering the jack number.

<PT Display Example>

#01-1:Not Stored

Repeat these steps

name

STORE

NEXT

extension no.

Enter a **name**.

Press **STORE**.

PREV

Enter the **desired extension number**.

- To delete the current entry, press **CLEAR**.
- To change the current entry, press **CLEAR** and enter the new name.

NEXT

SELECT

Press **NEXT** or **PREV** or **SELECT**.

<To end:>

END

Press **END**.

Conditions

- There is a maximum of 32 names for KX-TD 816 and 128 names for KX-TD1232. Each name has a maximum of 10 characters.
- For entering characters, see Section 2.2.8 Station Speed Dialing Number/Name Assignment [KX-T7235/KX-T7431/KX-T7433/KX-T7436 only].
- Program [003] Extension Number Set is used to assign extension numbers.

User Manual

89

- For the KX-TD1232, Jack numbers 01 through 32 are for the Master System and 33 through 64 are for the Slave, if available.
- For an explanation of jack numbering, see "3.1.2 Programming Methods".

User Manual References

4.3.49 Intercom Calling

4.5.8 KX-T7235 Display Features - Call Directory

4.5.11 KX-T7431 / KX-T7433 / KX-T7436 Display Features - Call Directory

3.2.6 [017] DISA User Codes

Description

Assigns the Direct Inward System Access (DISA) User Codes and a Class of Service (COS) to each code. The code COS determines the toll restriction level of the DISA caller.

Warning

When you enable the Outside-Outside Line Call feature of DISA function, if a third party discovers the password (a DISA User Code) of the system, you have a risk that they will make illegal phone calls using your telephone line, and the cost may be charged to your account.

In order to avoid this problem, we strongly recommend the following points:

- 1: Carefully maintain the secrecy of the password.
- 2: Specify a complicated password as long and random as you can make it.
- 3: Change the password frequently.

Selection

- DISA user code number: **01 through 32**
- DISA user code: **4 through 10 digits**
- COS number: **1 through 8**

Default

All DISA user code numbers - DISA user code=Blank; COS number=8

Programming

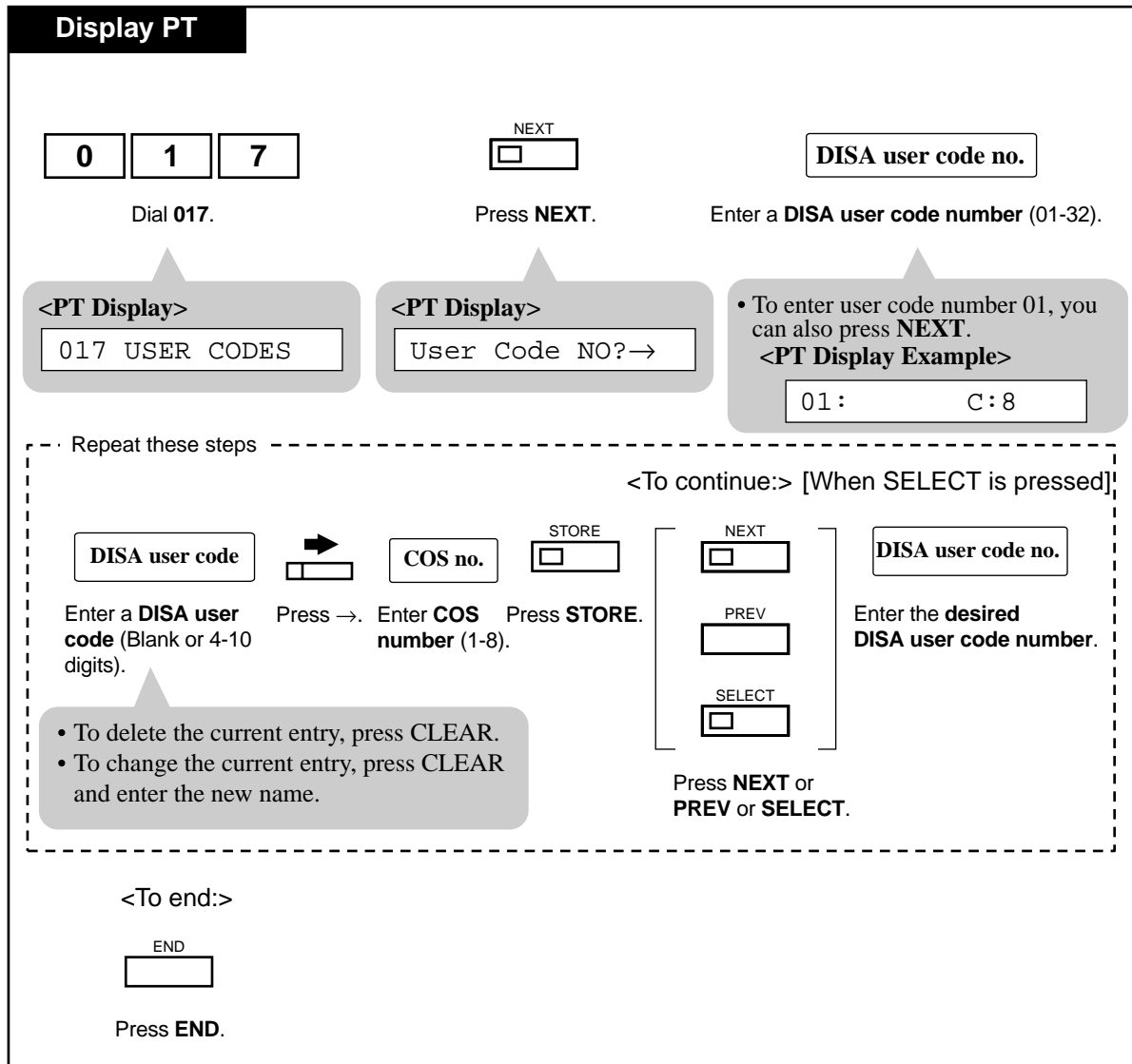

Section 4
Station Features and Operation (DPT/SLT)

4.1 Before Operating

4.1.1 Before Operating

What kind of telephone do you use?

In this manual, you will find your way to operate the feature depending on the telephone you use. Please use the proper operation for your telephone.

If you use a Panasonic proprietary telephone which has the special function button and/or the display, you will follow the operation with the button or display for easy access.

- If you use a Panasonic proprietary telephone which does not have the function button, you may change one of the unused buttons to another button. Refer to 2.2 Station Programming.
- A Panasonic proprietary telephone has the Light Emitting Diode (LED) button indicators, so you can see the line conditions by the lighting patterns.
- If "Idle Line Preference — Outgoing", "No Line Preference — Outgoing" or "Prime Line Preference (CO Line) — Outgoing" is assigned on the extension, it is **not** possible to have access to any DPT features after simply going off-hook. To access DPT features, press the INTERCOM button after going off-hook.

If you use single line devices such as a single line telephone or data terminal, you will follow the steps which enter the feature number.

- If you use a dial pulse (DP) type single line device which does not have the "*" and "#" keys, it is impossible to access features that have "*" or "#" in their feature numbers.
- When the "Pickup Dialing (Hot Line)" feature is set on your telephone, the dialing sequence should be done within a certain period of time (Pickup Dial Waiting Time — default: 1 s) after lifting the handset.
This time can be changed by System Programming.

If you use a ISDN telephone which are connected to the optional ISDN Line Unit, KX-TD284, can perform features in this section. However, there are some exceptions.

Operation Step Box

In this section, operations for extension users are described using the following Operation Step Box.

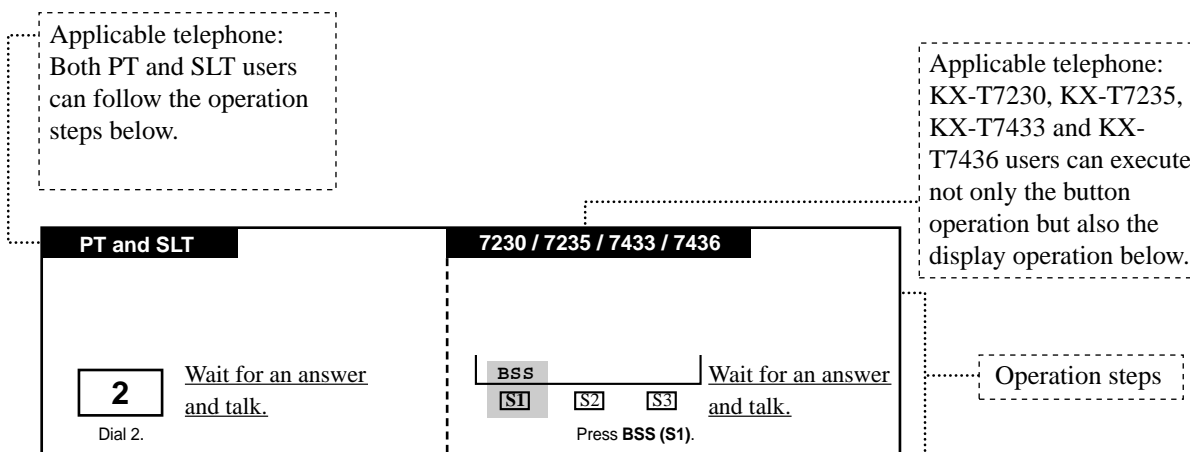

Note

- If your telephone is not noted in the operating step box (ex., only "PT" is noted), this means your telephone does not have the ability to execute that feature.
- If your telephone has the ability to perform several operations for one feature, you can select the method according to your needs.
- In this manual, the default feature numbers are used to describe each operation and illustration. Use the new programmed numbers if default feature numbers are changed by System Programming.
- For proprietary telephone operations, all button illustrations are based on the model KX-T7235.

Description of Symbols Used

In this section, many symbols are used. Most symbols do not need a description, but some symbols do. They are as follows.



Lift the handset, or press the SP-PHONE or MONITOR button. (Off-hook)



Replace the handset, or press the SP-PHONE or MONITOR button. (On-hook)



Flash the hookswitch on a single line telephone.



Tones which vary depending on the condition (Refer to 6.1.3 Tone List).

4.2 Basic Operations

4.2.1 Making Calls

Intercom Calling

You can make a call to another extension.

Any Telephone



Lift the handset or press
SP-PHONE/MONITOR.

extension no.

 or

(DSS)



Talk.



Hang up or press
SP-PHONE/MONITOR.

Dial extension number. Press **DSS**.

- The INTERCOM indicator light turns green.

Outward Dialing

You can make a call to an outside party using one of the following line access methods.

- a) Line Access, Automatic (default: 9)
- b) Line Access, Individual (CO button)
- c) Line Access, Outside Line Group (default: 81 through 88)

Any Telephone



Lift the handset or press
SP-PHONE/MONITOR.

(CO)

 For PT

line access code

 For any
telephone



Dial tone

phone no.



Talk.

For PT: Press **CO** assigned as Loop-CO / Group-CO / Single-CO.
For any telephone: Dial the line access code (9 or 81 through 88).

Hang up or press
SP-PHONE/MONITOR.

The selected CO indicator light turns green.

- The display shows the phone number.

Conditions



<PT>

- There are four types of Line Preference for outgoing calls (— Idle Line/No Line/Prime Line/Prime INTERCOM Line). Each preference can be selected by Station or System Programming.
- With the KX-T7431, KX-T7433, KX-T7436 or KX-T7235, you can execute the "Intercom Calling" feature to extensions by using the "Extension Dialing" display feature.
- Helpful hints for the Handsfree (speakerphone) operation are noted in the "Handsfree Operation" feature.

User Manual References

- 2.2.1 Initial Settings
- 4.3.48 Hands-free Operation [PT only]
- 4.3.49 Intercom Calling
- 4.3.61 Outward Dialing, Line Access — SUMMARY
- 4.5.8 KX-T7235 Display Features - Call Directory
- 4.5.11 KX-T7431 / KX-T7433 / KX-T7436 Display Features - Call Directory

4.2.2 Receiving Calls

Any Telephone	PT
 <p>Lift the handset or press SP-PHONE /MONITOR.</p>	<div style="text-align: center;">  (CO) or  INTERCOM </div> <p>Press a rapid flashing CO or INTERCOM.</p> <div style="border: 1px solid gray; border-radius: 10px; padding: 5px; background-color: #f0f0f0;"> <ul style="list-style-type: none"> • The CO or INTERCOM indicator light turns steady green. </div>

Conditions

<PT>

- There are three types of Line Preference for incoming calls (— No Line/Prime Outside Line/Ringing Line). Each preference can be selected by Station Programming.
- Helpful hints for the Handsfree (speakerphone) operation are noted in the "Handsfree Operation" feature.

Programming Guide References

[400] Outside Line Connection Assignment

[603-604] DIL 1:N Extension and Delayed Ringing — Day / Night

User Manual References

2.2.1 Initial Settings

4.3.4 Answering, Direct Outside Line [PT only]

4.3.48 Hands-free Operation [PT only]

4.3 Station Features and Operation

4.3.1 Absent Message Capability

You can select one of nine pre-programmed Absent Messages (1-9) for your extension. The display PT users calling your extension see the message you select. Absent messages are used to inform the party calling to your extension of the reason for your absence. By default, Messages No. 1-6 are provided with default messages and the other three messages are left blank.

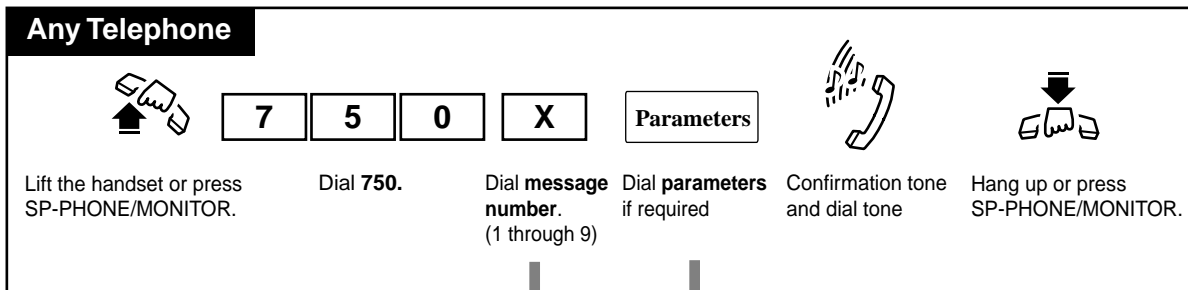

DISPLAY MESSAGE	MESSAGE NO.	PARAMETER
Will Return Soon	<input type="text" value="1"/>	None
Gone Home	<input type="text" value="2"/>	None
At Ext % % %	<input type="text" value="3"/>	<input type="text" value="extension no."/> Dial extension number.
Back at % % : % % (<i>time</i>)	<input type="text" value="4"/>	<input type="text" value="hour"/> <input type="text" value="minute"/> Enter hour (00 through 23) and minute (00 through 59).
Out Until % % / % % (<i>month/day</i>)	<input type="text" value="5"/>	<input type="text" value="month"/> <input type="text" value="day"/> Enter month (01 through 12) and day (01 through 31).
In a Meeting	<input type="text" value="6"/>	None
(Programmable)	<input type="text" value="7"/>	
(Programmable)	<input type="text" value="8"/>	
(Programmable)	<input type="text" value="9"/>	

Note

Enter the desired value in the "%" space. You must make an entry in all of the %s using 0 through 9, "#" or "*".

Canceling the absent message

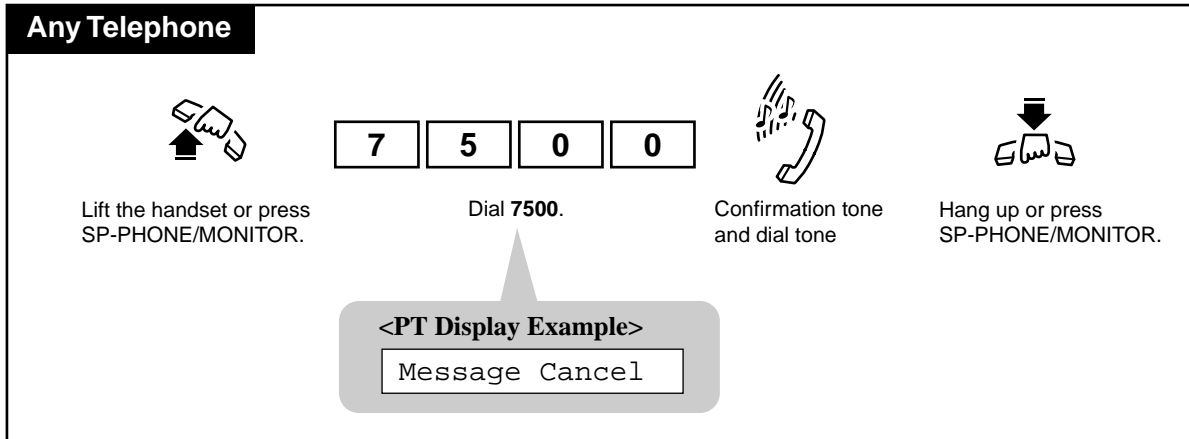

Conditions

- All nine messages can be programmed either by User or System Programming.

<display PT>

- The message you select is shown on the display of your PT whenever you go off-hook.
- Regarding Message 3;
 - a) If the extension number you want to enter has more than the number of "%" characters, refer to System Programming to change the setting.
 - b) If the extension number you want to enter has less than the number of "%" characters, fill the remaining "%" characters with "#" or "*".
- With the KX-T7431, KX-T7433, KX-T7436 or KX-T7235, you can execute this feature using the display operation.

Programming Guide References

[008] Absent Messages

User Manual References

4.5.9 KX-T7235 Display Features - System Feature Access Menu

4.5.12 KX-T7431 / KX-T7433 / KX-T7436 Display Features - System Feature Access Menu

4.3.2 Account Code Entry

An Account Code is used to identify outside calls for accounting and billing purposes. The account code is appended to the "Station Message Detail Recording (SMDR)" call record. For incoming outside calls, account code are not required. For outgoing outside calls, you may be required to enter an account code.

Your Account Code Entry mode is set to one of the following three modes by System Programming.

In "Verified - All Calls" mode

- You must always enter a system-registered account code to make an outside call.

In "Verified - Toll Restriction Override" mode

- You can override the Toll Restriction imposed on your extension by entering a system-registered account code before making an outside call (Toll Restriction Override by Account Code Entry).

In "Option" mode

- You may enter any account code.

One mode is selected for each extension on a "Class of Service^{*1}" basis.

^{*1} Class of Service (COS) is used to define the features which are allowed for a group of extensions. For more details, please consult with your dealer.

Entering account codes before dialing

7230 / 7235 / 7433 / 7436

Off-hook. Press **ACCNT (S3)**. Dial tone 3* Enter an **account code** (10 digits max., 0...9). Dial #. Confirmation tone and dial tone

<PT Display Example>
Enter ACCNT Code

- You may dial 99 instead of "#".

CO phone no.

Press **CO**. Dial the **phone number**.

*One of the dial tones. Refer to the "Tone List" in the Appendix.

Any Telephone

Lift the handset or press SP-PHONE/MONITOR. For PT: Press **Account** (flexible button). For any telephone: Dial **49**. Dial tone 3* Enter an **account code** (10 digits max., 0...9). Dial #.

- If you dial a feature number, you hear no tone.
- You may dial 99 instead of "#".

Confirmation tone and dial tone Press **CO** or enter a **line access code** (9 or 81 through 88). Dial the **phone number**.

*One of the dial tones. Refer to the "Tone List" in the Appendix.

Entering account codes during or after a conversation

During a conversation or within 15 seconds after the other party hangs up;

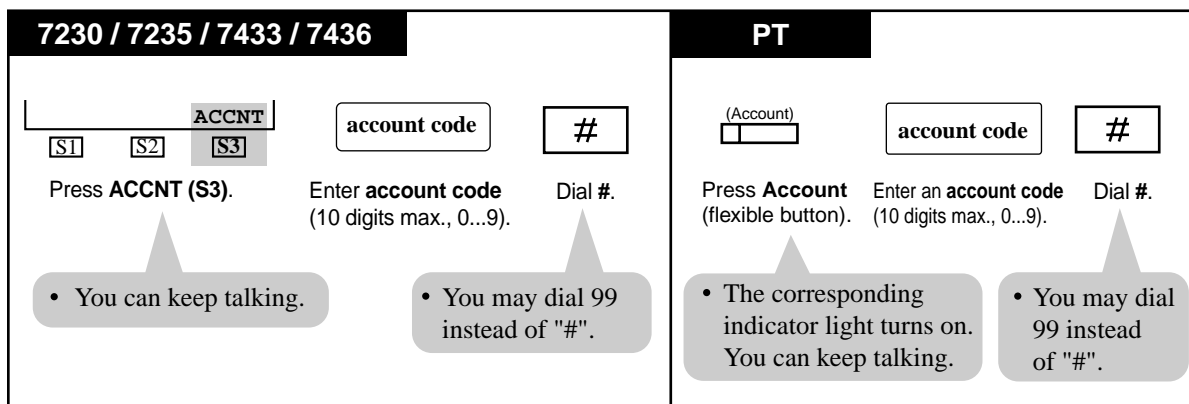

Conditions

- In Verified - All Calls mode, you must always enter a pre-assigned account code when making any of the following calls.
 - a) Call Forwarding — to Outside Line
 - b) Manual Dialing (Selecting an outside line)
 - c) One-Touch Dialing
 - d) Pickup Dialing (Hot Line)
 - e) Station Speed Dialing
 - f) System Speed Dialing
- If you use Last Number Redial or Saved Number Redial, you do not have to re-enter the Account Code.
- In Option mode, it is possible to record a calling or called party's account code in the SMDR, during a conversation or within fifteen seconds after the other party hangs up.
- There is no need for an account code entry when receiving incoming calls.
- To clear and re-enter the account code, press "*".
- An account code can be up to 10 numeric digits (0 through 9). FLASH, PAUSE, etc. are not allowed. After entering an account code, the delimiter "#" or "99" must be entered.
- **Memory Dialing**
 An account code can be stored into Memory Dialing ("One-Touch Dialing", "System / Station Speed Dialing"). The sequence to enter an account code into Memory Dialing is:
 — [Feature Number] [Account Code] [#] [Line Access Code] [Phone Number]
 or
 — [Feature Number] [Account Code] [99] [Line Access Code] [Phone Number]

<PT>

- Pressing the Account button (flexible button) while entering an account code cancels the entry.
- If an entered account code does not match the pre-assigned account code, in the verified-all calls mode or the verified-toll restriction override mode;
 - a) When making an outside call, a reorder tone is returned.
 - b) During a conversation, the code entry is accepted and the call is maintained (= Option mode).
 - c) After a CPC signal^{*1} has been detected, the code entry is accepted (= Option mode).
- **Account button**
The Account button can be used instead of dialing the feature number. It can be assigned to a flexible (CO, DSS, PF) button by Station, User or System Programming.

<SLT>

- You cannot enter an account code during a call or while hearing a reorder tone.
- Flashing the hookswitch while entering an account code cancels the entry.

Programming Guide References

- [105] Account Codes
- [508] Account Code Entry Mode
- [601] Class of Service

Features Guide References

- Station Message Detail Recording (SMDR)

User Manual References

- 2.2.2 Flexible Button Assignment
- 4.3.80 Toll Restriction Override by Account Code Entry

^{*1} A Calling Party Control (CPC) signal is an on-hook indication sent from a CO line when the other end hangs up. You hear a reorder tone when then signal is detected.

4.3.3 Alternate Calling — Ring / Voice

You can voice-announce your intercom call or have the called extension ring. When you make an intercom call by voice-announcement, the other party hears your voice over the built-in speaker of PT and can speak in the hands-free mode.

Alternating (to Voice-Calling mode)

7230 / 7235 / 7433 / 7436

If the extension you are calling is in Ring-Calling mode, you hear a ringback tone.

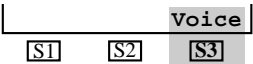

Press **Voice (S3)**.



Confirmation tone

- Voice-Calling mode is established.

Any Telephone

If the extension you are calling is in Ring-Calling mode, you hear a ringback mode.



Dial *.



Confirmation tone

- Voice-Calling mode is established.

Alternating (to Ring-Calling mode)

7230 / 7235 / 7433 / 7436

If the extension you are calling is in Voice-Calling mode, you hear a confirmation tone.

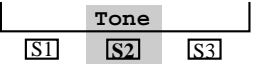

Press **Tone (S2)**.



Ringback tone

- Ring-Calling mode is established.

Alternating (to Ring-Calling mode)

Any Telephone

If the extension you are calling is in Voice-Calling mode, you hear a confirmation.



Dial *.



Ringback tone

- Ring-Calling mode is established.

Conditions

- **Voice-signaling is not available in the following cases:**
 - if the other extension is an SLT.
 - if the other extension is busy on another call.
 - if another call is ringing on the other extension.
- **One time switching**
You can switch the desired calling mode only once during a call.
- If the party you are calling is using a single line telephone (SLT), only Ring-Calling mode is available.

<PT>

- **Mode Selection**
You can select either to be ring-signaled or voice-signaled by Station Programming (Intercom Alert Assignment).
The default is Ring-Calling mode.

User Manual References

- 2.2.1 Initial Settings
- 4.3.47 Hands-free Answerback [PT only]
- 4.3.49 Intercom Calling

4.3.4 Answering, Direct Outside Line [PT only]

You can answer an outside call by pressing a flashing a CO button directly. You do not have to lift the handset or press the SP-PHONE/MONITOR button.

To answer an incoming outside call

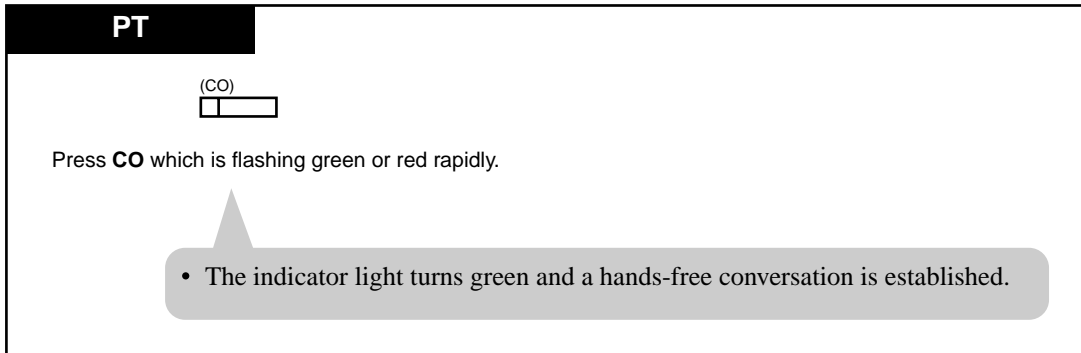

Conditions

- You can choose the desired line to answer when more than one call is ringing on your PT by this feature.
- There are three types of CO buttons: Group-CO (G-CO) button, Loop-CO (L-CO) button and Single-CO (S-CO) button. These can be assigned to flexible CO buttons by Station, User or System Programming.

User Manual References

- 2.2.1 Initial Settings
- 2.2.2 Flexible Button Assignment
- 4.3.48 Hands-free Operation [PT only]

4.3.5 Automatic Callback Busy (Camp-On)

Allows you to set to receive callback ringing when the dialed line becomes idle. When you answer the callback ringing;

For an extension: The called extension starts ringing without dialing.

For an outside line: The line is seized.

Setting

7230 / 7235 / 7433 / 7436

If you hear a busy tone after making a call (intercom or outside);

Press **C. BCK (S3)**. Confirmation tone and reorder tone Hang up or press SP-PHONE.

Wait for the Camp-On recall.

PT and SLT

If you hear a busy tone after making a call (intercom or outside);

Dial **6**. Confirmation tone and reorder tone Hang up or press SP-PHONE/MONITOR.

Wait for the Camp-On recall.

<PT Display Example>
 Callback Extxxxx
 — extension number

Answering an intercom recall

PT and SLT

If you hear the telephone ringing;



Lift the handset or press SP-PHONE/MONITOR.

<PT Display Example>

xxxx: Free

extension number

- You hear a ringback tone and the other extension begins to ring automatically.

Answering an outside line recall

PT and SLT

If you hear the telephone ringing;



Lift the handset or press SP-PHONE/MONITOR.



Dial tone

phone no.

Dial the **phone number**.

<PT Display Example>

COXX: Free

outside line number

Canceling

PT and SLT



Lift the handset or press SP-PHONE/MONITOR.

4 6

Dial **46**.



Confirmation tone and dial tone



Hang up or press SP-PHONE/MONITOR.

Conditions

- If you do not answer the recall ringing within 10 seconds (four callback ring signals), this feature will be automatically canceled.
- If the called party becomes busy again after the callback ringing starts, the ringing stops but this feature will be executed again when the extension becomes free.
- With the KX-T7431, KX-T7433, KX-T7436 or KX-T7235, you can set and cancel this feature using the display operation.

<ISDN Telephone>

- This feature is not available for ISDN telephones.

User Manual References

4.5.9 KX-T7235 Display Features - System Feature Access Menu

4.5.12 KX-T7431 / KX-T7433 / KX-T7436 Display Features - System Feature Access Menu

4.3.6 Background Music (BGM) [PT only]

You can hear background music through the built-in speaker of your PT. An external music source, such as a radio, must be connected. The music stops whenever a call comes in or when you go off-hook.

Setting / Canceling

7230 / 7235 / 7433 / 7436

When the handset is on the cradle and the SP-PHONE button is off;

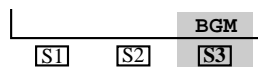

Press **BGM (S3)**.

- To turn off the BGM, press this button again.

PT

When the handset is on the cradle and the SP-PHONE/MONITOR button is off;

1

Dial 1.

- The display shows either one of the following for five seconds depending on whether BGM is on or off:

<PT Display Example>

BGM On

or

BGM Off

Conditions

- **Turning on/off**
You can turn on/off the BGM only when your PT is not in use.

Programming Guide References

[803] Music Source Use

[990] System Additional Information

4.3.7 Busy Station Signaling (BSS)

You can prompt a busy extension (ringing or during a call) to answer your call. The other extension hears three beeps and knows that you are waiting.

7230 / 7235 / 7433/ 7436

If you hear a busy tone after making an intercom call;

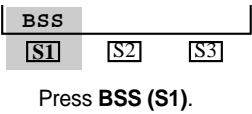

Press **BSS (S1)**.



Wait for an answer and talk.

PT and SLT

If you hear a busy tone after making an intercom call;

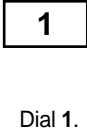

Dial **1**.



Wait for an answer and talk.

Conditions

- **BSS / OHCA / Whisper OHCA**
 If an extension user dials "1" while hearing a busy tone, BSS or OHCA or Whisper OHCA may be activated at the called extension.
 This is determined by the following conditions.

Calling extension COS-OHCA assignment	Called extension			
	Call Waiting setting			
	OFF	ON		
	0	1	2	3
Disable	—	BSS	BSS	BSS
Enable	—	BSS	OHCA*1 → BSS	W-OHCA*2 → OHCA → BSS

*1 OHCA (Off-Hook Call Announcement) is activated when the called extension is KX-T7235 or KX-T7436.

*2 Whisper OHCA is activated when both calling and called extensions are using one of the KX-T7400 series PT.

- To answer the signal from the calling extension, see 4.3.27 Call Waiting.
- If "BSS" is not displayed or you hear a reorder tone when you set this feature, this feature will not be set at the called party. This feature is only available if the called extension has set the "Call Waiting" feature.
- Only the extensions which have enabled "Call Waiting" can receive Call Waiting tones.
- Depending on the party's telephone, the "Off-Hook Call Announcement (OHCA)" or "Whisper OHCA" function can be applied. You can talk to the party through the speaker and the microphone while the party is having another conversation using the handset.

<ISDN Telephone>

- This feature is not available for ISDN telephones.

User Manual References

4.3.27 Call Waiting

4.3.56 Off-Hook Call Announcement (OHCA)

4.3.57 Off-Hook Call Announcement (OHCA) —Whisper [PT only]

4.3.8 Call Forwarding — SUMMARY

Automatically transfers incoming calls to another extension or to an external destination. The following types are available:

Type	Description
Call Forwarding — All Calls	All incoming calls are forwarded to another extension.
Call Forwarding — Busy	All incoming calls are forwarded to another extension when your extension is busy.
Call Forwarding — No Answer	All incoming calls are forwarded to another extension when you do not answer the call.
Call Forwarding — Busy/No Answer	All incoming calls are forwarded to another extension when you do not answer or when your extension is busy.
Call Forwarding — to Outside Line	All incoming calls are forwarded to an outside line.
Call Forwarding — Follow Me	Allows you to set the "Call Forwarding — All Calls" feature from another extension.

Note

You can also set Voice Mail as the forwarding destination. Refer to 4.3.85 Voice Mail Integration.

Conditions

- To cancel Call Forwarding features, refer to 4.3.15 Call Forwarding — CANCEL.
- Forwarded call is not forwarded furthermore**
Call Forwarding can only be extended to one target telephone. For example, extension A is forwarded to extension B, and extension B is forwarded to extension C. A call to extension A is forwarded to extension B, but the call would not be forwarded to extension C. Consequently, extension B is treated as the final destination of Call Forwarding.

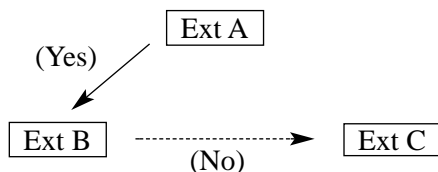

- Setting a new "Call Forwarding" function (All Calls, Busy, Busy/No Answer, etc.) cancels any other "Call Forwarding" functions.
- Floating Station**
A floating station such as a DISA (Direct Inward System Access), MODEM or external pager cannot be programmed as a forwarding destination.

- Two extensions can set each other as the destination extension. In this case, an intercom call to the other party while he/she is absent will not be forwarded back to the original extension.
- **Confirmation tone**
Confirmation tone 2 (two beeps) is sent when the previously programmed data is same as the new data. If it is not, confirmation tone 1 (one beep) is sent. Refer to the "Tone List" in the Appendix.
- You can call the original extension from the Call Forwarding destination extension. (Boss Secretary)

<PT>

- Both the Call Forwarding and Do Not Disturb (DND) functions can be programmed at the same time, but either one of them can be activated at a time.
- You can enable or disable the Call Forwarding or Do Not Disturb (DND) function by pressing the FWD/DND button while on-hook. If you set both Call Forwarding and DND, alternating the mode is also available by pressing the FWD/DND button. In this case, pressing the button changes the setting as follows:

→DND →FWD →OFF

The lighting patterns of the FWD/DND button are as follows:

Off: Both functions are canceled.

Red on : DND mode*¹

Red flash : FWD mode*¹

- With the KX-T7436 and KX-T7235, you can set or cancel the Call Forwarding features using the display operation.

<7250>

- **FWD/DND button**

A flexible button on the KX-T7250 (no FWD/DND button provided) can be assigned to a flexible (CO, DSS, PF) button by Station, User or System Programming.

<ISDN Telephone>

- This feature is not available for ISDN telephones.

User Manual References

- 2.2.2 Flexible Button Assignment
- 4.3.15 Call Forwarding — CANCEL
- 4.3.35 Do Not Disturb (DND)
- 4.3.85 Voice Mail Integration
- 4.5.2 Call Forwarding / Do Not Disturb (KX-T7436 / KX-T7235 only)

*¹ This setting can be changed by System Programming.

4.3.9 Call Forwarding — All Calls

All of calls coming to your extension are forwarded to the pre-assigned extension automatically.

Setting

7235 / 7436



Lift the handset or press SP-PHONE.



Press **FWD/DND**.

F3
FWD-All Calls(→ext)

F4

F5

Press **FWD-All Calls (F3)**.

extension no.

Enter the destination **extension number**.



Confirmation tone and dial tone



Hang up or press SP-PHONE.

<PT Display Example>

FWD(All) Extxxxxx

extension number where the call is to be forwarded

- The FWD/DND indicator light flashes red slowly.

PT and SLT



Lift the handset or press SP-PHONE/MONITOR.



For PT: Press **FWD/DND**.
For PT, SLT: Dial **710**.

7
1
0

For PT, SLT

2

Dial **2**.

extension no.

Enter the destination **extension number**.



Confirmation tone and dial tone



Hang up or press SP-PHONE/MONITOR.

<PT Display Example>

FWD(All) Extxxxxx

extension number where the call is to be forwarded

- The FWD/DND indicator light flashes red slowly.

You may press the flexible button assigned as the FWD/DND button instead.

4.3.10 Call Forwarding — Busy

You can forward calls to another extension when your extension is busy.

Setting

7235 / 7436



Lift the handset or press SP-PHONE.



Press **FWD/DND**.

F4

 FWD-Busy (→ext)

F5

extension no.



Confirmation tone and dial tone



Hang up or press SP-PHONE.

<PT Display Example>

FWD(BSY) Extxxxx

extension number where the call is to be forwarded

- The FWD/DND indicator light flashes red slowly.

PT and SLT



Lift the handset or press SP-PHONE/MONITOR.

FWD/DND

7

1

0

For PT: Press **FWD/DND**.
For PT, SLT: Dial **710**.

3

Dial **3**.

extension no.



Confirmation tone and dial tone



Hang up or press SP-PHONE/MONITOR.

- You may press the flexible button assigned as the FWD/DND button instead.

<PT Display Example>

FWD(BSY) Extxxxx

extension number where the call is to be forwarded

- The FWD/DND indicator light flashes red slowly.

4.3.11 Call Forwarding — No Answer

Your calls are forwarded to another extension when you do not answer the call within a pre-determined time.

Setting

7235 / 7436



Lift the handset or press SP-PHONE.



Press **FWD/DND**.



Press **FWD-No Answer (F5)**.

extension no.

Enter the destination **extension number**.



Confirmation tone and dial tone

<PT Display Example>

FWD (NA) Extxxxx

extension number where the call is to be forwarded

- The FWD/DND indicator light flashes red slowly.



Hang up or press SP-PHONE.

PT and SLT



Lift the handset or press SP-PHONE/MONITOR.



For PT: Press **FWD/DND**.
For PT, SLT: Dial **710**.

7 1 0

For PT, SLT

4

Dial **4**.

extension no.

Enter the destination **extension number**.



Confirmation tone and dial tone

- You may press the flexible button assigned as the FWD/DND button instead.

<PT Display Example>

FWD (NA) Extxxxx

extension number where the call is to be forwarded

- The FWD/DND indicator light flashes red slowly.



Hang up or press SP-PHONE/MONITOR.

Conditions

- The number of rings before a call is forwarded can be changed for each extension (except ISDN extensions / T1 extensions) with program "[619] Extension Call Forwarding — No Answer Time." If "[619] Extension Call Forwarding — No Answer Time" is not set, program "[202] Call Forwarding — No Answer Time" will be used.

Programming Guide References

[202] Call Forwarding — No Answer Time

[619] Extension Call Forwarding — No Answer Time

4.3.12 Call Forwarding — Busy / No Answer

You can forward your calls to another extension when your extension is busy or you do not answer the call within a pre-determined time.

Setting

7235 / 7436



Lift the handset or press SP-PHONE.



Press **FWD/DND**.

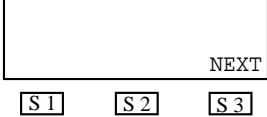

Press **NEXT (S3)**.

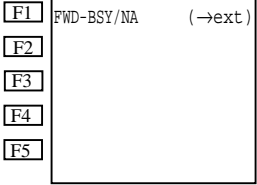

Press **FWD-BSY/NA (F1)**.

extension no.

Enter the destination **extension number**.



Confirmation tone and dial tone



Hang up or press SP-PHONE.

<PT Display Example>

FWD (B/NA) Extxxxx

— extension number where the call is to be forwarded

- The FWD/DND indicator light flashes red slowly.

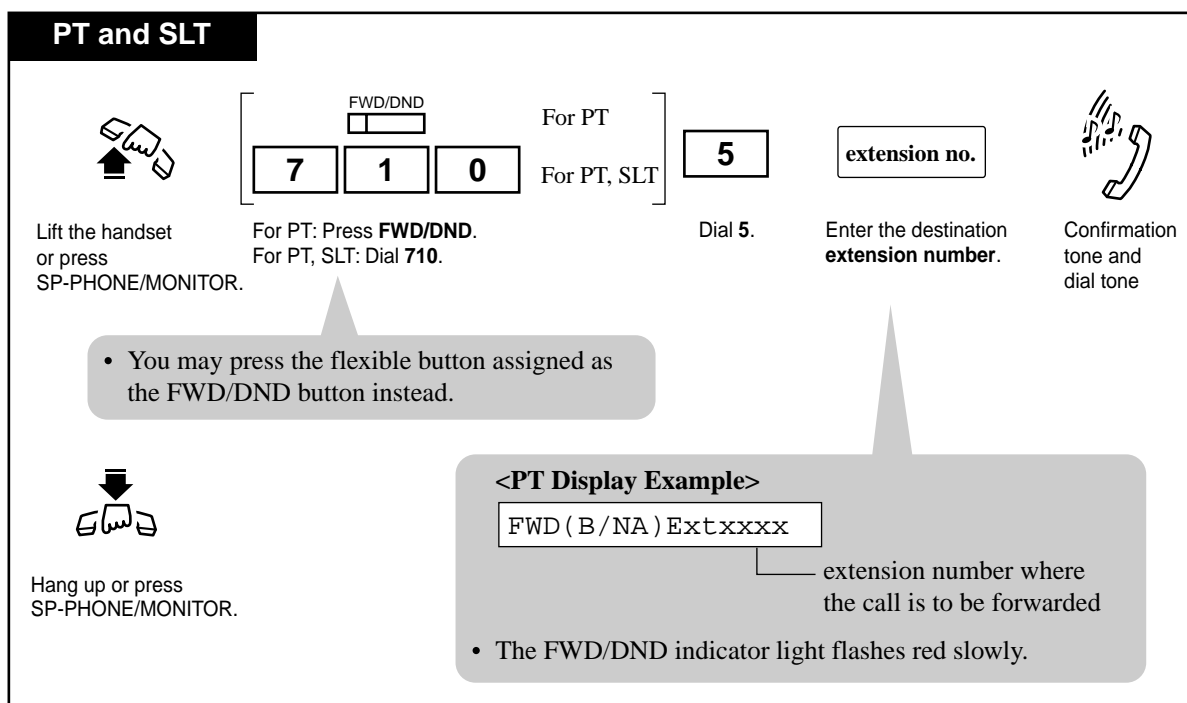

Conditions

- The number of rings before a call is forwarded can be changed for each extension (except ISDN extensions / T1 extensions) with program "[619] Extension Call Forwarding — No Answer Time". If "[619] Extension Call Forwarding — No Answer Time" is not set, program "[202] Call Forwarding — No Answer Time" will be used.

Programming Guide References

[202] Call Forwarding — No Answer Time

[619] Extension Call Forwarding — No Answer Time

4.3.13 Call Forwarding — to Outside Line

You can forward all incoming calls to your extension to an outside party via a CO or TIE line. The telephone number of the outside party must be pre-programmed.

7235 / 7436



Lift the handset or press SP-PHONE.



Press **FWD/DND**.

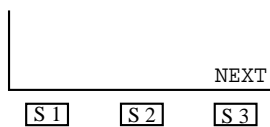

Press **NEXT (S3)**.

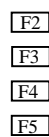

Press **FWD-CO Line (F2)**.

line access code

Enter a **line access code** (9 or 81 through 88).

phone no.

Dial the **phone number**.

#

Dial **#**.



Confirmation tone and dial tone



Hang up or press SP-PHONE.

<PT Display Example>

- When you dial "1234567"

FWD (CO) 91234567

- The FWD/DND indicator light flashes red slowly.

PT and SLT



Lift the handset or press SP-PHONE/MONITOR.



For PT: Press **FWD/DND**.
For PT, SLT: Dial **710**.

6

Dial **6**.

line access code

Enter a **line access code** (9 or 81 through 88).

phone no.

Dial the **phone number**.

#

Dial **#**.

<PT Display Example>

- When you dial "1234567":

FWD (CO) 91234567

- The FWD/DND indicator light flashes red slowly.

Conditions

- Up to 16 digits (including a line access code) can be programmed.
- Valid digits are "0 through 9" and "*". PAUSE (pausing time) can be stored by dialing **.
- **Class of Service**
Class of Service programming determines the extensions that can perform this feature.
- **Outside-to-Outside Line Call**
If an incoming outside call is forwarded to an outside line, the "Outside-to-Outside Line Call Duration Time" is applied to the call and the line will be disconnected when it expires (default: 10 min).

Programming Guide References

- [206] Outside-to-Outside Line Call Duration Time
- [504] Call Forwarding to Outside Line
- [601] Class of Service

4.3.14 Call Forwarding — Follow Me

You can set the "Call Forwarding" feature from the destination extension. This is useful if you forget to set "Call Forwarding — All Calls" before you leave your desk.

Setting

7235 / 7436

At the destination extension;



Lift the handset or press SP-PHONE.



Press **FWD/DND**.

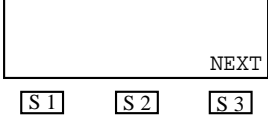

Press **NEXT (S3)**.

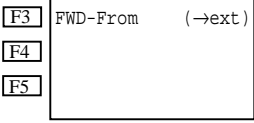

Press **FWD-From (F3)**.

your extension no.

Dial your **extension number**.



Confirmation tone and dial tone



Hang up or press SP-PHONE.

<PT Display Example>

FWD (From) Extxxxx

└─ your extension number

- The FWD/DND indicator light flashes red slowly at your extension.

PT and SLT

At the destination extension;



Lift the handset
or press
SP-PHONE/MONITOR.

FWD/DND	
7	1 0

For PT: Press **FWD/DND**.
For PT, SLT: Dial **710**.

For PT

7

For PT, SLT

Dial 7.

your extension no.

Dial your
extension number.



Confirmation
tone and
dial tone

- You may press the flexible button assigned as the FWD/DND button instead.

<PT Display Example>

FWD (From) Extxxxx

— your extension number

- The FWD/DND indicator light flashes red slowly at your extension.



Hang up or press
SP-PHONE/MONITOR.

Conditions

- This feature can be canceled either at your own extension or at the destination extension.
- Class of service**
Class of service programming determines the extensions that can perform this feature.

Programming Guide References

[991] COS Additional Information

4.3.15 Call Forwarding — CANCEL

There are two canceling methods for "Call Forwarding". The canceling method depends on the Call Forwarding type that is assigned.

Canceling Call Forwarding at your (original) extension

7235 / 7436



Lift the handset or press SP-PHONE.



Press **FWD/DND**.

F1	FWD/DND Cancel
F2	
F3	
F4	
F5	

Press **FWD/DND Cancel (F1)**.



Confirmation tone and dial tone



Hang up or press SP-PHONE.

<PT Display Example>

FWD/DND Cancel

- The FWD/DND indicator light turns off.

PT and SLT



Lift the handset or press SP-PHONE/MONITOR.

FWD/DND		
7	1	0

For PT: Press **FWD/DND**.
For PT, SLT: Dial **710**.

0

Dial **0**.



Confirmation tone and dial tone



Hang up or press SP-PHONE/MONITOR.

- You may press the flexible button assigned as the FWD/DND button instead.

<PT Display Example>

FWD/DND Cancel

- The FWD/DND indicator light turns off.

Canceling Call Forwarding at the destination extension — "Follow Me (All Calls)" only

7235 / 7436

Lift the handset or press SP-PHONE.

Press **FWD/DND**.

Press **NEXT (S3)**.

Press **FWD-From Cancel (F4)**.

Dial your **extension number**.

Confirmation tone and dial tone

Hang up or press SP-PHONE.

<PT Display Example>
 FWD Cancel Exxxx
 your extension number.

- The FWD/DND indicator light on your own extension turns off.

PT and SLT

Lift the handset or press SP-PHONE/MONITOR.

For PT: Press **FWD/DND**.
 For PT, SLT: Dial **710**.

For PT
 For PT, SLT

Dial **8**.

Dial your **extension number**.

Confirmation tone and dial tone

Hang up or press SP-PHONE/MONITOR.

<PT Display Example>
 FWD Cancel EXXXX
 your extension number.





- The FWD/DND indicator light on your own extension turns off.

You may press the flexible button assigned as the FWD/DND button instead.

4.3.16 Call Hold

Allows you to place an intercom or outside call on hold. While the call is on hold, you can make and receive other calls.

To place a call on hold

PT	SLT		
<p><i>During a conversation;</i></p> <div style="text-align: center;">  </div> <p>Press HOLD.</p> <div style="text-align: center;">  </div> <p>Confirmation tone and dial tone</p> <div style="border: 1px solid gray; padding: 5px; margin-top: 10px;"> <ul style="list-style-type: none"> You may replace the handset. </div> <div style="border: 1px solid gray; padding: 5px; margin-top: 10px;"> <ul style="list-style-type: none"> The corresponding CO or INTERCOM indicator light flashes green slowly. </div>	<p><i>During a conversation;</i></p> <div style="text-align: center;">  </div> <p>Flash the hookswitch.</p> <div style="text-align: center;"> <table border="1" style="display: inline-table; margin-right: 10px;"> <tr><td style="padding: 5px;">5</td></tr> </table> <table border="1" style="display: inline-table;"> <tr><td style="padding: 5px;">0</td></tr> </table> </div> <p>Dial 50.</p> <div style="text-align: center;">  </div> <p>Confirmation tone and dial tone</p> <div style="border: 1px solid gray; padding: 5px; margin-top: 10px;"> <ul style="list-style-type: none"> You may replace the handset. </div>	5	0
5			
0			

Retrieving a call on hold

PT	SLT						
<p><i>At the holding extension;</i></p> <div style="text-align: center;"> <table style="display: inline-table; border: 1px solid black; margin-right: 10px;"> <tr><td style="padding: 2px;">(CO)</td></tr> <tr><td style="width: 20px; height: 15px;"></td></tr> </table> or <table style="display: inline-table; border: 1px solid black;"> <tr><td style="padding: 2px;">INTERCOM</td></tr> <tr><td style="width: 20px; height: 15px;"></td></tr> </table> </div> <p>Press CO or INTERCOM which is flashing green slowly.</p> <div style="border: 1px solid gray; padding: 5px; margin-top: 10px;"> <ul style="list-style-type: none"> The CO or INTERCOM indicator light turns steady green. </div>	(CO)		INTERCOM		<p><i>At the holding extension;</i></p> <div style="text-align: center;">  </div> <p>Lift the handset.</p> <div style="text-align: center;"> <table border="1" style="display: inline-table; margin-right: 10px;"> <tr><td style="padding: 5px;">5</td></tr> </table> <table border="1" style="display: inline-table;"> <tr><td style="padding: 5px;">0</td></tr> </table> </div> <p>Dial 50.</p>	5	0
(CO)							
INTERCOM							
5							
0							

Conditions

- To retrieve a call on hold at another extension, refer to 4.3.18 Call Hold Retrieve.
- Music on Hold**
"Music on Hold" is sent to the party on hold, if available.
- What if a call on hold is not retrieved?**
If a call on hold is not retrieved in a specified period of time (default: 60 s), Hold Recall (if the extension on-hook) or Hold Warning tone (if engaged in another call) rings the extension where the call is held. Refer to 6.1.3 Tone List for details about Tone Patterns.

- **Automatic Disconnection**

If a call (outside, extension) placed on hold is not retrieved within 30 minutes, it is automatically disconnected.

<PT>

- With outside calls, you can put multiple calls on hold. However, with intercom calls, you can put only one call on hold.

<ISDN Telephone>

- This feature is not available for ISDN telephones.

Programming Guide References

[200] Hold Recall Time

Features Guide References

Hold Recall

User Manual References

4.3.18 Call Hold Retrieve

4.3.17 Call Hold, Exclusive [PT only]

Allows you to prevent other extension users from retrieving your held call. A call put on exclusive hold can only be retrieved from the extension that placed it on hold.

To place a call on exclusive hold

PT

During a conversation;

HOLD

Press **HOLD**.

HOLD

Press **HOLD** again.

- The CO or INTERCOM indicator light flashes green moderately.
- The current call is placed on exclusive hold.

- The CO or INTERCOM indicator light flashes green slowly.
- The current call is placed on hold.

Retrieving a call on exclusive hold

PT

(CO)

OR

INTERCOM

Press the **CO** or **INTERCOM** which is on exclusive hold.

- The CO or INTERCOM indicator light turns steady green.
- You can talk to the held party again.

Conditions

- What if a call on Exclusive Hold is not retrieved?**
If a call on Exclusive Hold is not retrieved in a specific period of time (default: 60 s), Hold Recall (if the extension is on-hook) or Hold Warning tone (if engaged in another call) rings the extension where the call is held. After this, the held call can be retrieved from any other extension. Refer to 6.1.3 Tone List for details about Tone Patterns.
- Automatic Disconnection**
If a outside call placed on hold is not retrieved in 30 minutes, it is automatically disconnected.
- With outside calls, you can put multiple calls on exclusive hold. However, with intercom calls, you can put only one call on exclusive hold.

Programming Guide References

[200] Hold Recall Time

Features Guide References

Hold Recall

User Manual References

4.3.16 Call Hold

4.3.18 Call Hold Retrieve

Allows you to retrieve a call that has been placed on hold at other extensions.

Retrieving an outside call on hold

PT and SLT

At the other extension;



Lift the handset or press SP-PHONE/MONITOR.

5

3

Dial **53**.

outside line no.

Enter the held **outside line number**.
(01-08 for KX-TD816 / 01-48 for KX-TD1232)



Confirmation tone (optional)

PT

At the other extension;

(CO)

Press **CO** whose indicator is flashing red slowly.

- The CO indicator light turns steady green.

Retrieving an intercom call on hold

PT and SLT

At the other extension;



Lift the handset or press SP-PHONE/MONITOR.

5

1

Dial **51**.

extension no.

Dial the **extension number** at which a call is placed on hold.



Confirmation tone (optional)

Conditions

- **Confirmation Tone**
A confirmation tone is sent to the extension user who retrieved the held call. Eliminating the tone is programmable.
- "Call Park" cannot be retrieved by this feature.

<ISDN Telephone>

- This feature is not available for ISDN telephones.

Programming Guide References

[990] System Additional Information

User Manual References

4.3.16 Call Hold

4.3.19 Call Park

Allows you to place a held call into a system parking area. You can be released from the parked call to perform other operations. The parked call can be retrieved from any extension. Up to ten calls can be parked.

Parking a call

PT and SLT

During a conversation;

TRANSFER

For PT



For SLT

For PT: Press **TRANSFER**.
For SLT: Flash the hookswitch.



Confirmation tone
and dial tone

5

2

Dial **52**.

parking zone no.

Enter a **parking zone number** (0 through 9).



Confirmation tone
and dial tone

<PT Display Example>

Call Parked at x

Parking zone number
(0 through 9)

- If you hear a busy tone, it indicates the specified parking zone is unavailable.

<PT Display Example>

Park at x N/A

- You can change the parking zone simply by entering the parking zone number while hearing the busy tone.

Retrieving a parked call

PT and SLT



Lift the handset or press
SP-PHONE/MONITOR.

5

2

Dial 52.

parking zone no.

Enter a **parking zone number**
(0 through 9) where the call
is parked.



Confirmation tone
(optional)

You can talk
to the party.

- If there is no held call, you will hear a reorder tone.

<PT Display Example>

No Held Call

Conditions

- **Call Park Recall**

If a parked call is not retrieved in a specific period of time (default: 12 rings), "Call Park Recall" occurs. If a parked call is an outside call, it is possible to select whether "Call Park Recall" will go to the initiating extension or to Operator 1 by System Programming. If a parked call is an intercom call, "Call Park Recall" will return to the initiating extension.

- **Automatic Disconnection**

If a parked call is not retrieved in 30 minutes, it is automatically disconnected.

- **Confirmation Tone**

A confirmation tone is sent to the extension user who retrieved the parked call. Eliminating the tone is programmable.

<PT>

- With the KX-T7431, KX-T7433, KX-T7436 and KX-T7235, you can execute this feature using the display operation.

<ISDN Telephone>

- This feature is not available for ISDN telephones.

Programming Guide References

[219] Call Park Recall Time

[990] System Additional Information

User Manual References

4.5.9 KX-T7235 Display Features - System Feature Access Menu

4.5.12 KX-T7431 / KX-T7433 / KX-T7436 Display Features - System Feature Access Menu

4.3.20 Call Pickup, Directed

Allows you to answer an incoming call ringing at any other extension.

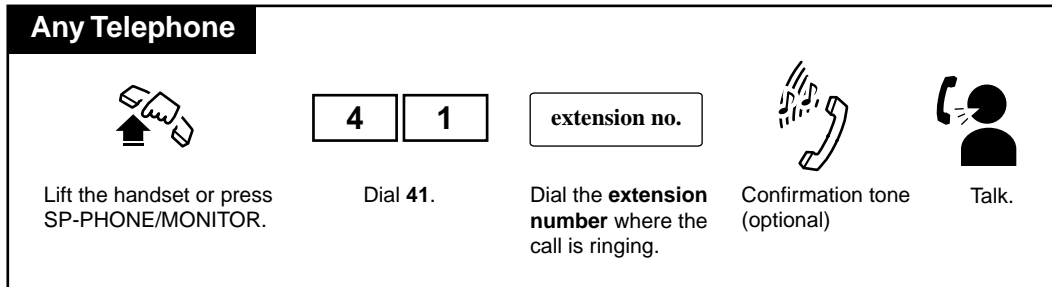

Conditions

- Doorphone calls can be picked up from extensions that are not programmed to answer doorphone calls.
- **Confirmation tone**
A confirmation tone is audible when the call is picked up. Eliminating the tone is programmable.
- If you receive a call waiting tone during a conversation, you may ask a third party to pick up your second call by Directed Call Pickup.

<PT>

- With the KX-T7431, KX-T7433, KX-T7436 or KX-T7235, you can execute this feature using the display operation.

Programming Guide References

[990] System Additional Information

User Manual References

4.3.23 Call Pickup Deny

4.5.9 KX-T7235 Display Features - System Feature Access Menu

4.5.12 KX-T7431 / KX-T7433 / KX-T7436 Display Features - System Feature Access Menu

4.3.21 Call Pickup, Group

Allows you to answer a call that is ringing at another telephone within your extension group.

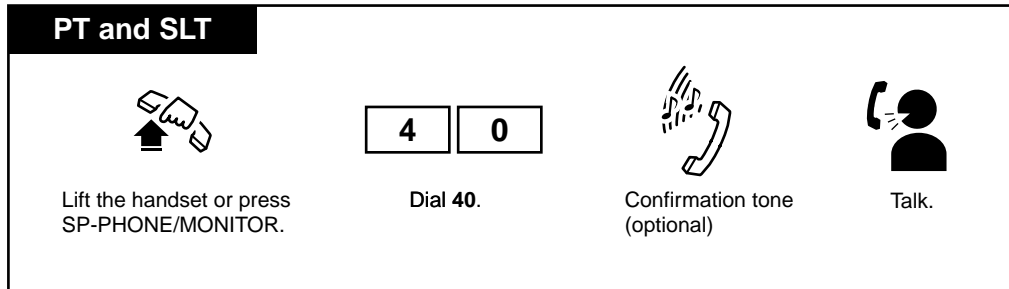

Conditions

- **Confirmation tone**
A confirmation tone is audible when the call is picked up. Eliminating the tone is programmable.
- You can pick up an incoming outside, intercom or doorphone call.

<PT>

- With the KX-T7431, KX-T7433, KX-T7436 or KX-T7235, you can execute this feature using the display operation.

<ISDN Telephone>

- This feature is not available for ISDN telephones.

Programming Guide References

[602] Extension Group Assignment

[990] System Additional Information

Features Guide References

Extension Group

User Manual References

4.3.23 Call Pickup Deny

4.3.27 Call Waiting

4.5.9 KX-T7235 Display Features - System Feature Access Menu

4.5.12 KX-T7431 / KX-T7433 / KX-T7436 Display Features - System Feature Access Menu

4.3.22 Call Pickup, Outside Line

Allows you to answer an incoming outside call that is ringing at another extension.

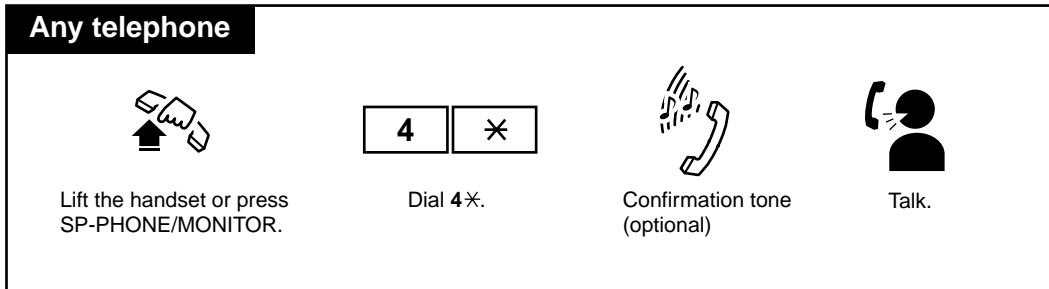

Conditions

- **Confirmation Tone**

A confirmation tone is audible when the call is picked up. Eliminating the tone is programmable.

<PT>

- With the KX-T7431, KX-T7433, KX-T7436 or KX-T7235, you can execute this feature using the display operation.

Programming Guide References

[990] System Additional Information

User Manual References

4.3.23 Call Pickup Deny

4.3.27 Call Waiting

4.5.9 KX-T7235 Display Features - System Feature Access Menu

4.5.12 KX-T7431 / KX-T7433 / KX-T7436 Display Features - System Feature Access Menu

4.3.23 Call Pickup Deny

Allows you to prevent another extension from picking up your calls with the "Call Pickup" feature.

Setting / Canceling

Any Telephone



Lift the handset or press
SP-PHONE/MONITOR.

7	2	0	1	To set
7	2	0	0	To cancel

To set: Dial **7201**.
To cancel: Dial **7200**.



Confirmation tone
and dial tone



Hang up or press
SP-PHONE/MONITOR.

<PT Display Example>

- When setting:

C.Pickup Deny
- When canceling:

C.Pickup Allow

Conditions

<PT>

- With the KX-T7431, KX-T7433, KX-T7436 or KX-T7235, you can execute this feature using the display operation.



User Manual References

- 4.3.20 Call Pickup, Directed
- 4.3.21 Call Pickup, Group
- 4.3.22 Call Pickup, Outside Line
- 4.5.9 KX-T7235 Display Features - System Feature Access Menu
- 4.5.12 KX-T7431 / KX-T7433 / KX-T7436 Display Features - System Feature Access Menu

4.3.24 Call Splitting

Allows you to have two callers on a line and alternate between them. If a call comes in while you are already on the line, you can place the current call (1st call) on hold and have a conversation with the other party (2nd call).



When you are engaged in the 2nd call (inside/outside), while placing the 1st call (inside/outside) on hold temporarily (Consultation Hold^{*1})

PT	 <p>Press TRANSFER.</p>	<ul style="list-style-type: none"> • You are connected to the 1st caller. • Pressing the TRANSFER button alternates between two callers.
SLT	 <p>Flash the hookswitch.</p>	<ul style="list-style-type: none"> • You are connected to the 1st caller. • Flashing the hookswitch alternates between two callers.

When you are engaged in the 2nd call (inside), while placing the 1st call (inside) on (exclusive) hold

PT	<p><i>Between two extensions;</i></p>  <p>Press HOLD.</p>	<ul style="list-style-type: none"> • Pressing the HOLD button alternates between two callers.
-----------	---	--

When you are engaged in the 2nd call (inside/outside), while placing the 1st call (inside/outside) on (exclusive) hold

PT	 <p>Press HOLD.</p>	 <p>Press CO or INTERCOM.</p>	<ul style="list-style-type: none"> • Repeating these operations (steps 1 and 2) alternates between two callers.
-----------	---	--	--

Conditions

- This feature does not work during a doorphone call or paging.

^{*1} Consultation Hold places a call on hold temporarily to transfer it or makes a Conference call or Call Splitting.

Features Guide References

Consultation Hold

User Manual References

4.3.16 Call Hold

4.3.17 Call Hold, Exclusive [PT only]

4.3.25 Call Transfer — to Extension

Allows you to transfer the call you received to another extension. There are two ways.

Screened Call Transfer: The destination confirms the transfer before you send it.

Unscreened Call Transfer: The line is released after transferring the call without confirmation.

Screened Call Transfer to Extension

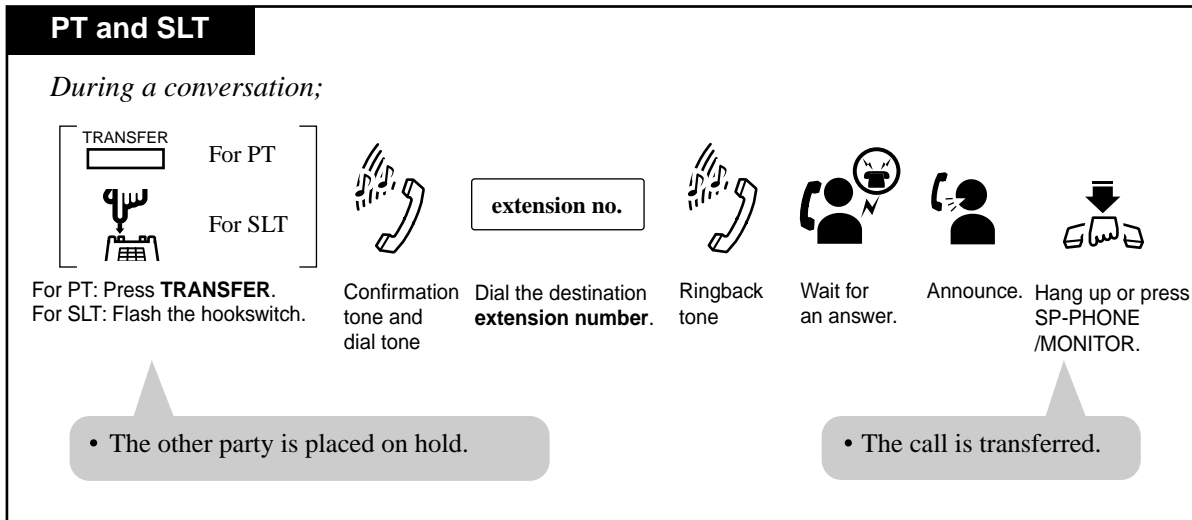

Unscreened Call Transfer to Extension

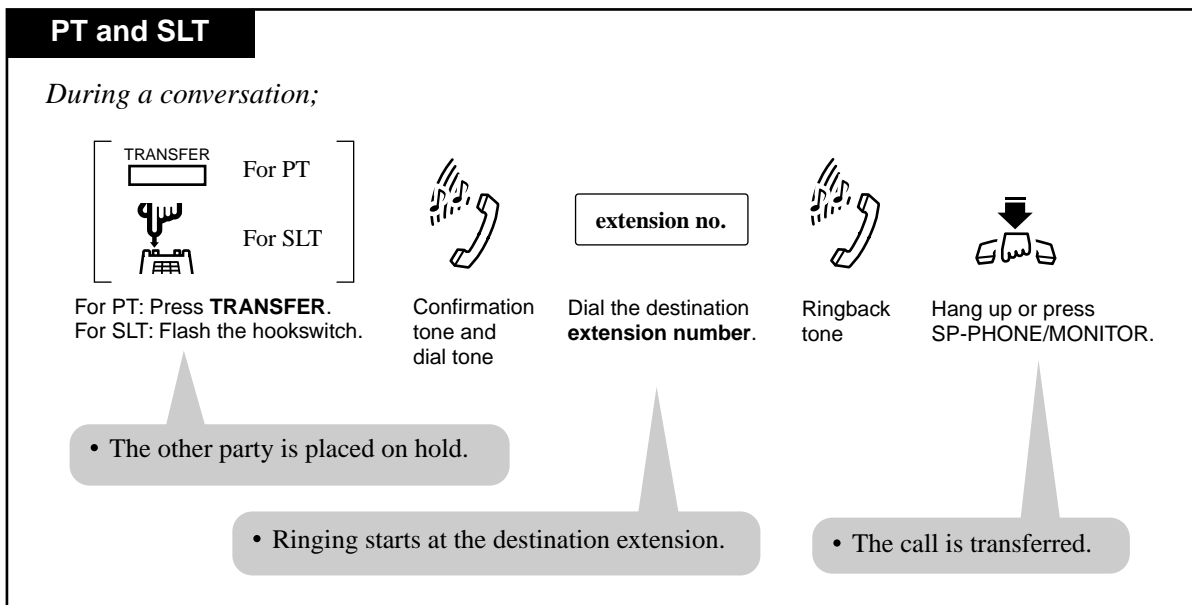

Call Transfer using a DSS button

Allows PT users to perform Screened or Unscreened Call Transfer by using a DSS button. There are two operations, depending on whether or not One-Touch Transfer^{*1} is set.

When "One-Touch Transfer" mode is enabled:

PT

During a conversation;

(DSS)



Press **DSS** (flexible button).

- The other party is placed on hold and the destination extension is called immediately.

When "One-Touch Transfer" mode is disabled:

PT

During a conversation;

TRANSFER

Press **TRANSFER**.

(DSS)

Press **DSS** (flexible button).

Conditions

- Automatic Disconnection**
If there is no answer for 30 minutes after "Transfer Recall" starts, the line will be disconnected.
- If the destination extension does not answer the call within twelve rings (default), "Transfer Recall" occurs. If the transferred call is an outside call, it is possible to select whether Transfer Recall will go to the initiating extension or to Operator 1 by System Programming.
- An outside call can be translated directly to a Uniform Call Distribution (UCD) group so that an idle extension is automatically hunted by UCD.

^{*1} One-Touch Transfer allows you to hold an outside call and transfer it to an extension by pressing one key. This feature provides automatic hold and transfer, without pressing the TRANSFER button. System Programming is required to use this function.

<PT>

- The destination extension shows the Caller ID and the extension number from where the call was transferred on the display.

<Example> The Caller ID number "123456789" is transferred from extension 101.

101 → 123456789

The priority of the display is:

Caller ID name > Caller ID number > Outside line name > Blank (if none of these is assigned).

If your telephone has a two, three or six line display, both the Caller ID name and number are displayed.

- You can change the display to show the original extension number and name by System Programming.
- A flexible CO button can be assigned as a DSS button.
- To use "One-Touch Transfer", System Programming is required.
- Pressing the FLASH button while dialing clears the display. Then you can enter the revised number.
- If you want to return to the held call, press the TRANSFER button or corresponding CO, INTERCOM button before the destination extension answers.
- When "Transfer Recall" occurs, the display shows:

<Example>

RCL: Ext 103

<SLT>

- If you want to return to the held call, flash the hookswitch before the destination extension answers.

<ISDN Telephone>

- This feature is not available for ISDN telephones.

Programming Guide References

[108] Automatic Hold by CO / DSS Button

[201] Transfer Recall Time

[990] System Additional Information

User Manual References

2.2.2 Flexible Button Assignment

4.3.84 Uniform Call Distribution (UCD)

4.3.26 Call Transfer — to Outside Line

You can transfer a call (intercom, outside) to an outside party via outside line.

Screened Call Transfer

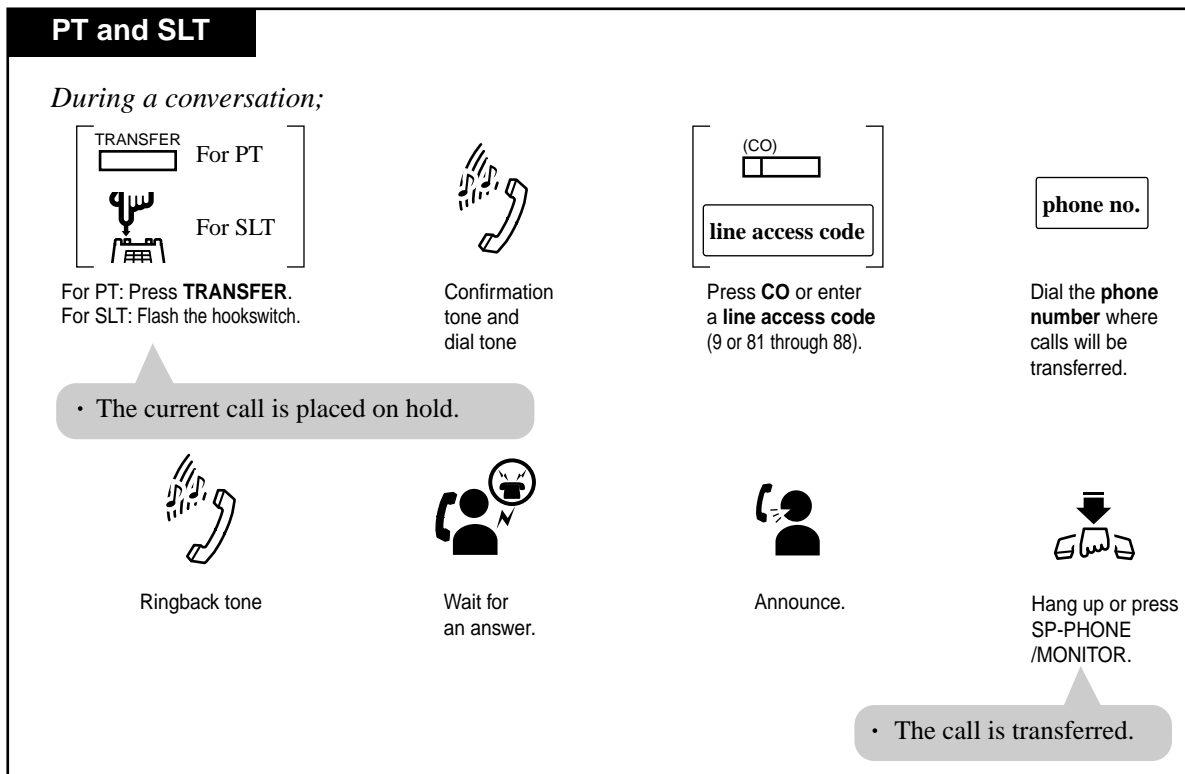

Conditions

- **Class of Service**
Class of Service programming determines the extensions that can perform this feature.
- **Outside-to-outside call**
If an outside call is transferred to an outside party, "outside-to-outside call" is established and the call duration is restricted by a system timer "Outside-to-Outside Line Call Duration Time (1-64 min)".
Hold Recall tone
Hold Recall tone is generated to the extension who transferred the call 50 seconds before the time-out.
Hold Alarm tone
Hold Alarm tone is generated to both outside parties 15 seconds before the time-out. The call is disconnected at the time-out unless the extension user (who transferred the call) joins the outside-to-outside call to establish a conference call.

<PT>

- Pressing the FLASH button while dialing clears the display. Then you can enter the revised number.

- If you want to return to the held call, press the TRANSFER button or corresponding CO or INTERCOM button before the destination party answers.
- If you want to join the conversation after transferring the call or while hold recall tone is sent, press the corresponding CO button. A conference call is established.

<ISDN Telephone>

- This feature is not available for ISDN telephones.

Programming Guide References

[206] Outside-to-Outside Line Call Duration Time

[503] Call Transfer to Outside Line

[601] Class of Service

Features Guide References

Hold Recall

4.3.27 Call Waiting

During a call, a Call Waiting tone informs you that there is another call waiting for you. You can answer the second call by disconnecting or placing the current call on hold. PT users can choose one of three Call Waiting modes.

Setting

PT



Lift the handset or press SP-PHONE/MONITOR.

1. Call Waiting BSS	7	3	1	1
2. Call Waiting OHCA	7	3	1	2
3. Call Waiting W-OHCA	7	3	1	3

1. Dial **7311**.
2. Dial **7312**.
3. Dial **7313**.



Confirmation tone and dial tone



Hang up or press SP-PHONE/MONITOR.

<PT Display Example>

BSS : Call Waiting 1

OHCA : Call Waiting 2

W-OHCA : Call Waiting 3

SLT



Lift the handset.

7	3	1	1
---	---	---	---

Dial **7311**.



Confirmation tone and dial tone



Hang up.

Canceling

PT and SLT



Lift the handset or press SP-PHONE/MONITOR.

7	3	1	0
---	---	---	---

Dial **7310**.



Confirmation tone and dial tone







Hang up or press SP-PHONE/MONITOR.



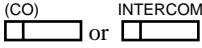



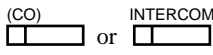

<PT Display Example>

Call Waiting Off

To talk to the new party by terminating the current call

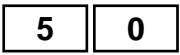
PT	SLT
<p><i>While hearing a Call Waiting tone;</i></p> <div style="display: flex; justify-content: space-around; align-items: center;"> <div style="text-align: center;">  <p>Press the flashing CO or INTERCOM.</p> </div> <div style="text-align: center;">  <p>Talk to the new caller.</p> </div> </div> <div style="border: 1px solid gray; border-radius: 15px; padding: 5px; margin-top: 10px; background-color: #f0f0f0;"> <ul style="list-style-type: none"> • The current call is disconnected. </div>	<p><i>While hearing a Call Waiting tone;</i></p> <div style="display: flex; justify-content: space-around; align-items: center;"> <div style="text-align: center;">  <p>Hang up.</p> </div> <div style="text-align: center;">  <p>Lift the handset.</p> </div> <div style="text-align: center;">  <p>Talk to the new caller.</p> </div> </div> <div style="border: 1px solid gray; border-radius: 15px; padding: 5px; margin-top: 10px; background-color: #f0f0f0;"> <ul style="list-style-type: none"> • The current call is disconnected. </div>

To talk to the new party by holding the current call

PT
<p><i>While hearing the Call Waiting tone and the CO or INTERCOM indicator is flashing rapidly;</i></p> <div style="display: flex; justify-content: space-around; align-items: center;"> <div style="text-align: center;">  <p>Press HOLD.</p> </div> <div style="text-align: center;">  <p>Press the flashing CO or INTERCOM.</p> </div> <div style="text-align: center;">  <p>Talk to the new caller.</p> </div> </div> <div style="border: 1px solid gray; border-radius: 15px; padding: 5px; margin-top: 10px; background-color: #f0f0f0;"> <ul style="list-style-type: none"> • The current call is placed on hold. • If both the current call and new call are extension calls, you will be connected to the new caller simply by pressing HOLD. </div>
SLT
<p><i>While hearing a Call Waiting tone;</i></p> <div style="display: flex; justify-content: space-around; align-items: center;"> <div style="text-align: center;">  <p>Flash the hookswitch.</p> </div> <div style="text-align: center;">  <p>Confirmation tone and dial tone</p> </div> <div style="text-align: center;">  <p>Dial 50.</p> </div> <div style="text-align: center;">  <p>Dial tone</p> </div> <div style="text-align: center;">  <p>Hang up.</p> </div> <div style="text-align: center;">  <p>Lift the handset.</p> </div> <div style="text-align: center;">  <p>Talk to the new caller.</p> </div> </div> <div style="border: 1px solid gray; border-radius: 15px; padding: 5px; margin-top: 10px; background-color: #f0f0f0;"> <ul style="list-style-type: none"> • The current call is placed on hold. </div>

Conditions

- **BSS / OHCA / Whisper OHCA**

If an extension user dials "1" while hearing a busy tone, BSS or OHCA or Whisper OHCA may be activated at the called extension.

This is determined by the following conditions.

Calling extension	Called extension			
COS-OHCA assignment	Call Waiting setting			
	OFF	ON		
	0	1	2	3
Disable	————	BSS	BSS	BSS
Enable	————	BSS	OHCA*1 → BSS	W-OHCA*2 → OHCA → BSS

*1 OHCA (Off-Hook Call Announcement) is activated when the called extension is KX-T7235 or KX-T7436.

*2 Whisper OHCA is activated when both calling and called extensions are using one of the KX-T7400 series PT.

- The call waiting tone is generated when an outside call, a doorphone call is received, or when an extension caller executes Busy Station Signaling.

- **Data Line Security**

Setting Data Line Security temporarily cancels Call Waiting which has been turned on by an extension user.

<PT>

- **Call Waiting Tone Type Selection**

For PT users, two types of call waiting tones are provided to prevent them from missing the tone. A Call Waiting Tone type can be selected either by Station or System Programming.

- With the KX-T7431, KX-T7433, KX-T7436 and KX-T7235, you can set or cancel this feature using the display operation.

<ISDN Telephone>

- This feature is not available for ISDN telephones.

User Manual References

2.2.1 Initial Settings

4.3.7 Busy Station Signaling (BSS)

4.3.33 Data Line Security

4.3.56 Off-Hook Call Announcement (OHCA)

4.3.57 Off-Hook Call Announcement (OHCA) —Whisper [PT only]

4.5.9 KX-T7235 Display Features - System Feature Access Menu

4.5.12 KX-T7431 / KX-T7433 / KX-T7436 Display Features - System Feature Access Menu

4.3.28 Call Waiting from Central Office

During a conversation, a call waiting tone offered by the local Central Office signals your extension that there is another call waiting. You can answer the second call by placing the first call on hold.

7230 / 7235 / 7433 / 7436

While hearing a Call Waiting tone through the handset;

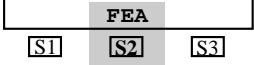

Press **EFA(S2)**.

- The current call is placed on hold and you can talk to the second caller.

Using the FLASH button

PT

While hearing a Call Waiting tone through the handset;



Press **FLASH**.

- The current call is placed on hold and you can talk to the second caller.

Using the feature number

SLT

While hearing a Call Waiting tone through the handset;



Flash the hookswitch. Dial **6**.

- The first party is placed on hold.
- You can talk to the second party.

Conditions

- This is an optional telephone company service.
For more information, consult the local telephone company.

<PT>

- You can return to the original party by pressing the FLASH or EFA (S2) button again.

<SLT>

- You can return to the original party by flashing the hookswitch and then dialing 6 again.

4.3.29 Camp-On Transfer to Phantom Extension

Allows you to transfer a call to busy phantom extensions.
The call is transferred when at least one extension becomes free.

PT

During a conversation;



Press **TRANSFER**.



Confirmation tone





Dial tone

phantom extension no.

Dial the destination **phantom extension number**.



Busy tone

Hang up or press SP-PHONE/MONITOR.

SLT

During a conversation;



Flash the hookswitch.



Confirmation tone





Dial tone

phantom extension no.

Dial the destination **phantom extension number**.



Busy tone

Hang up.

Conditions

- If the destination extension does not become free within twelve rings (default), "Transfer Recall" occurs. If the transferred call is an outside call, it is possible to select whether Transfer Recall will go to the initiating extension or to Operator 1 by System Programming.
- If there is no answer within thirty minutes after "Transfer Recall" starts, the line will be disconnected.

<PT>

- If you misdial, press the FLASH button, and re-enter the number.

<SLT>

- If you want to return to the held call, flash the hookswitch before the destination extension answers.

Programming Guide References

[201] Transfer Recall Time

[990] System Additional Information

User Manual References

4.3.67 Phantom Extension

4.3.30 Conference

During a two-party conversation, you can add a third party to make a three-party conference. The members of a conference on a line may be three extensions, one extension and two outside lines, or two extensions and one outside line.

To establish a conference

PT

During a two-party conversation;

Press **CONF**. Confirmation tone and dial tone

Dial the **phone number** of the third party.

Talk to the third party.

Press **CONF**. Confirmation tone (optional)

A three-party conference is now established.

- The current party is placed on hold.
- The CONF indicator light flashes red slowly.
- You must dial a line access code (9 or 81 through 88) as the first digit when calling an outside party.
- The CONF indicator light turns steady red.
- The corresponding CO or INTERCOM indicator light turns green.

SLT

During a two-party conversation;

Flash the hookswitch. Confirmation tone and dial tone

Dial the **phone number** of the third party.

Talk to the third party.

Flash the hookswitch.

Dial **3**. Confirmation tone (optional)

A three-party conference is now established.

- The other party is placed on hold.
- You must dial a line access code (9 or 81 through 88) as the first digit when calling an outside party.

To leave the conference

PT and SLT



Hang up or press SP-PHONE/MONITOR.

- The other two parties may continue their conversation.
- If both other two parties are on outside lines, they will be disconnected.

To terminate one party and talk to the other

PT

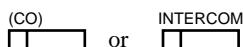

Press the **CO** or **INTERCOM** of the party to remain connected.



Confirmation tone (optional)



Talk.

- A conversation with the desired party is established and the other party is disconnected.
- This operation is available only when the extension user established the conference call by using two different line access buttons. (Not available when only one button is used.)

To talk to the third party while holding the original party

PT



Press **TRANSFER**.



Confirmation tone (optional)



Talk to the third party.

- If both other two parties are extensions, the INTERCOM indicator light flashes green moderately.

To talk to the original party while holding the third party

SLT



Flash the hookswitch.



Confirmation tone
(optional)



Talk to the original party.

To put both parties on hold

PT

HOLD

Press **HOLD**.

- This feature is only available when at least one party is on an outside line.

Conditions

- Up to six conference calls are allowed simultaneously.
- **Executive Busy Override, Privacy Release**
A 3-party conference call is also established by Executive Busy Override or Privacy Release.
- **Confirmation tone**
When a 2-party call is changed to a 3-party conference call or vice versa, a confirmation tone is sent to all three parties. Eliminating the tone is programmable.

<PT>

- Pressing a CO button which is not in the conference, allows you to exit from the conference leaving the other two parties connected unless they both are on outside lines. If they both are on outside lines, they will be disconnected.
- You can return to the original party before the third party answers by pressing the TRANSFER button.
- CONF button is not provided on your KX-T7250. However, it can be assigned to a flexible (CO, DSS, PF) button by Station, User or System Programming.

<SLT>

- You can return to the original party before the third party answers by flashing the hookswitch.

<ISDN Telephone>

- This feature is not available for ISDN telephones.

Programming Guide References

[990] System Additional Information

User Manual References

2.2.2 Flexible Button Assignment

4.3.31 Conference, Unattended [PT only]

4.3.40 Executive Busy Override — Extension

4.3.41 Executive Busy Override — Outside Line [PT only]

4.3.69 Privacy Release [PT only]

4.3.31 Conference, Unattended [PT only]

When you are in a conference with two outside parties, you can leave the three-party conference allowing the other two parties to continue their conversation.

To establish an Unattended Conference

PT

During a conversation with two outside parties;



Press **CONF** to leave the conference.

- An outside-to-outside line call between the other two parties is established.

To return to the conference

PT



Press **CO** flashing green moderately.

To answer Hold Recall (To return to the conference on the line)

PT

While hearing Hold Recall;



Lift the handset or
press SP-PHONE
/MONITOR.

or



Press **CO** button which
is flashing rapidly.

Conditions

- When an Unattended Conference is established, an alarm tone is sent to both outside parties fifteen seconds before the assigned duration time limit (default: 10 min). "Hold Recall" is activated to the extension that leaves the conference fifty seconds before the time out. The call is disconnected at the time out unless the extension returns to the conference.
- If you are off-hook and hear "Hold Recall" during the Unattended Conference mode, the display flashes "CO 02 & CO 03", for example, for five seconds at fifteen second intervals.
- Whether an extension is able to establish a "Conference, Unattended" depends on the "Class of Service*" assignment.

Programming Guide References

[206] Outside-to-Outside Line Call Duration Time

[503] Call Transfer to Outside Line

[601] Class of Service

Features Guide References

Hold Recall

User Manual References

4.3.30 Conference

*1 Class of Service (COS) is used to define the features which are allowed for a group of extensions. Refer to "Class of Service (COS)" in the Features Guide.

4.3.32 CTI (Computer Telephony Integration) Code Entry

If a CTI Service is used, a CTI Code (max. 16 digits) can be sent from the KX-TD816/KX-TD1232 to the CTI application. The code is interpreted by the application for suitable action. The feature number of CTI Code Entry is "Blank" by default. You must specify it by System Programming. For details, consult your manager or dealer.

Entering CTI code

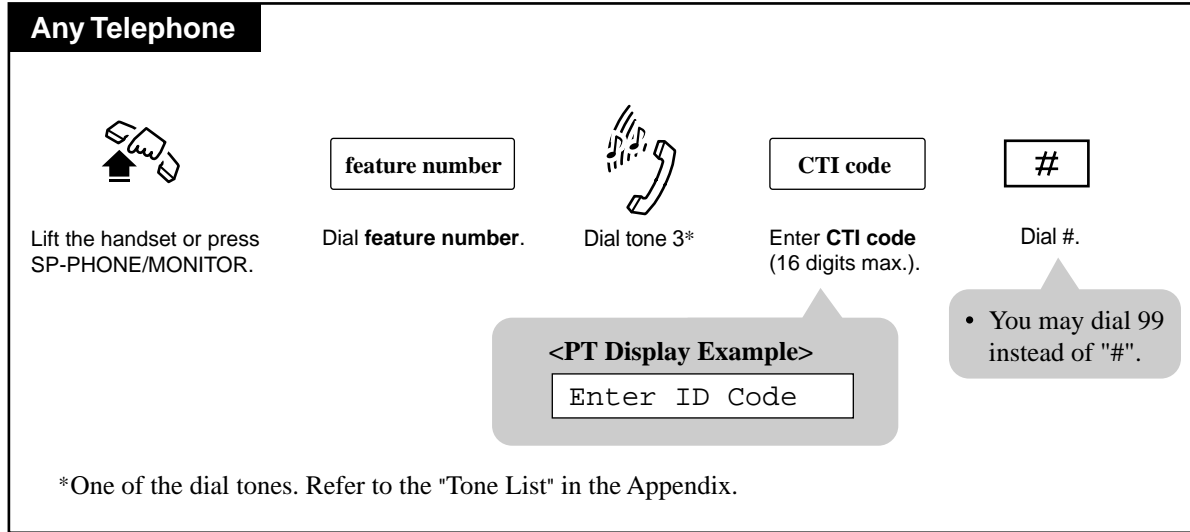

Programming Guide References

[100] Flexible Numbering

4.3.33 Data Line Security

Your extension is protected against interruptions from the "Call Waiting," "Hold Recall," and "Executive Busy Override" features. Data communication devices, such as computers and facsimiles, operate uninterrupted.

Setting / Canceling

Any Telephone



Lift the handset or press
SP-PHONE/MONITOR.

7	3	0	1
To set			
7	3	0	0
To cancel			

To set: Dial **7301**.
To cancel: Dial **7300**.



Confirmation tone
and dial tone



Hang up or press
SP-PHONE/MONITOR.

<PT Display Example>

- When setting:
-
- When canceling:
-

Conditions

- **Automatic Privacy**
Assigning Data Line Security always offers conversation privacy unless Privacy Release is executed.
- If one extension in a conversation has set Data Line Security, it applies to the both extensions.

<PT>

- With the KX-T7431, KX-T7433, KX-T7436 or KX-T7235, you can execute this feature using the display operation.

Features Guide References

Hold Recall

User Manual References

- 4.3.27 Call Waiting
- 4.3.41 Executive Busy Override — Outside Line [PT only]
- 4.3.40 Executive Busy Override — Extension
- 4.3.69 Privacy Release [PT only]

4.5.9 KX-T7235 Display Features - System Feature Access Menu

4.5.12 KX-T7431 / KX-T7433 / KX-T7436 Display Features - System Feature Access Menu

4.3.34 Direct Inward System Access (DISA)

Allows an outside caller to access specific system features as if the caller is an extension in the system. A DISA outgoing message is used to give outside callers assistance, such as listing the extension numbers in the system. The pre-assigned DISA user code may be necessary depending on the mode to have direct access to the features within the system.

Warning for the Direct Inward System Access Users

When you enable the Outside - Outside Line Call feature of **Direct Inward System Access (DISA) function**, if a third party discovers the password (a DISA User Code) of the system, you have a risk that they will make illegal phone calls using your telephone line, and the cost may be charged to your account.

In order to avoid this problem, we strongly recommend the following points:

- 1: Carefully maintain the secrecy of the password.
- 2: Specify a complicated password as long and random as you can make it.
- 3: Change the password frequently.

Calling an extension

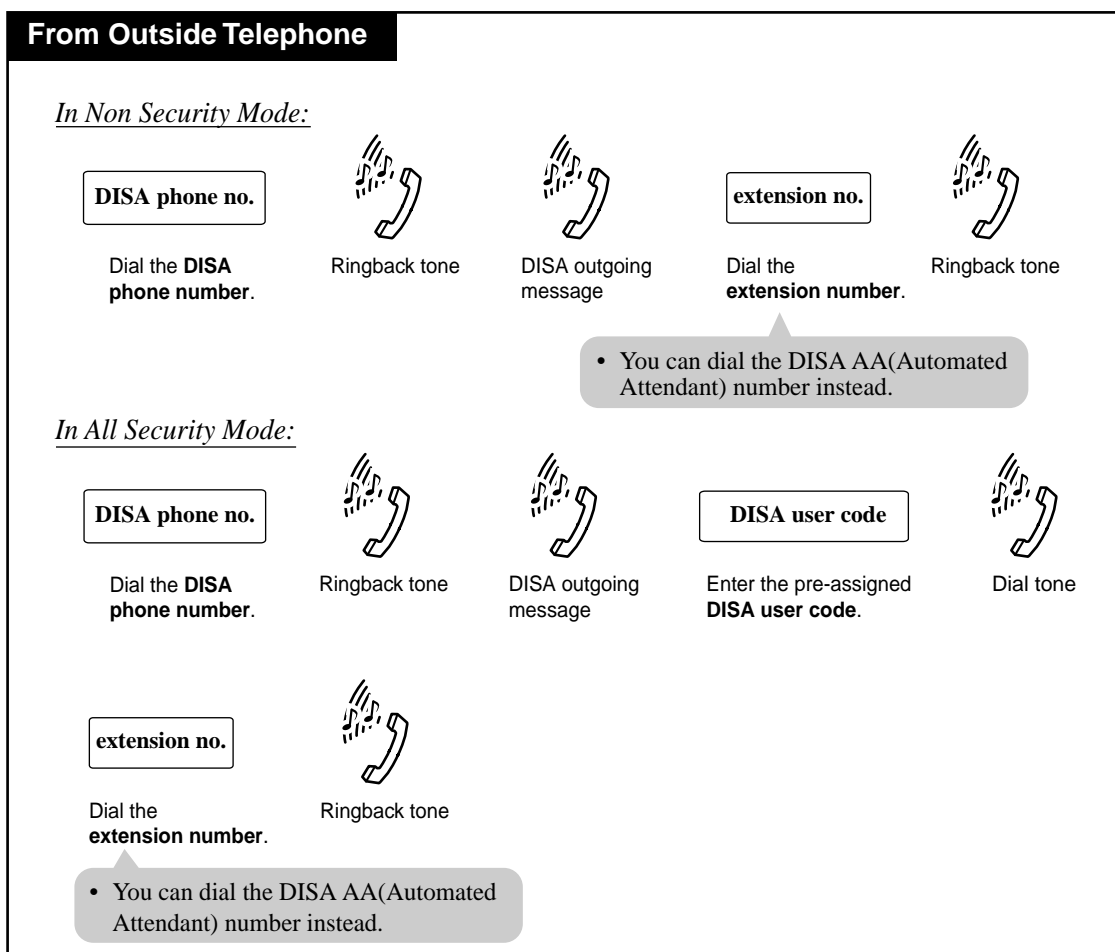

Calling an outside party

From Outside Telephone

In Non Security Mode:

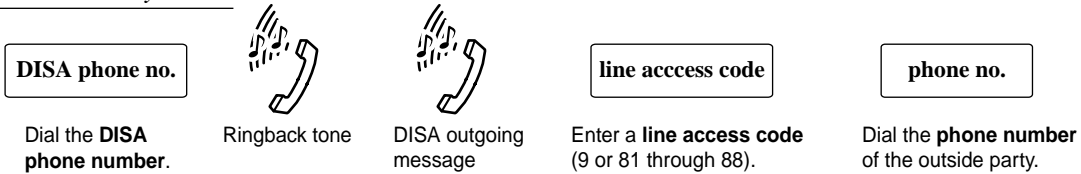

In Outside Line Security Mode:

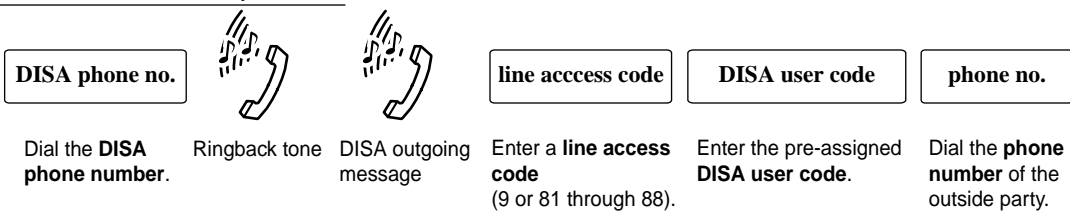

In All Security Mode:



Extending the call duration while calling an outside line

From Outside Telephone

When you make a call to any outside line using the DISA feature, the line is disconnected after a preprogrammed time (default: 10 min). However, you can prolong your call by pressing a key. Your call is prolonged by a preprogrammed period of time (default: 3min). You prolong a call an infinite number of times by default (this can be limited to ten times).

any key except "✖"

Dial **any key except "✖"** after the warning tone.

Re-try

From Outside Telephone

It is possible (by System Programming) to dial a different number during a conversation with an outside party or while hearing a ringback, reorder, or busy tone.



Press *.



Dial the **desired number**.

- You hear a dial tone.
- If you dial " * "while hearing a DISA outgoing message, dial tone, or after the DISA outgoing message, the call will be disconnected.

- You must dial a line access code (9 or 81 through 88) when calling an outside party.

Conditions

Calling an extension

- You can choose Non Security or All Security mode. In All Security mode, the caller must enter a pre-assigned DISA user code to make intercom calls.
- If the DISA call is not answered within a specified period of time, the system redirects it to the pre-determined IRNA destination.
If IRNA destination is not programmed, the DISA call continues to ring at the first destination extension.

Calling an outgoing outside line

- You can choose Non Security, Outside Line Security or All Security mode. In Outside Line Security mode, the caller must enter a pre-assigned DISA user code to make outside calls. In All Security mode, the caller must enter a pre-assigned DISA user code to make both outside and intercom calls.

General

- If the caller does not dial any digits during and after the playback of DISA outgoing message, the system will direct him or her to the pre-determined destination (Intercept Routing). "Intercept Routing" is activated 5 seconds after (default) or immediately after the playback depending on System Programming.
- **DISA User Code**
You can store up to 32 programmable DISA user codes. These codes can have four to ten digits, and they must be unique. You can assign a "Class of Service" number to each code. The "Class of Service" appended to the code denies the "Toll Restriction".
- **DISA User Code Entry Failure**
If the DISA caller fails to enter the valid DISA user code three times consecutively, the call will be disconnected.
- **DISA built-in Automated Attendant Number**
This system supports up to ten programmable DISA built-in auto attendant numbers. After listening to the DISA message, you can dial a single digit.

The DISA built-in auto attendant number may be the same as the first digit of other numbers (extension number, Floating Number, etc.). To avoid confusion, the system waits for the second digit for a pre-programmed amount of time (default: 1 s). If the second digit is not dialed until the timer expires, the system assumes that the first digit is a DISA built-in auto attendant number.

- **DISA Call Duration**
Extending the call duration can be enabled (from 1 to 7 minutes) or disabled by System Programming. The caller can extend the call duration up to 10 times, or as many times as the caller wants (no limit) depending on System Programming.
- **Outside-to-Outside line call duration**
When the "Outside-to-Outside Line Call Duration Time" expires, both lines are disconnected unless the caller re-tries or extends the time (default: 3 min), if available. A warning tone is sent at five second intervals to both parties, fifteen seconds before the time limit.

Programming Guide References

<To enable DISA feature>

- [017] DISA User Codes
- [407-408] DIL 1:1 Extension — Day / Night
- [809] DISA Security Type
- [813] Floating Number Assignment
- [815] DISA Built-in Auto Attendant
- [990] System Additional Information

<To set DISA timer values>

- [202] Call Forwarding — No Answer Time
- [206] Outside-to-Outside Line Call Duration Time
- [214] DISA Prolong Time
- [218] DISA AA Wait Time

<To enable the Intercept Routing feature>

- [203] Intercept Time
- [409-410] Intercept Extension — Day / Night
- [990] System Additional Information

Features Guide References

Intercept Routing

User Manual References

4.4.6 Outgoing Message (OGM)

4.3.35 Do Not Disturb (DND)

Allows you to prevent other parties from disturbing you. Your extension will not receive intercom and outside calls.

Setting

7235 / 7436

Lift the handset or press SP-PHONE.

Press **FWD/DND**.

Press **Do Not Disturb (F2)**.

Confirmation tone and dial tone

Hang up or press SP-PHONE.

<PT Display Example>
Do Not Disturb

Canceling

7235 / 7436

Lift the handset or press SP-PHONE.

Press **FWD/DND**.

Press **FWD/DND Cancel (F1)**.

Confirmation tone and dial tone

Hang up or press SP-PHONE.

<PT Display Example>
FWD/DND Cancel

Setting / Canceling

PT and SLT



Lift the handset
or press
SP-PHONE/MONITOR.

FWD/DND

7

1

0

For PT: Press **FWD/DND**.
For PT, SLT: Dial **710**.

1

0

To set: Dial **1**.
To cancel: Dial **0**.



Confirmation tone
and dial tone



Hang up or press
SP-PHONE/MONITOR.

- When setting, the FWD/DND indicator lights.

Do Not Disturb
- When canceling, the FWD/DND indicator light turns off.

FWD/DND Cancel

Conditions

- DND also works for an incoming call from a doorphone.
- DND does not work for the following calls:**
 - Hold Recall
 - Timed Reminder Alarm Tone
- Do Not Disturb Override**
An extension in DND mode can be called by other extension users who are allowed to override DND in their Class of Service.

<PT>

- An extension user may have only one type of Call Forwarding / Do Not Disturb feature in effect at any time. If one of Call Forwarding/Do Not Disturb feature is assigned, another does not function but the assignment itself is preserved for future use. The extension user can choose either one by pressing the FWD/DND button while on-hook. In this case, pressing the button changes the settings as follows:



- The lighting patterns of the FWD/DND button are as follows:

Off : Both functions are canceled

Red on : DND mode This setting can be changed
 Red flash : FWD mode by System Programming.

- A PT user in DND mode can answer a call by pressing a flashing button which shows the arrival of the call.

<7250>

- A flexible button on the KX-T7250 (no FWD/DND button provided) can be assigned as the FWD/DND button.

<ISDN Telephone>

- This feature is not available for ISDN telephones.

User Manual References

2.2.2 Flexible Button Assignment

4.3.8 Call Forwarding — SUMMARY

4.3.36 Do Not Disturb (DND) Override

4.5.2 Call Forwarding / Do Not Disturb (KX-T7436 / KX-T7235 only)

4.3.36 Do Not Disturb (DND) Override

You can override the "Do Not Disturb (DND)" feature set on the other extension, if permitted by System Programming beforehand.

PT

If you make an intercom call and hear the Do Not Disturb (DND) tone;

Press **Over (S2)**.

Wait for an answer and talk.

<PT Display Example>
101: DND

PT and SLT

If you hear Do Not Disturb (DND) tone after making an intercom call;

DND tone

Dial 1.

Wait for an answer and talk.

<PT Display Example>
101: DND

Conditions

- **Class of Service**
Class of Service (COS) programming determines the extension that can perform this feature.
- If you hear a reorder tone after dialing 1, your extension is not permitted to execute "Do Not Disturb (DND) Override" feature by System Programming.
- **What if a busy tone is heard after DND override?**
The other extension in DND mode is busy.
In this case, you may perform the following features.
 - Automatic Callback (Camp-on)
 - Busy Station Signaling (BSS)
 - Off-Hook Call Announcement (OHCA)

- Whisper OHCA
- Executive Busy Override

<ISDN Telephone>

- This feature is not available for ISDN telephones.

Programming Guide References

[507] Do Not Disturb Override

[601] Class of Service

User Manual References

4.3.35 Do Not Disturb (DND)

4.3.37 Doorphone Call

Allows you to have a conversation with a visitor at your doorphone. You can also unlock the door from your telephone.

Calling an extension from a doorphone — operation for a visitor

Doorphone



Press the Doorphone button for one second.



Wait for an answer and talk.

Answering a doorphone call

Any Telephone

When you hear the doorphone ring tone at the extension;



Lift the handset or press SP-PHONE/MONITOR.

Calling a doorphone

Any Telephone



Lift the handset or press SP-PHONE/MONITOR.

3

1

Dial 31.

doorphone no.

Enter a **doorphone number**
(1 or 2 for KX-TD816 /
1 through 4 for KX-TD1232).



Confirmation tone



Talk.

<PT Display Example>

Doorphone x

doorphone number
(1 through 4)

To unlock the door from an assigned extension

Any Telephone

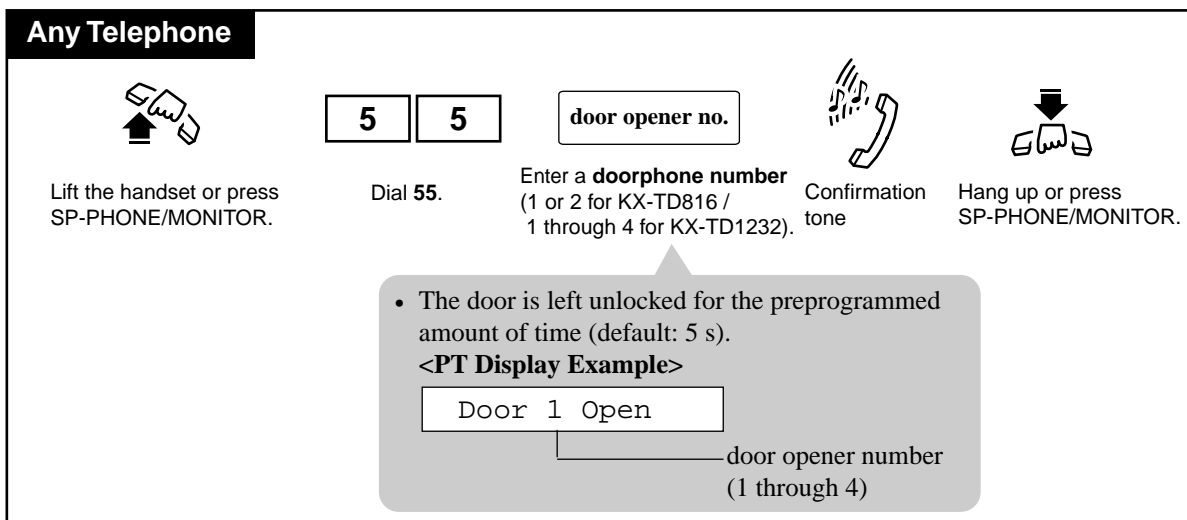

Lift the handset or press SP-PHONE/MONITOR.

Dial **55**.

Enter a **doorphone number** (1 or 2 for KX-TD816 / 1 through 4 for KX-TD1232).

Confirmation tone

Hang up or press SP-PHONE/MONITOR.

- The door is left unlocked for the preprogrammed amount of time (default: 5 s).

<PT Display Example>

Door 1 Open

door opener number (1 through 4)

To unlock the door while talking to the visitor at the doorphone from any extension

PT

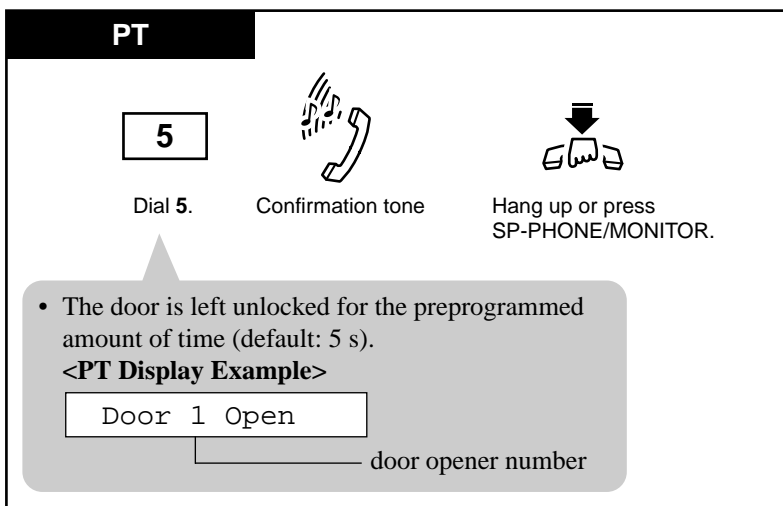

Dial **5**.

Confirmation tone

Hang up or press SP-PHONE/MONITOR.

- The door is left unlocked for the preprogrammed amount of time (default: 5 s).

<PT Display Example>

Door 1 Open

door opener number

SLT

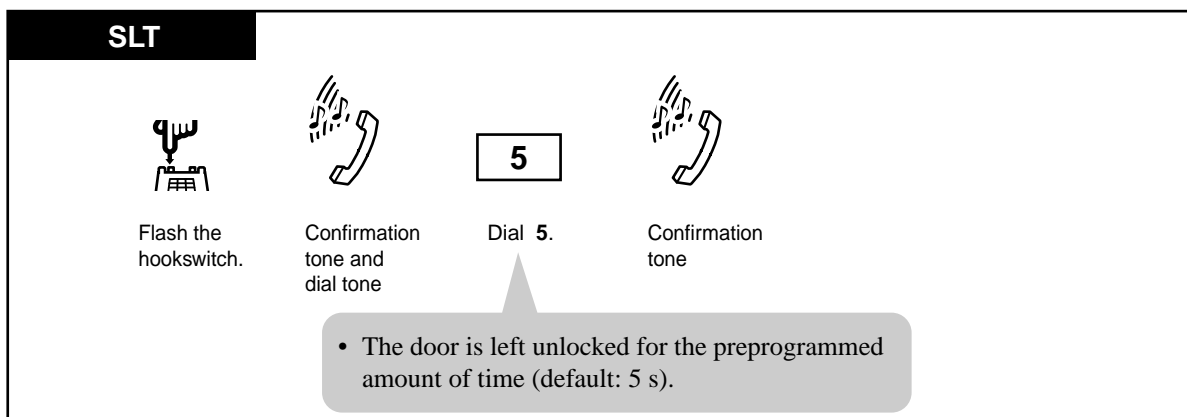

Flash the hookswitch.

Confirmation tone and dial tone

Dial **5**.

Confirmation tone

- The door is left unlocked for the preprogrammed amount of time (default: 5 s).

Conditions

- An optional Doorphone Card and a doorphone are necessary for this feature.
- If you dial "5" again while the door is open, the door will stay open for another five seconds.
- An access tone can be programmed not to be sent to the monitored doorphone before monitoring starts.
- **Doorphone Call Destination**
It is necessary to program the extensions that can receive doorphone calls during day and night mode.
- **What if a doorphone call is not answered?**
If not answered within 30 seconds, the call stops ringing and is canceled.
- **Unlocking the door opener**
During a doorphone call, any extension user can unlock the door opener (user-supplied) from their extensions by dialing "5" to let the visitor in.
- You cannot hold and transfer the doorphone call.
- The door can be unlocked by the following:
 - 1) Extensions that are programmed to receive doorphone calls.
 - 2) Any extension that is engaged in a doorphone call.
- The door opener will open the door, even if a doorphone is not installed.
- You can modify the door opener timer from five seconds (default) to three seconds by System Programming.

<PT>

- While talking to a doorphone, you can unlock the door using the one-touch dialing button instead of dialing "5." In this case, "5" must be stored in the one-touch dialing button by Station or System Programming.
- You can assign a ringer frequency (8 types) to each doorphone by System Programming. This is only available for DPT.
- With the KX-T7431, KX-T7433, KX-T7436 or KX-T7235, you can call a doorphone and open a door using the display operation.

Programming Guide References

[607-608] Doorphone Ringing Assignment — Day / Night

[818] Doorphone Tone Frequency Selection

[820] Doorphone Ringing Time

[990] System Additional Information

User Manual References

2.2.2 Flexible Button Assignment

4.5.9 KX-T7235 Display Features - System Feature Access Menu

4.5.12 KX-T7431 / KX-T7433 / KX-T7436 Display Features - System Feature Access Menu

4.3.38 Electronic Station Lockout

Allows you to lock your extension so that other users cannot make outgoing outside calls from your extension.

Locking

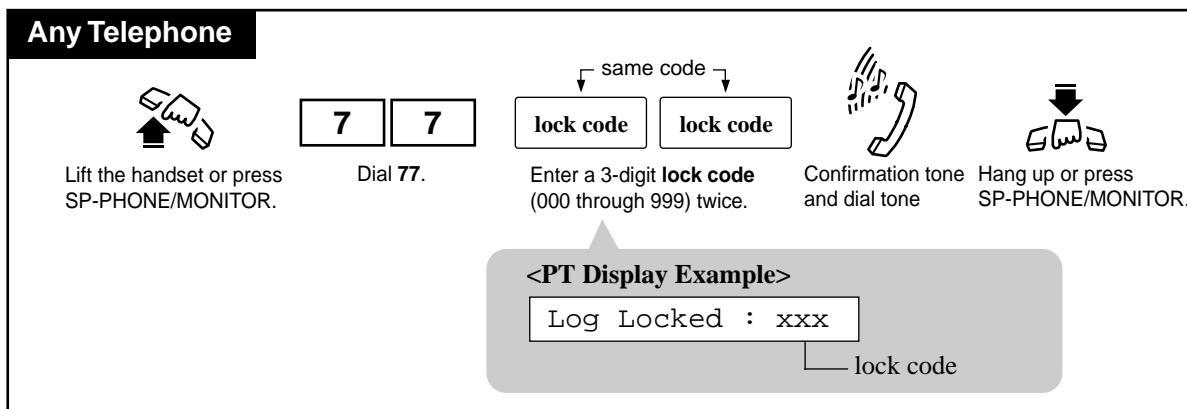

Unlocking

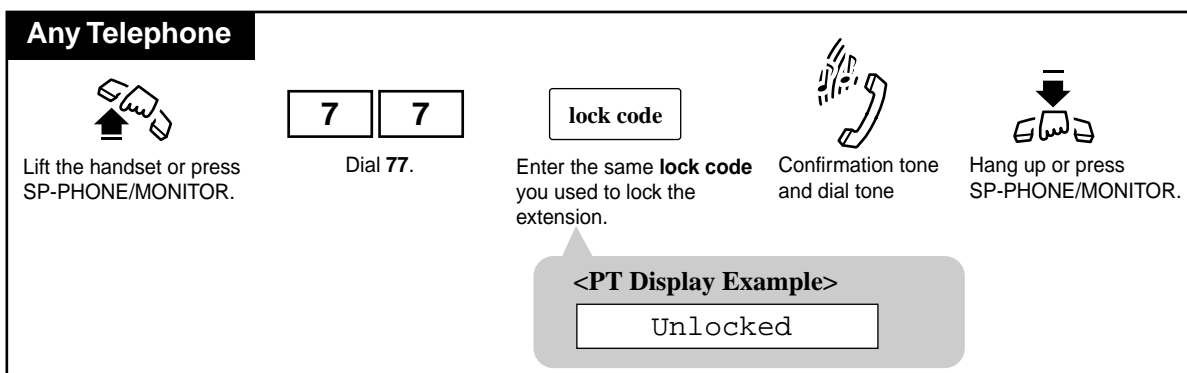

Conditions

- **How does this feature restrict the extension?**
This feature restricts the extension from making an outside call only. Other operations are not affected.
- **Remote Station Lock**
Remote Station Lock Control overrides Electronic Station Lockout. If the Manager or an Operator sets Remote Station Lock on an extension that has already been locked by the extension user, the extension user cannot unlock it.

<PT>

- If someone tries to make an outgoing outside call from a locked extension, he or she hears a reorder tone and "Restricted" is shown on the display.
- With the KX-T7431, KX-T7433, KX-T7436 or KX-T7235, you can execute this feature using the display operation.

<SLT>

- If another user tries to access an outside line from a looked extension, the user hears a reorder tone.
- With the KX-T7431, KX-T7433, KX-T7436 or KX-T7235, you can execute this feature using the display operation.

User Manual References

4.4.7 Remote Station Lock Control

4.5.9 KX-T7235 Display Features - System Feature Access Menu

4.5.12 KX-T7431 / KX-T7433 / KX-T7436 Display Features - System Feature Access Menu

4.3.39 Emergency Call

Allows you to dial out a pre-assigned emergency number after seizing an outside line regardless of the restrictions imposed on your extension. Up to 10 emergency dial numbers can be stored in the system.

Dialing

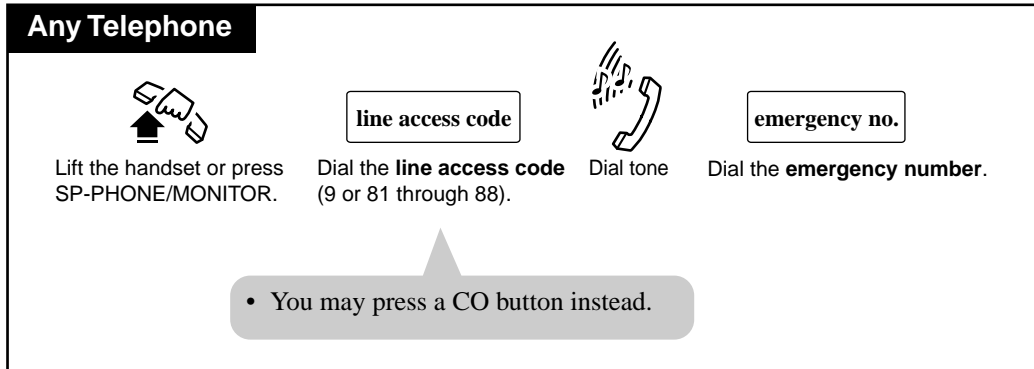

Conditions

- The emergency number "911" is already stored at the factory. System Programming is required to store other emergency numbers.
- An emergency call is allowed even in the following cases;
 - in Account Code – Verified (All Calls, Toll Restriction Override) mode
 - in any toll restriction level
 - in Electronic Station Lockout / Remote Station Lock
- If your telephone is connected to a host PBX, you must dial the host PBX line access code after dialing the line access code and it must be included as the first digit of the emergency no.

Programming Guide References

[334] Emergency Dial Number Set

4.3.40 Executive Busy Override — Extension

You can interrupt an existing extension call (either between two inside parties or between an outside party and an inside party) by dialing "2". This establishes a 3-party conference call.

7230 / 7235 / 7433 / 7436

If you hear a busy tone after making an intercom call;

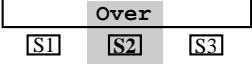

Press **Over (S2)**.



Confirmation tone (optional)

A three-party conference is now established.

Any Telephone

If you hear a busy tone after making an intercom call;



Dial **2**.



Confirmation tone (optional)

A three-party conference is now established.

To leave the conference

Any Telephone



Hang up or press
SP-PHONE/MONITOR.

The other two parties continue their conversation.

To terminate one party and talk to the other

PT

(CO) or INTERCOM

Press the **CO** or **INTERCOM** of the party to remain connected.



Confirmation tone (optional)

Conditions

- **Class of Service**
Class of Service programming determines the extension that can perform this feature.
- This feature does not work when "Data Line Security" or "Executive Busy Override Deny" is set at either or both of the other parties.

- **Executive Busy Override Deny**
It is possible for extension users (if allowed by Class of Service Programming) to prevent this feature from being executed by another extension user.
- **Confirmation tone**
When a 2-party call is changed to a 3-party call and vice versa, a confirmation tone is sent to all three parties. This tone can be eliminated by System Programming.
- **Terminate one party and talk to the other**
This feature can be performed only during conference with an outside party and inside party.

Programming Guide References

- [505] Executive Busy Override
- [601] Class of Service
- [990] System Additional Information



User Manual References

- 4.3.30 Conference
- 4.3.33 Data Line Security
- 4.3.42 Executive Busy Override Deny

4.3.41 Executive Busy Override — Outside Line [PT only]

Allow you to connect to an existing outside call or add a third party to your existing conversation.



Setting

PT		
		
Lift the handset or press SP-PHONE/MONITOR.	Press the red lit CO corresponding to the desired caller.	Confirmation tone (optional)
<u>A three-party conference is now established.</u>		

To leave the conference

PT	
	<u>The other two parties continue their conversation.</u>
Hang up or press SP-PHONE/MONITOR.	

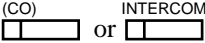
To terminate one party and talk to the other

PT	
	
Press CO or INTERCOM of the party to remain connected.	Confirmation tone (optional)

Conditions

- **Executive Busy Override Deny**
Extension users can prevent this function from being executed by another extension user.
- **Class of Service**
Class of Service programming determines the extension that can perform this feature.
- The pre-assigned extension users can interrupt an existing outside call even if access to that line is not allowed by System Programming.
- This feature does not work if Executive Busy Override Deny or Data Line Security is set at the extension engaged in the existing outside call.
- **Confirmation tone**
When a 2-party call is changed to a 3-party call and vice versa, a confirmation tone is sent to all three parties. This tone can be eliminated by System Programming.

Programming Guide References

[505] Executive Busy Override

[601] Class of Service

[990] System Additional Information

User Manual References

4.3.30 Conference

4.3.33 Data Line Security

4.3.42 Executive Busy Override Deny

4.3.42 Executive Busy Override Deny

Allows you to prevent other extension users from interrupting your telephone conversation.

Any Telephone



Lift the handset or press
SP-PHONE/MONITOR.

7	3	3	1	To set.
7	3	3	0	To cancel.

To set: Dial 7331.
To cancel: Dial 7330.



Confirmation tone
and dial tone

<PT Display Example>

- When setting:

Busy Ovrde Deny
- When canceling:

Busy Ovrde Allow

Conditions

- **Class of Service**
"Class of Service" programming determines the extensions that can perform this feature.
- With the KX-T7431, KX-T7433, KX-T7436 or KX-T7235, you can execute this feature using the display operation.

Programming Guide References

[506] Executive Busy Override Deny

User Manual References

- 4.3.41 Executive Busy Override — Outside Line [PT only]
- 4.3.40 Executive Busy Override — Extension
- 4.5.9 KX-T7235 Display Features - System Feature Access Menu
- 4.5.12 KX-T7431 / KX-T7433 / KX-T7436 Display Features - System Feature Access Menu

4.3.43 External Feature Access

Allows you to access special features (e.g., Call Waiting) offered by a host PBX, Centrex or Central Office. This feature is effective only during an outside call.

You can access the feature by using either the FLASH button or the feature number.

7230 / 7235 / 7433 / 7436

During a conversation with an outside party;

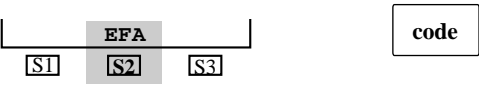

Press **EFA (S2)**. Enter the desired **service code**.

Using the FLASH button

PT

During a conversation with an outside party;



Press **FLASH**. Enter the desired **service code**.

- The current call is placed on hold.

Using the feature number

PT and SLT

During a conversation with an outside party;



For PT: Press **TRANSFER**.
For SLT: Flash the hookswitch.

Dial tone Dial **6**. Enter the desired **service code**.

- The current call is placed on hold.

Conditions

- **Flash Time**

The flash time must be assigned as required by the Centrex, host PBX or outside line.

<PT>

- **Memory Dialing**

During outside calls, a FLASH stored in System Speed Dialing, Station Speed Dialing or One-Touch Dialing works as External Feature Access, not as Flash (Disconnect Signal).

<SLT>

- This feature does not function, if an SLT has a call on Consultation Hold.

Programming Guide References

[413] Flash Time

[990] System Additional Information

User Manual References

4.3.44 Flash [PT only]

4.3.44 Flash [PT only]

You can disconnect the current call and make another call without hanging up.

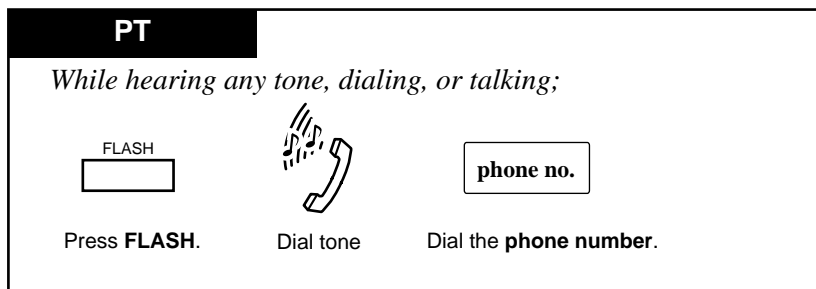

Conditions

- A disconnection signal must be selected by System Programming in order to execute this feature.

Programming Guide References

[414] Disconnect Time

[990] System Additional Information

User Manual References

4.3.43 External Feature Access

4.3.45 Full One-Touch Dialing [PT only]

The hands-free speakerphone is automatically activated. You can enter a phone number or access a system feature with the touch of a button.

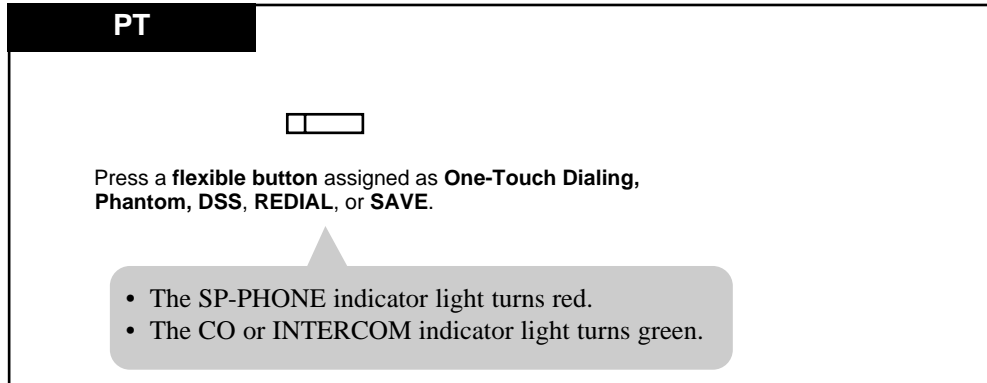

Conditions

- DSS buttons on a DSS Console can also activate this feature.
- This feature must be initially assigned by Station Programming (Full One-Touch Dialing Assignment).

User Manual References

- 2.2.1 Initial Settings
- 2.2.2 Flexible Button Assignment
- 4.3.59 One-Touch Dialing [PT only]
- 4.3.67 Phantom Extension
- 4.3.72 Redial, Last Number
- 4.3.73 Redial, Saved Number [PT only]

4.3.46 Handset Microphone Mute [PT only]

Allow you to turn off the handset microphone so you can consult privately with others in the room. You will still be able to hear the other party. This feature is only available for KX-T7400 series telephone users.

Setting

PT

While on a handset call;

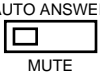

AUTO ANSWER
MUTE

Press **AUTO ANSWER/MUTE**

- The AUTO ANSWER/MUTE indicator light flashes red slowly.

Canceling

PT

When handset microphone mute is established;

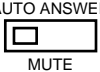

AUTO ANSWER
MUTE

Press **AUTO ANSWER/MUTE**

- The AUTO ANSWER/MUTE indicator light turns off.

Conditions

- This feature is only available during a conversation with the handset.

User Manual References

- 4.3.54 Microphone Mute [PT only]

4.3.47 Hands-free Answerback [PT only]

You can answer an intercom call without lifting the handset.

Setting

PT

When the SP-PHONE and the AUTO ANSWER/MUTE indicator are off;

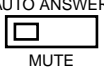

Press **AUTO ANSWER/MUTE**.

- The AUTO ANSWER/MUTE indicator turns on.

Canceling

PT

When the AUTO ANSWER/MUTE indicator is on;

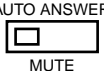

Press **AUTO ANSWER/MUTE**.

- The AUTO ANSWER/MUTE indicator turns off.

Conditions

- **Ring/Voice Intercom Alerting Mode Override**
This feature overrides the "Alternate Calling — Ring/Voice" feature. A hands-free conversation mode is established as soon as a confirmation tone is sent.
- This feature does not work for the following calls:
 - Outside calls
 - Doorphone calls
- When an outside call is transferred to your extension, this feature is overridden and a ringing tone is heard.
- This feature is not available for KX-T7250.

User Manual References

4.3.3 Alternate Calling — Ring / Voice

4.3.48 Hands-free Operation [PT only]

You can answer an intercom call without lifting the handset.

Setting

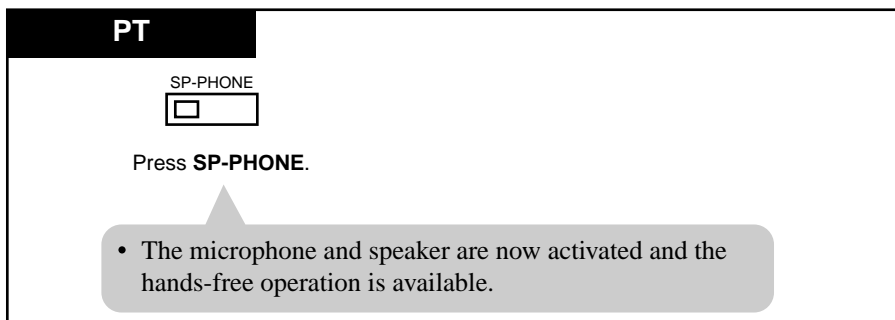

Switching from the handset to hands-free mode

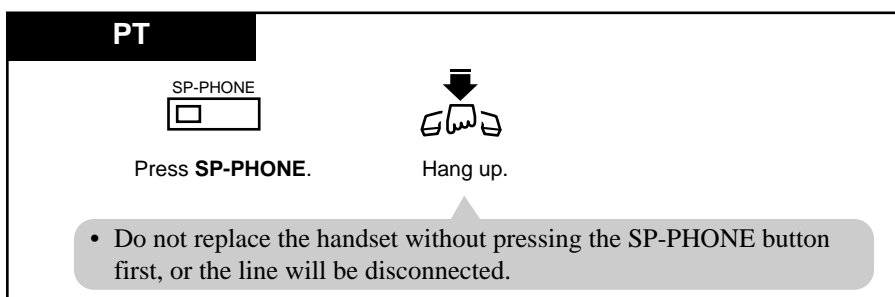

Switching from hands-free to the handset mode



Conditions

- The hands-free mode is canceled if you do not start dialing within 10 seconds.
- The KX-T7250 have a MONITOR button instead of a SP-PHONE button. It can be used for hands-free dialing, etc., but not for a hands-free conversation.
- You can enable hands-free mode by pressing a CO or INTERCOM button without going off-hook.
- When "Full One-Touch Dialing" is enabled, pressing a One-Touch Dialing, DSS, Phantom, REDIAL or SAVE button provides the hands-free mode.

Helpful hints

- Use this unit in a quiet room for best performance.
- If the other party has difficulty hearing you, decrease the volume.
- If you and the other party speak at the same time, parts of your conversation will be lost. To avoid this, speak alternately.

User Manual References

4.3.45 Full One-Touch Dialing [PT only]

4.3.49 Intercom Calling

You can make a call to another extension user within the system or a tenant.

Using the handset

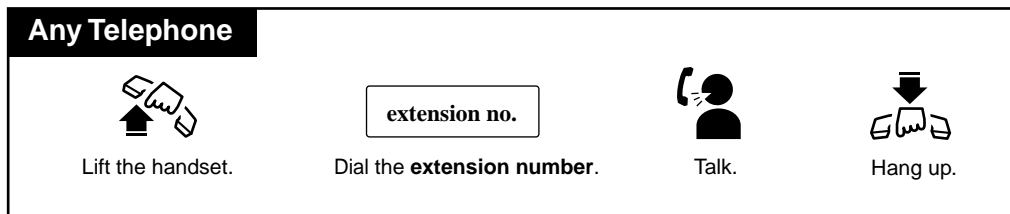

Using the Speakerphone

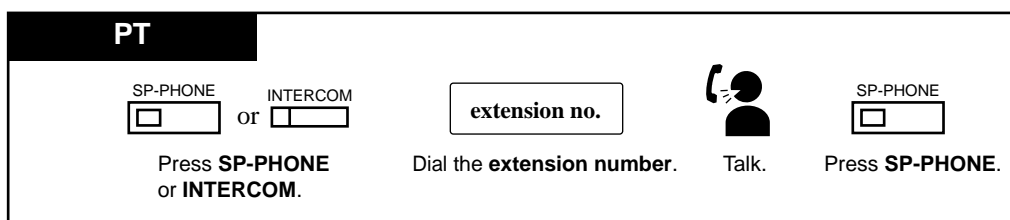

Using a DSS (Direct Station Selection) button

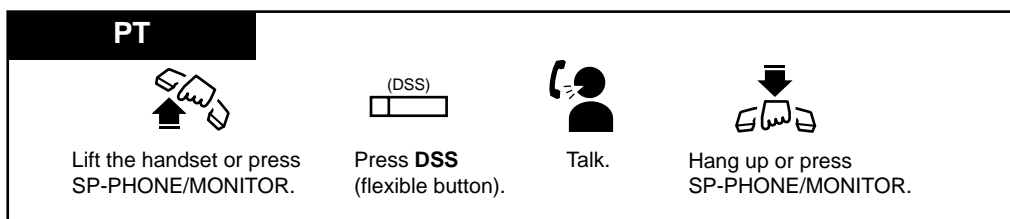

Conditions

- **Extension Number Assignment**
Extension numbers are assigned to all extensions according to [003] Extension Number Set in the Programming Guide.
- **Call Progress Tone**
After dialing an extension number, you will hear one of the following tones:
Ringback tone: Indicates the destination extension is being called.
Confirmation tone: Indicates you can perform voice calling (e.g., Paging).
Busy tone: Indicates the destination extension is busy.
Do Not Disturb (DND) tone: Indicates the destination extension has set the "Do Not Disturb (DND)" feature.

<PT>

- You can assign a DSS button on a proprietary telephone (PT) or DSS Console by Station, User or System Programming.
- Extension names can be given to all extensions by User or System Programming. An extension number and a name, if programmed, are shown on the display PT during an intercom call.

- **Call Directory - Extension Dialing**

With the KX-T7431, KX-T7433, KX-T7436, or KX-T7235, you can make an extension call using the "Call Directory - Extension Dialing" display operation.

Programming Guide References

[003] Extension Number Set

[004] Extension Name Set

[012] ISDN Extension Number Set

[013] ISDN Extension Name Set

User Manual References

2.2.2 Flexible Button Assignment

3.2.4 [003] Extension Number Set

3.2.5 [004] Extension Name Set

4.5.8 KX-T7235 Display Features - Call Directory

4.5.11 KX-T7431 / KX-T7433 / KX-T7436 Display Features - Call Directory

4.3.50 Live Call Screening (LCS) [PT only]*¹

When you have set a Voice Mail extension as the Call Forwarding destination and have activated the LCS feature, you can monitor a message while a caller is leaving the message in your mailbox. If desired, you can answer the call while monitoring. There are two methods available. In both modes, if you are currently having a conversation, you will hear a Call Waiting tone.

Hands-free mode: You can monitor a message automatically through the telephone speaker at the same time.

Private mode: You will hear an alert tone while the caller is leaving a message.

Preparation

- Activating the LCS mode (System Programming)
- Assigning the LCS button (Station/System Programming)
- Selecting the mode, Hands-free or Private (Station Programming)
- Setting the Password (Feature Number/System Programming)
- Setting the LCS feature

*¹ Available when the Digital Super Hybrid System is connected to a Digital Proprietary Telephone capable Panasonic Voice Processing System (one that supports digital proprietary telephone integration; e.g., KX-TVS100).

Flowchart of the Live Call Screening (LCS) Feature

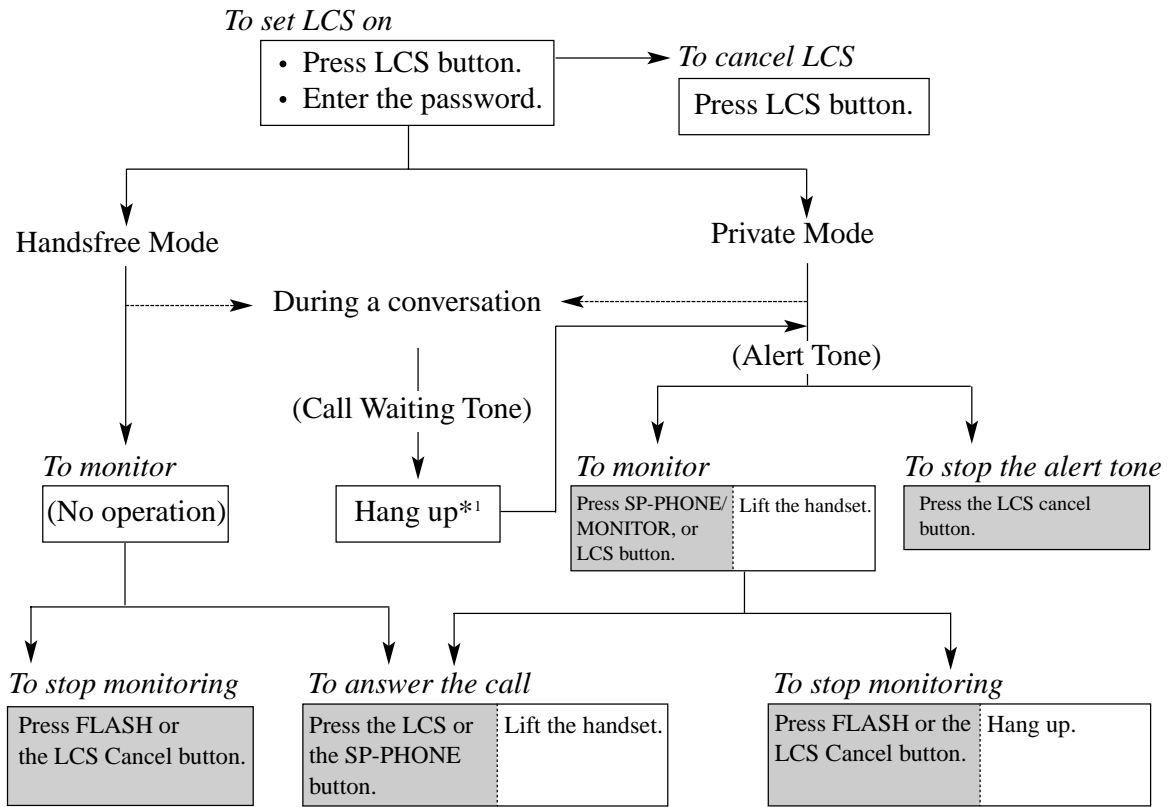

- *1: To hold the current call, press the HOLD button.
To return to the held call, press the CO button whose indicator light flashes green slowly.
- The shaded areas are for the Handsfree operation.

Setting the password

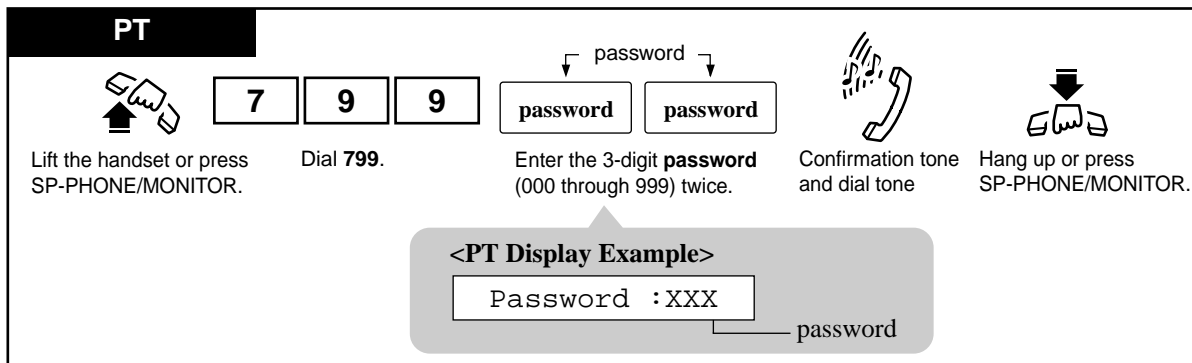

Note

In order to change the password, cancel the current password and then set a new password.

Canceling the password

PT

Lift the handset or press SP-PHONE/MONITOR.

Dial **799**.

Enter the same **password** you used to set.

Confirmation tone and dial tone

Hang up or press SP-PHONE/MONITOR.

<PT Display Example>
Password Cancel

Setting Live Call Screening

PT

When the telephone is idle and on-hook;

(LCS)
Press **LCS** (flexible button).

—In the Hands-free mode;
<PT Display Example>
Live Call Screen

—In the Private mode;
<PT Display Example>

- If a caller ID call is received at your extension, the display will show the caller's telephone number:
1 2 3 4 5 6 7
- In all other cases, the display will show:
Live Call Screen

password
Enter the **password**.

- The LCS indicator light turns on.

Canceling Live Call Screening

PT

When the telephone is idle and on-hook;

(LCS)
Press **LCS** (flexible button).

- The LCS indicator light turns off.

In the Hands-free mode:

When callers are connected to your voice mailbox, the message recording is monitored automatically through your extension speaker. While monitoring in the Hands-free mode, the LCS indicator light flashes green slowly.

Having a conversation with a party

PT



Lift the handset or press SP-PHONE.



or  (LCS)

Press **LCS** (flexible button).

- The LCS indicator light turns red from flashing green slowly.
- In Keep Recording mode, the Two-Way Record indicator turns on. Pressing the Two-Way Record button cancel the recording and the light turns off.

Stopping the monitoring

PT

 FLASH or  (LCS Cancel)

Press **FLASH** or **LCS Cancel** (flexible button).



- The LCS indicator light turns red from flashing green slowly.

In the Private mode:

When callers are connected to your voice mailbox, an alert tone is sent. The LCS indicator light flashes green rapidly when a caller is connected to your voice mailbox. (When using a single line telephone, which is connected with a proprietary telephone in parallel, you hear ringing.)

Stopping the alert tone

PT



 FLASH or  (LCS Cancel)

Press **FLASH** or **Live Call Screening Cancel** button.

- The LCS indicator light turns red from flashing green rapidly
- The alert tone stops.

Monitoring the recording message

PT



 or
 
 or
 

Lift the handset or press SP-PHONE/MONITOR. Press the flashing **LCS** (flexible button). Press **INTERCOM**.

- The LCS indicator light flashes green slowly.
- To stop monitoring, lift the **handset**.
The **FLASH** button or the **LCS Cancel** button can also be used to stop monitoring.
The LCS indicator light turns red from flashing green slowly.

Having a conversation with a party

PT

 or
 

Lift the handset or press SP-PHONE. Press the flashing **LCS** (flexible button).

- The LCS indicator light turns red from flashing green slowly.
- In Keep Recording mode, the Two-Way Record indicator lights.

During a conversation with another party:

When the extension user is having a conversation, a call waiting tone is sent. The LCS indicator light flashes green rapidly.

- If you want to terminate the current call

Monitoring

PT

 Hang up or press SP-PHONE/MONITOR.

- An alarm tone is sent.

 Lift the handset or press SP-PHONE/MONITOR.

- Monitoring Starts.

Having a conversation with a party

PT

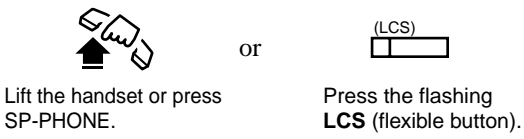

Lift the handset or press SP-PHONE.

OR

Press the flashing **LCS** (flexible button).

- If you want to hold the current call

Monitoring

PT



HOLD
Press **HOLD**.

Hang up or press SP-PHONE/MONITOR.

Lift the handset or press SP-PHONE/MONITOR.

- An alarm tone is sent.
- Monitoring Starts.

Having a conversation with the party

PT

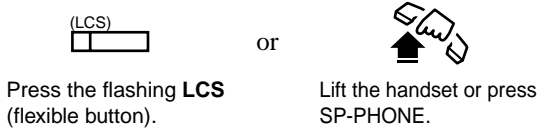

Press the flashing **LCS** (flexible button).

OR

Lift the handset or press SP-PHONE.

Conditions

- The LCS indicator shows the feature status as follows.
 - Red (steady) : The Live Call Screening mode is on.
 - Off : The Live Call Screening mode is off.
 - Flashing green slowly : Live Call Screening is acting.*1
 - Flashing green rapidly : Alarm tone is ringing in the Private mode.*1
- The Two-Way Record indicator shows the feature status as follows.
 - On : Recording the conversation
 - Off : Not recording

*1 The DSS button indicator lights red steady while Live Call Screening is active.

- During Keep Recording mode, if you want to stop recording the conversation, press the Two-Way Recording button.
- An incoming call via a voice mail service can be monitored by the LCS feature while the caller is leaving a message in your mailbox even when you have not set a Voice Mail extension as the Call Forwarding destination.
- **Call Waiting**
If the extension user is busy on a call when a caller begins to leave a message, a call waiting tone is sent (if programmed beforehand). The extension user can put the current call on hold before accessing LCS.
- **LCS button/LCS Cancel button**
A flexible CO and DSS button can be assigned as an LCS/LCS Cancel button.
- **LCS Password Clear**
To prevent unauthorized monitoring, a 3-digit password must be set by the extension user. If the user forgets their password, it can be cleared by the Manager extension or an Operator.

Programming Guide References

[610] Live Call Screening Recording Mode Assignment

User Manual References

2.2.1 Initial Settings

2.2.2 Flexible Button Assignment

4.4.5 Live Call Screening Password Control

4.5.9 KX-T7235 Display Features - System Feature Access Menu

4.5.12 KX-T7431 / KX-T7433 / KX-T7436 Display Features - System Feature Access Menu

4.3.51 Lockout

If one party in a conversation goes on-hook, they both are disconnected from the speech path automatically. A reorder tone is sent to the off-hook party before it is disconnected. No operation is necessary.

4.3.52 Log-In / Log-Out

Allows you to assign the Log-In mode or Log-Out mode within a hunting, ring or UCD (Uniform Call Distribution) group. When in the Log-Out mode, you can leave the group temporarily, preventing hunting calls from being sent to your extension. The lightning patterns of the Log-In / Log-Out button and status are as follows.

Off : Log-In mode

Red : Log-Out mode

Flashing red moderately : Calls are waiting in the UCD queue

Log-In / Log-Out (Using the Log-In / Log-Out button)

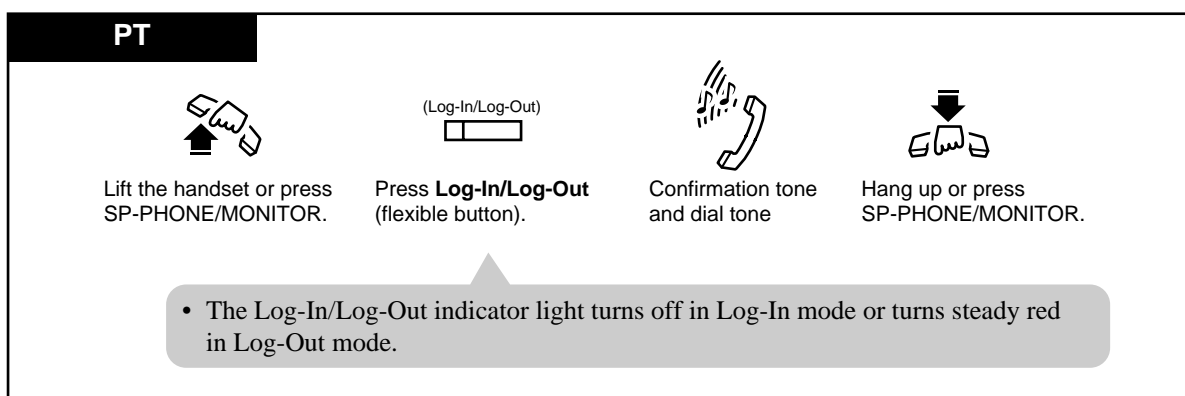

Log-In / Log-Out (Using the feature number)

PT and SLT



Lift the handset
or press
SP-PHONE/MONITOR.

4	5	1	To Log-In.
4	5	0	To Log-Out.

For Log-In mode: Dial **451**.
For Log-Out mode: Dial **450**.



Confirmation tone
and dial tone



Hang up or press
SP-PHONE/MONITOR.

<PT Display Example>

Log-in

or

Log-out

Conditions

- By default, all extensions in the group are in "Log-In" mode.
- When extensions are logged out, calls directed to the above mentioned group do not come in on their extension.
However, calls directed to their individual extension (extension call, DIL 1:1, DIL 1:N, etc.) still ring at their extension.

<PT>

- **Log-In/Log-Out button**
The Log-In / Log-Out button can be assigned to a flexible CO button.
- With the KX-T7431, KX-T7433, KX-T7436 or KX-T7235, you can execute this feature using a display operation.

<ISDN Telephone>

- This feature is not available for ISDN telephones.

Features Guide References

Station Hunting
Ring Group
Uniform Call Distribution (UCD)

User Manual References

2.2.2 Flexible Button Assignment
4.3.84 Uniform Call Distribution (UCD)
4.5.9 KX-T7235 Display Features - System Feature Access Menu
4.5.12 KX-T7431 / KX-T7433 / KX-T7436 Display Features - System Feature Access Menu

4.3.53 Message Waiting

When the called extension or phantom extension is busy or does not answer your call, you can leave a notification so that the called party may call you back.

As a message receiver, the MESSAGE button light and an indication tone which you will hear when going off-hook let you know that a call has been received. If you receive notification, you can call back the original party with a simple operation. If required, you can assign a Flexible (CO, DSS) button as Another Extension Message Waiting button or the Phantom Message Waiting button by program "[005] Flexible CO Button Assignment". For details, consult your dealer or manager.

Setting

PT and SLT



Lift the handset or press
SP-PHONE/MONITOR.

7

0

1

Dial **701**.

extension no.

or

phantom extension no.

Dial the **extension number** or the **phantom extension number** where you left a message notification.



Confirmation
tone and
dial tone



Hang up or press
SP-PHONE/MONITOR.

PT

If the called extension or phantom extension is busy or does not answer;

MESSAGE

Press **MESSAGE**.



Confirmation tone
and dial tone



Hang up or press
SP-PHONE/MONITOR.

Canceling

PT and SLT



Lift the handset or press SP-PHONE/MONITOR.

7

0

0

Dial **700**.

extension no.

or

phantom extension no.

Dial the **extension number** or the **phantom extension number** where you left a message notification.



Confirmation tone and dial tone.



Hang up or press SP-PHONE/MONITOR.

Checking and Selecting a message notification by the receiver

Display PT

If there is any message notification, the message waiting lamp, another extension message waiting lamp or phantom extension message waiting lamp (MESSAGE indicator) light will be on. When the telephone is idle and on-hook;

MESSAGE

or

MESSAGE

or

MESSAGE

(Another Extension
Message Waiting)

(Phantom Extension
Message Waiting)

Press **MESSAGE** button, **Another Extension Message Waiting** button or the **Phantom Extension Message Waiting** button repeatedly until the desired message appears.

- The message notifications you received are shown on the display in the order they were received.

<PT Display Example>
When Tony at extension 123 left a message notification:

123 : Tony

Calling back the message notification sender

PT



Lift the handset or press SP-PHONE/MONITOR.



Dial tone 4*, when a message has been received at your extension.

MESSAGE

or

MESSAGE

or

MESSAGE

(Another Extension
Message Waiting)

(Phantom Extension
Message Waiting)

Press **MESSAGE** button, **Another Extension Message Waiting** button or the **Phantom Extension Message Waiting** button.



Talk.

- If there are more than one message notification left on your extension, you can choose the desired message sender (display PT only).

- The message notification is cleared after the conversation.

* One of the dial tones. Refer to the "Tone List" in the Appendix (Section 6).

PT and SLT

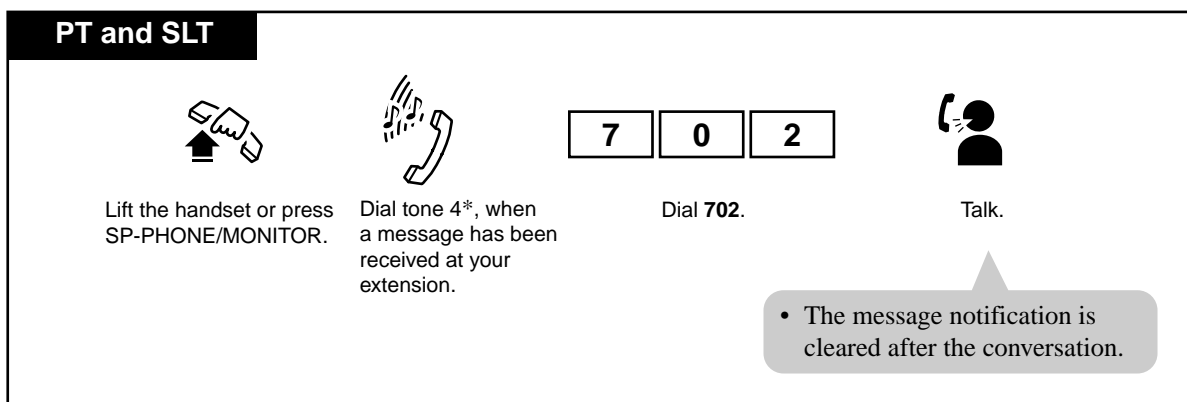

Lift the handset or press SP-PHONE/MONITOR.

Dial tone 4*, when a message has been received at your extension.

Dial **702**.

Talk.

- The message notification is cleared after the conversation.

* One of the dial tones. Refer to the "Tone List" in the Appendix (Section 6).

Clearing all message notifications left on your extension

PT and SLT with Message Lamp

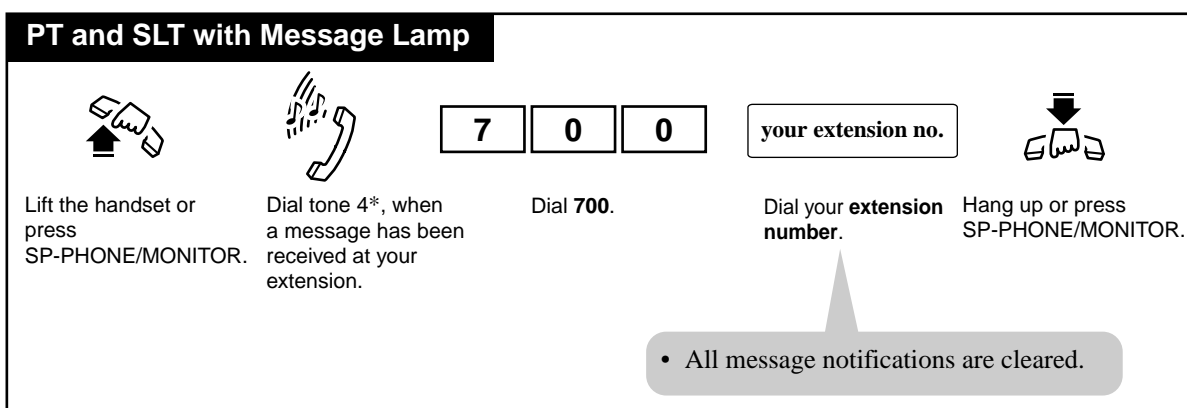

Lift the handset or press SP-PHONE/MONITOR.

Dial tone 4*, when a message has been received at your extension.

Dial **700**.

Dial your **extension number**.

Hang up or press SP-PHONE/MONITOR.

- All message notifications are cleared.

* One of the dial tones. Refer to the "Tone List" in the Appendix (Section 6).

Conditions

- The system supports a maximum of 128 simultaneous messages. Except these, up to 128 phantom messages can be recorded. If you try to set the 129th message, you will hear a reorder tone.
- Callback Order**
If multiple message notifications are left at your extension, callback is executed in the order received.
- If you select a specific message to call back, callback is executed in the order received, starting with the one selected.
- VPS Integration**
If VPS Integration is employed, a VM extension informs an extension that a message is left in his/her mailbox by turning on the MESSAGE lamp.
The extension user can listen to the message in the mailbox simply by pressing the red lit MESSAGE lamp.

- Even if the MESSAGE buttons are neither provided nor assigned, dial tone 4*¹ after going off-hook informs you if a message has been received at your extension. For standard telephone users, a special ring tone can be provided as notification.
- With the KX-T7431, KX-T7433, KX-T7436 or KX-T7235, you can set or cancel this feature using the display operation.

<7250>

- A flexible button on the KX-T7250 (no MESSAGE button provided) can be assigned as the MESSAGE buttons.

<SLT>

- Single line telephone users with a message waiting lamp can activate the lamp in the same way as a MESSAGE button on the proprietary telephone by connecting a SLT Message Waiting Lamp Adaptor Unit (KX-TD194) to the system. The message waiting lamp lighting pattern can be selected from twelve patterns. System Programming is required to use this feature.

<ISDN Telephone>

- This feature is not available for ISDN telephones.

Programming Guide References

- [005] Flexible CO Button Assignment
- [130] Message Waiting Control
- [131] Message Waiting Lamp Assignment
- [132] Message Waiting Port Set
- [216] Message Waiting Ring Interval Time
- [990] System Additional Information

User Manual References

- 2.2.2 Flexible Button Assignment
- 4.5.9 KX-T7235 Display Features - System Feature Access Menu
- 4.5.12 KX-T7431 / KX-T7433 / KX-T7436 Display Features - System Feature Access Menu

^{*1} One of the dial tones. Refer to the "Tone List" in the Appendix (Section 6).

4.3.54 Microphone Mute [PT only]

During a conversation in the hands-free mode, you can turn off your PT's microphone so that you can consult privately with others in the room. When you activate Microphone Mute, you can still listen to your caller's voice but your caller cannot hear your voice.

Setting

PT

During a conversation in the hands-free mode;

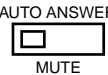

AUTO ANSWER
MUTE

Press **AUTO ANSWER/MUTE**.

- The AUTO ANSWER/MUTE indicator light flashes red slowly.

Canceling

PT

When microphone mute is established;

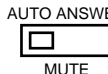

AUTO ANSWER
MUTE

Press **AUTO ANSWER/MUTE**.

- The AUTO ANSWER/MUTE indicator light turns off.

Conditions

- This feature is only available during a hands-free conversation.
- This feature is not available for KX-T7250.

4.3.55 Night / Day (Lunch / Break) Service

This system supports both the night and day modes of operation. The day mode includes the lunch and break modes. The system operation for originating and receiving calls can be changed depending on the mode. You can transfer received outside calls to assigned extension groups while in the lunch or break mode. Toll restriction calls can be programmed to prevent unauthorized toll calls at night. The Day/Lunch/Break/Night modes can be switched manually at any desired time by a pre-assigned extension user, operator or manager. The operator or manager can perform the operation using the display.

If the Night button is assigned, its lighting patterns and status are as follows.

Off: Day/Lunch/Break mode

Red: Night mode

Switching the mode (Display operation)

7235 / 7436



Features

Press **Features**.

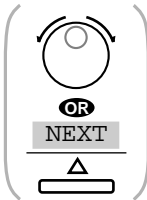

Rotate **Jog Dial** or press **NEXT** until the following is displayed.



Night On/Off (→0-3)

Press **Night On / Off** button.

0	Day Mode
1	Night Mode
2	Lunch Mode
3	Break Mode

Enter the desired **mode number (0 to 3)**.



Confirmation tone



Hang up or press **SP-PHONE**.

- The display shows the current mode.

Switching the mode (Display operation)

7431



Press **MODE** until "**Feature Access**" is displayed.



Rotate **Jog Dial** until "**Night Mode**" is displayed.



Press **SELECT**.

0	Day Mode
1	Night Mode
2	Lunch Mode
3	Break Mode

Enter the desired **mode number (0 to 3)**.



Confirmation tone



Hang up or press SP-PHONE.

- The display shows the current mode.

Switching Day/Night mode (Display operation)

7433



Press **SHIFT** until "**FEAT**" is displayed.



Press **FEAT**.



Rotate **Jog Dial** until "**Night Mode**" is at the arrow.

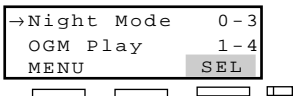

Press **SEL**.

0	Day Mode
1	Night Mode
2	Lunch Mode
3	Break Mode

Enter the desired **mode number (0 to 3)**.



Confirmation tone



Hang up or press SP-PHONE.

- The display shows the current mode.

Switching Day/Night mode (Night button operation)

PT



Lift the handset or press SP-PHONE/MONITOR.



Press Night (flexible button).



Confirmation tone and dial tone



Hang up or press SP-PHONE/MONITOR.

- The status of Night indicator.

Day mode	Off
Night mode	On (Red)
- The display shows the current mode.

Switching Day/Night modes (Feature number operation)

Any Telephone



Lift the handset or press SP-PHONE/MONITOR.

7

8

Dial 78.

0	Day Mode
1	Night Mode
2	Lunch Mode
3	Break Mode



Confirmation tone



Hang up or press SP-PHONE/MONITOR.

Enter the desired **mode number (0 to 3)**.

- The display shows the current mode.

Confirming the current mode

Display PT

When the telephone is idle;

#

Press #.

- The display shows the current mode for three seconds.

Conditions

- The following items have separate day and night programming.
 - a) Outgoing Permitted Outside Line Assignment
 - b) Direct In Lines (DIL)
 - c) Doorphone Ringing Assignment
 - d) Extension Ringing Assignment
 - e) Ringing, Delayed
 - f) Toll Restriction Level
 - g) Direct Inward Dialing (DID)
 - h) Intercept Routing
 - i) Outgoing Permitted Outside Line Assignment for ISDN Extension
 - In the lunch/break mode, only the DIL 1:1 destination of [457-458] is effective; if it is not assigned, DIL 1:1 (Day)/DIL 1:N (Day) perform in the day mode as usual. Using feature numbers, you can go from day mode to any other mode. However, from night mode, you can only go to day mode.
 - **Class of Service**
Class of Service programming determines the extensions that can perform this feature.
 - The Day/Lunch/Break/Night mode is automatically switched at a predetermined time (default: 9:00 a.m. for all days of the week; 12:00 p.m – 12:59 p.m for lunch; 3:00 p.m – 3:29 p.m for break; 5:00 p.m. for all nights of the week) if automatic switching mode is selected in System Programming.
- <PT>
- A flexible CO and DSS button can be assigned as the Night button.

Programming Guide References

- [101] Day / Night Service Switching Mode
- [102] Day / Night Service Starting Time
- [150] Lunch Service Starting / Ending Time
- [151] Break Service Starting / Ending Time
- [457-458] DIL 1:1 — Lunch / Break Group
- [510] Night Service Access
- [620] Lunch / Break Group Assignment

Features Guide References

- Direct Inward Dialing (DID)
- Direct In Lines (DIL)
- Intercept Routing
- Lunch / Break Service
- Night Service
- Outside Line Connection Assignment — Outgoing

Ringing, Delayed

Toll Restriction

Integrated Services Digital Network (ISDN)

User Manual Reference

2.2.2 Flexible Button Assignment

4.3.37 Doorphone Call

4.5.9 KX-T7235 Display Features - System Feature Access Menu

4.5.12 KX-T7431 / KX-T7433 / KX-T7436 Display Features - System Feature Access Menu

4.3.56 Off-Hook Call Announcement (OHCA)

Allows you to signal a busy extension on a handset call that your call is waiting. Your voice is heard through the built-in speaker of the called party's PT (KX-T7235 or KX-T7436). The called extension user can select to talk to you or their initial caller.

Setting

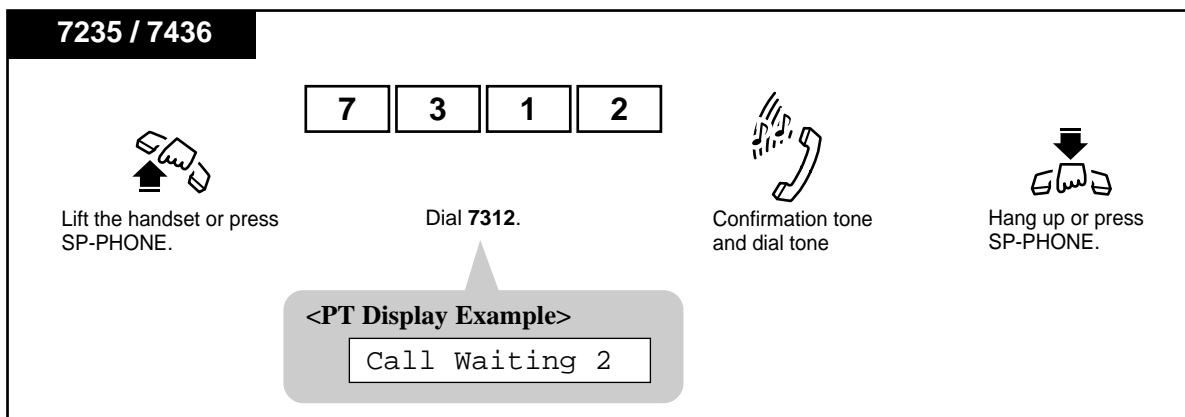

Canceling

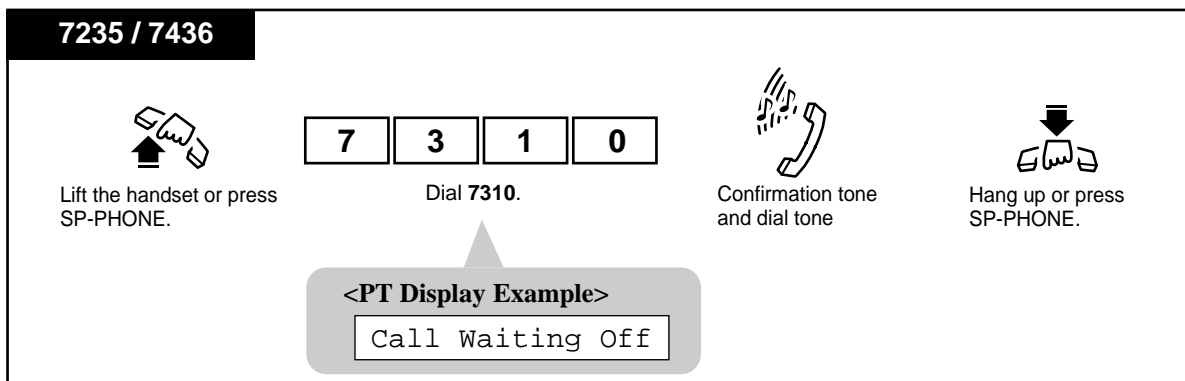

Executing

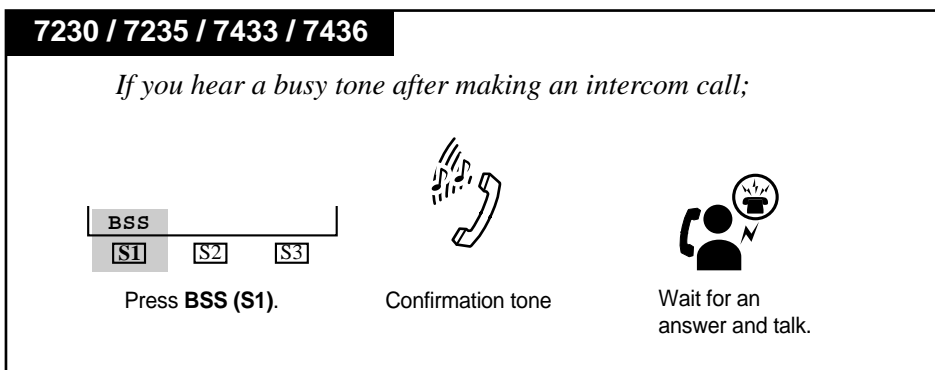

Executing

Any Telephone

If you hear a busy tone after making an intercom call;

1

Dial 1.



Confirmation tone



Wait for an answer and talk.

To talk to the third party

7235 / 7436

If OHCA is activated by the other party when you are engaged in a call using the handset, you hear a confirmation tone and then the caller's voice through the built-in speaker of your PT.



Speak with the third party through microphone.

- The caller's number or name is shown on the display for five seconds in 10 seconds intervals.

<PT Display Example>

123: Tony

————— Caller's extension number

- You can talk to two parties individually.

To talk to the third party by terminating the current call in hands-free mode

7235 / 7436

If OHCA is activated by the other party when you are engaged in a call using the handset, you hear a confirmation tone and then the caller's voice through the built-in speaker of your PT.



Hang up or press
SP-PHONE.

- The current call is disconnected.
- The INTERCOM indicator light turns green.



Speak with the third
party through microphone.

- You can talk in hands-free mode.

To talk to the third party after placing the current call on hold

7235 / 7436

If OHCA is activated by the other party when you are engaged in a call using the handset, you hear a confirmation tone and then the caller's voice through the built-in speaker of your PT.

HOLD



Press **HOLD**.



Talk.

- The current call is placed on hold.
- The INTERCOM indicator light flashes green slowly.

Conditions

- **BSS / OHCA / Whisper OHCA**

If an extension user dials "1" while hearing a busy tone, BSS or OHCA or Whisper OHCA will be activated at the called extension.

This is determined by the following conditions.

Calling extension	Called extension			
COS-OHCA assignment	Call Waiting setting			
	OFF	ON		
	0	1	2	3
Disable	—	BSS	BSS	BSS
Enable	—	BSS	OHCA*1 →BSS	W-OHCA*2 →OHCA →BSS

*1 OHCA (Off-Hook Call Announcement) is activated when the called extension is KX-T7235 or KX-T7436.

*2 Whisper OHCA is activated when both calling and called extensions are using one of the KX-T7400 series PT.

- If "Do Not Disturb (DND)" feature is set at the called extension, you hear DND tone. In this case, to execute OHCA, you must first activate "Do Not Disturb (DND) Override" feature before OHCA is available.

- **Call Waiting**

This feature is only effective if the called extension has set "Call Waiting" feature. If not, you will hear a reorder tone after dialing 1.

<PT>

- This feature works when the other extension is in off-hook status and the INTERCOM button is idle/lit in green.

Programming Guide References

[509] Off-Hook Call Announcement (OHCA)

User Manual References

4.3.7 Busy Station Signaling (BSS)

4.3.27 Call Waiting

4.3.57 Off-Hook Call Announcement (OHCA) —Whisper [PT only]

4.3.57 Off-Hook Call Announcement (OHCA) — Whisper [PT only]

This is a version of the OHCA feature. The difference is, OHCA provides two-way communication between two extensions but this feature provides one-way communication. When this feature is activated, the called party can hear caller's voice through the handset but the caller cannot hear the called party's voice.

By default, this feature is available only when both calling and called extensions are using KX-T7400 series PTs.

Setting

74XX



Lift the handset or press SP-PHONE.

7	3	1	3
---	---	---	---

Dial 7313.



Confirmation tone and dial tone



Hang up or press SP-PHONE.

<PT Display Example>

Call Waiting 3

Canceling

74XX



Lift the handset or press SP-PHONE.

7	3	1	0
---	---	---	---

Dial 7310.



Confirmation tone and dial tone



Hang up or press SP-PHONE.

<PT Display Example>

Call Waiting Off

Executing

7433 / 7436

If you hear a busy tone after making an intercom call;

BSS		
S1	S2	S3

Press **BSS (S1)**.



Confirmation tone



Wait for an answer and talk.

Executing

74XX

If you hear a busy tone after making an intercom call;



Dial 1.



Confirmation tone



Wait for an answer and talk.

Receiving a voice announcement

74XX

If Whisper OHCA is activated by the other party when you are engaged in a call, you hear a confirmation tone. Then you will be engaged in both calls with the current caller (two-way) and the third party (one-way).

<PT Display Example>
 The caller's extension number or name is shown on the display for five seconds in 10 seconds intervals.

123 : Tony

— Caller's extension number

To talk to the third party by terminating the current call in hands-free mode

74XX

If Whisper OHCA is activated by the other party when you are engaged in a call, you hear a confirmation tone. Then you will be engaged in both calls with the current caller (two-way) and the third party (one-way).



Hang up.

- The current call is disconnected.
- The INTERCOM indicator light turns green.

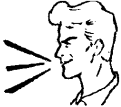

Speak with the third party through microphone.

- You can talk in hands-free mode.

To talk to the third party after placing the current call on hold

74XX

If Whisper OHCA is activated by the other party when you are engaged in a call, you hear a confirmation tone. Then you will be engaged in both calls with the current caller (two-way) and the third party (one-way).



Press **HOLD**.



Talk.

- The current call is placed on hold.
- The INTERCOM indicator light flashes green slowly.

Conditions

- This feature can be enabled to any PTs (other than KX-T7400 series PT) by System Programming.
- If the Whisper OHCA sender does not use a KX-T7400 series telephone, Whisper OHCA works as OHCA. If the receiver does not use a KX-T7400 series telephone, Whisper OHCA may not work properly. (e.g., the announcement may be heard by the other party.)
- Class of Service programming determines which extension can perform Whisper OHCA.
- The Whisper OHCA receiving extension display shows the calling extension's number or name for 5 seconds in 10 second intervals.
- You can select to receive a Call Waiting tone, OHCA, Whisper OHCA or none of these at your extension.
- The receiving mode may shift depending on the setting on each telephone or the telephone type.
 - <Example> If the user selects 3 (Whisper OHCA mode);
 - If using a KX-TD7436 handset: Whisper OHCA
 - If using a KX-TD7436 SP-PHONE: Call Waiting
 - Other: Call Waiting
- The Whisper OHCA sender will receive a ringback tone in the following cases.
 - If the receiver presses the TRANSFER, CONF, SP-PHONE, DSS or CO button.
 - If the party who is talking with the receiver disconnects the line or presses the TRANSFER, CONF or HOLD button.

Programming Guide References

[509] Off-Hook Call Announcement (OHCA)

User Manual References

4.3.7 Busy Station Signaling (BSS)

4.3.27 Call Waiting

4.3.56 Off-Hook Call Announcement (OHCA)

4.3.58 Off-Hook Monitor [PT only]

While you are on a handset call, your call can be monitored by the others in the room through SP-PHONE.

This feature is only available for the KX-T7431, KX-T7433 and KX-T7436 telephone users.

Setting

PT

While on a handset call;

SP-PHONE



Press **SP-PHONE**.

- The SP-PHONE indicator light turns red.
- Your handset call is heard through the SP-PHONE.

Switching from off-hook monitor to handset call

PT

While in the off-hook monitor mode;

SP-PHONE



Press **SP-PHONE**.

- The SP-PHONE indicator light turns off.
- Off-hook monitor mode is canceled and handset call mode is established.

Switching from off-hook monitor to hands-free mode

PT

While in the off-hook monitor mode;

 Hang up.

- Off-hook monitor mode is canceled and hands-free mode is established.

Conditions

- Making an OHCA call is not available if the other extension is in Off-Hook Monitor mode.
- This feature is only available during a conversation with the handset.

Programming Guide References

[148] Off-Hook Monitor

User Manual References

4.3.48 Hands-free Operation [PT only]

4.3.59 One-Touch Dialing [PT only]

Allows you to make a call (intercom or outside) or access a system feature with the touch of a button. This is done by storing an extension number, telephone number or feature number (up to 16 digits) in a One-Touch Dialing button.

Dialing

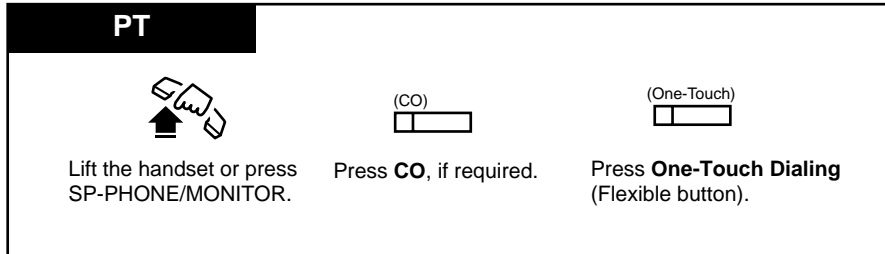

Conditions

- One-Touch Dialing button can be programmed by Station, User or System Programming.
- If you store the telephone number of an outside party, a line access code (9, or 81 through 88) must be stored as the leading digit.
- You may press a CO button to select a desired outside line directly before pressing the One-Touch Dialing button.
- **Combination dialing**
Speed Dialing, One-Touch Dialing, manual dialing, Last Number Redial and Saved Number Redial can be used in a combination.
- **Storing more than 17 digits number**
It is possible to store a number consisting of 17 digits or more by dividing it and storing it in two One-Touch Dialing buttons. In this case, an outside line access code should be stored in the first button.
- **Full One-Touch Dialing**
If "Full One-Touch Dialing" is enabled by Station Programming, you can press the One-Touch Dialing button directly without going off-hook.

User Manual References

- 2.2.2 Flexible Button Assignment
- 4.3.45 Full One-Touch Dialing [PT only]

4.3.60 Operator Call

Allows you to call an operator within the system. Two extensions can be assigned as Operator 1 and 2.

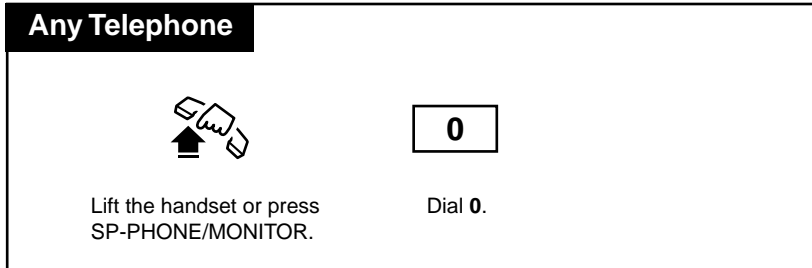

Conditions

- If no operator is assigned, this feature is not available and you will hear a reorder tone after dialing the feature number.
- The call is routed to Operator 1 first. If Operator 1 is busy, then it is routed to Operator 2. Through System Programming, it is possible to change the routing so that Operator 1 and Operator 2 are called simultaneously when the operator is called.

Programming Guide References

[990] System Additional Information

4.3.61 Outward Dialing, Line Access — SUMMARY

A CO line can be accessed in the following ways.

<PT users>

Line Access, Automatic	Dial the feature number (9) . or Press a Loop-CO (L-CO) button
Line Access, Outside Line Group	Dial the feature number (8) and an outside line group (1-8) . or Press a Group-CO (G-CO) button.
Line Access, Individual	Press a Single-CO (S-CO) button.

<SLT and ISDN telephone users>

Line Access, Automatic	Dial the feature number (9) .
Line Access, Outside Line Group	Dial the feature number (8) and an outside line group number (1-8) .

Conditions

- The CO button assignment on your telephone can be re-arranged as required. Refer to 2.2.2 Flexible Button Assignment.
- After dialing the feature number or pressing the CO button, you will hear one of the following tones:

Dial tone : Indicates an idle outside line is accessed.

COXX

—is shown on the display. (xx: outside line number)

Busy tone : Indicates the selected outside line is busy.

CO in use

—is shown on the display.

Reorder tone :

- 1) Indicates the outside line you have attempted to access is not assigned.

CO Not Assigned

—is shown on the display.

- 2) Indicates access to outside lines is denied.

Restricted

—is shown on the display.

- **Restricted** may show on the display or if you hear a reorder tone, the call is restricted for one of the following reasons.

- The extension has been locked by the owner (Electronic Station Lockout) or the operator / manager (Remote Station Lock Control).
- The extension is restricted by the account code mode, "Verified - All Calls" or "Verified - Toll Restriction Override."
- The extension is restricted from making toll calls (Toll Restriction).

Programming Guide References

- [103] Automatic Access Outside Line Assignment
- [400] Outside Line Connection Assignment
- [605-606] Outgoing Permitted Outside Line Assignment — Day / Night
- [614-615] Outgoing Permitted Outside Line Assignment — Day / Night for ISDN Extension
- [728] T1 Extension Outgoing Permitted Outside Line Assignment – Day
- [729] T1 Extension Outgoing Permitted Outside Line Assignment – Night

Features Guide References

Toll Restriction

User Manual References

- 2.2.2 Flexible Button Assignment
- 4.3.2 Account Code Entry
- 4.3.41 Executive Busy Override — Outside Line [PT only]
- 4.4.7 Remote Station Lock Control

Line Access, Automatic

Allows you to select an available outside line automatically.

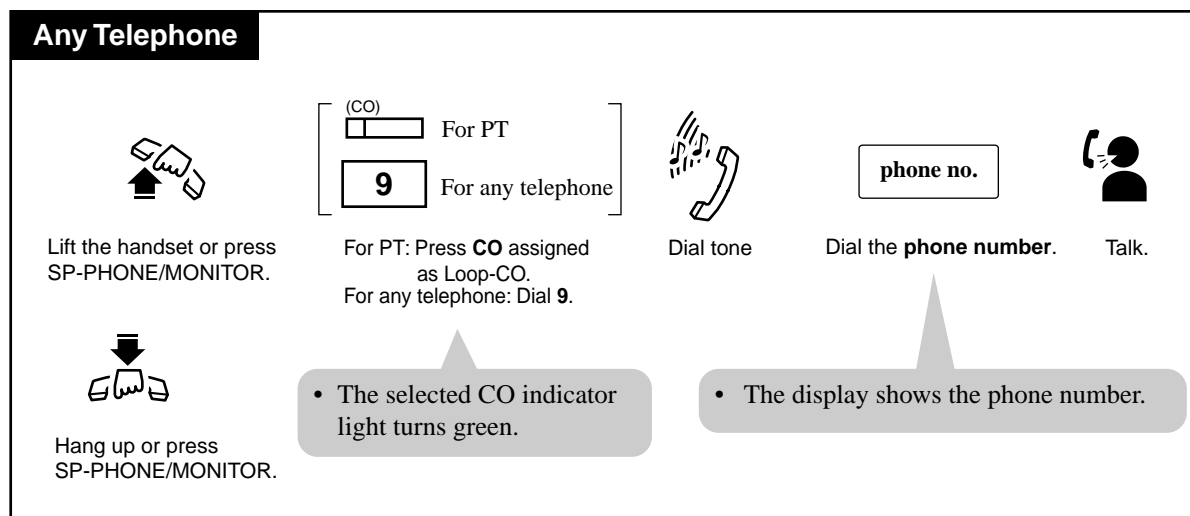

Conditions

- You may press the L-CO button directly without first going off-hook.

Line Access, Individual [PT only]

You can get an idle outside line for making a call by simply pressing a CO button (Single-CO) directly.

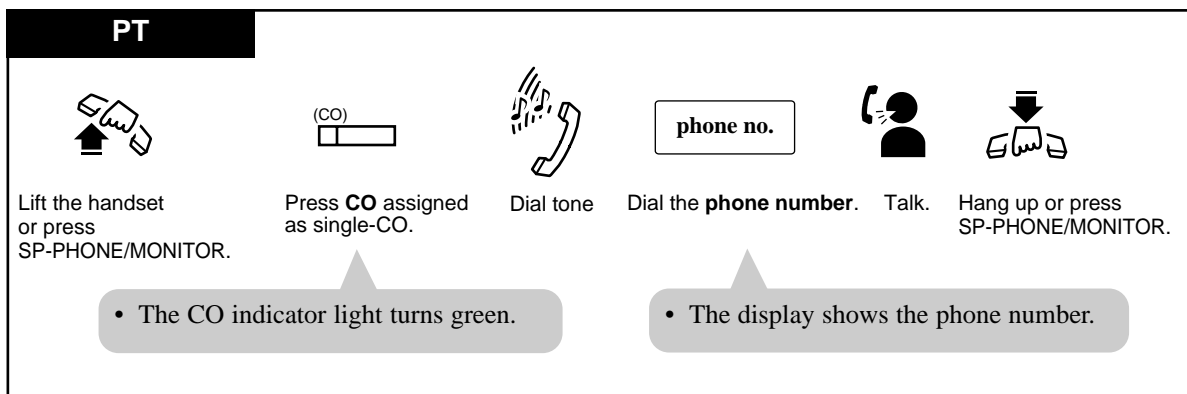

Conditions

- You may press the CO button directly without first going off-hook.

Line Access, Outside Line Group

Allows you to select an idle outside line within a designated trunk group. Through programming, outside lines can be divided into eight line groups.

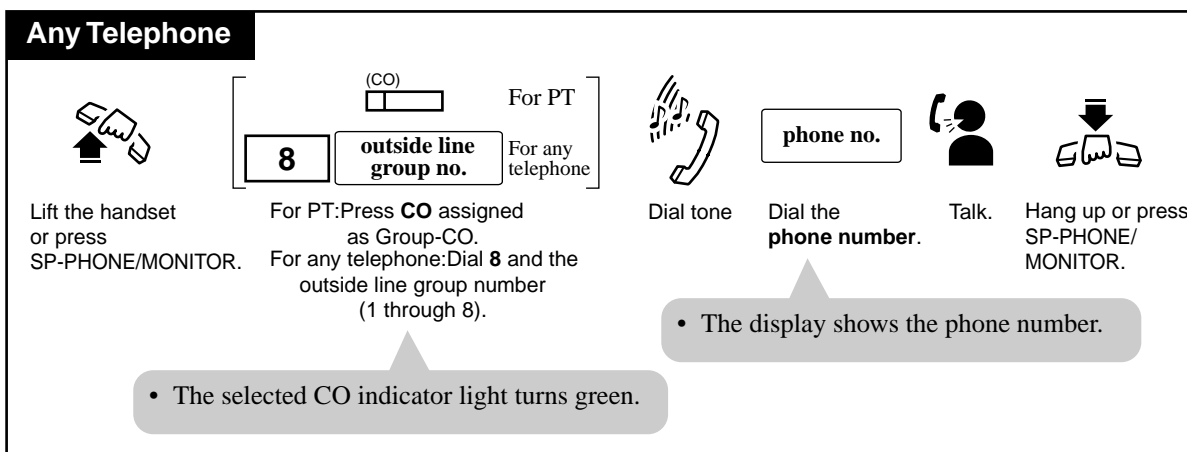

Conditions

- You may press the G-CO button directly without first going off hook.

4.3.62 Paging — SUMMARY

Allows you to make a voice announcement to several people at the same time. Your message is announced over the built-in speakers of proprietary telephones (PT) and/or external speakers (External Pagers). The paged person can answer your page from a nearby telephone. There are three types of paging as shown below. You can select the appropriate type according to your needs.

Type	Description
Paging — All	Paging through both the built-in speakers of PTs and external pagers.
Paging — External	Paging through all of the external pagers simultaneously.
	Paging to a specific external pager.
Paging — Group	Paging to all paging groups simultaneously.
	Paging to a particular group of extensions through the built-in speakers of PTs.

Conditions

- To answer the page, refer to 4.3.63 Paging — ANSWER.
- The paged extension users hear a confirmation tone before the voice announcement.
- A confirmation tone from external pagers (External Pager Confirmation Tone) is audible at the paged side, before the voice announcement. Eliminating the tone is programmable.
- A confirmation tone is sent to extension before making the voice announcement. Eliminating the tone is programmable by System Programming.

<PT>

- To deny receiving the page, refer to 4.3.64 Paging — Deny [PT only].
- With the KX-T7431, KX-T7433, KX-T7436 or KX-T7235, you can execute "Paging" feature using the display operation.

Programming Guide References

- [602] Extension Group Assignment
- [805] External Pager Confirmation Tone
- [990] System Additional Information

User Manual References

- 4.3.63 Paging — ANSWER
- 4.3.64 Paging — Deny [PT only]
- 4.5.9 KX-T7235 Display Features - System Feature Access Menu
- 4.5.12 KX-T7431 / KX-T7433 / KX-T7436 Display Features - System Feature Access Menu

Paging — All

Allows you to make a voice announcement to all extensions. Your message is announced over the built-in speakers of the proprietary telephones (PT) and external pagers.

Any Telephone

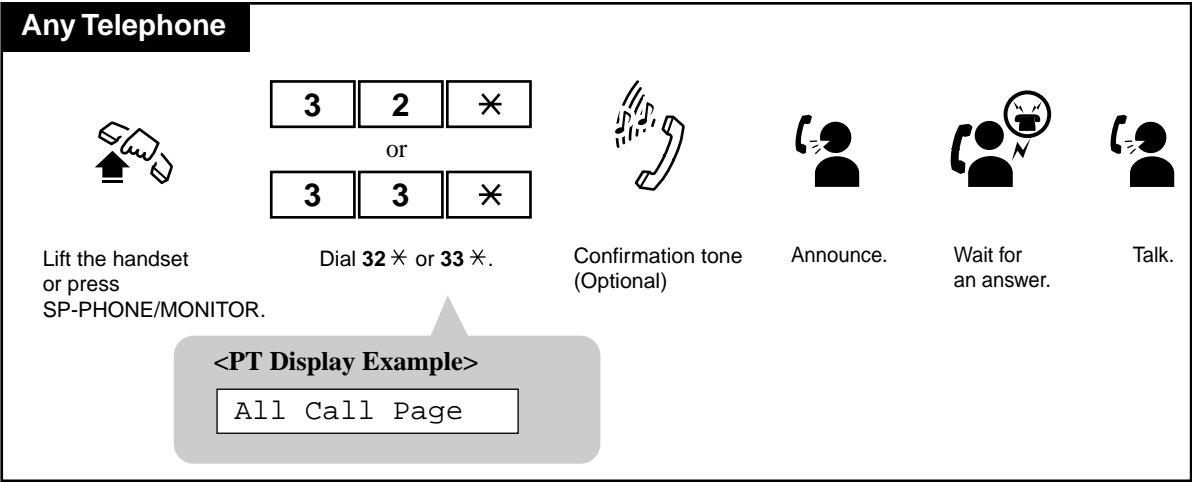

Lift the handset or press SP-PHONE/MONITOR.

Dial **3 2 *** or **3 3 ***.

Confirmation tone (Optional)

Announce.

Wait for an answer.

Talk.

<PT Display Example>
All Call Page

Paging — External

Allows you to make a voice announcement over external pagers.

To access all external pagers

Any Telephone

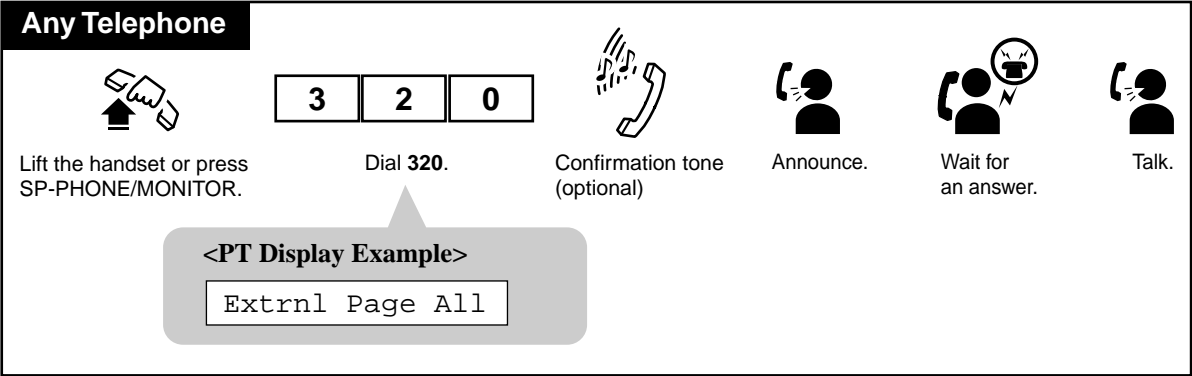

Lift the handset or press SP-PHONE/MONITOR.

Dial **3 2 0**.

Confirmation tone (optional)

Announce.

Wait for an answer.

Talk.

<PT Display Example>
Extrnl Page All

To access a particular pager

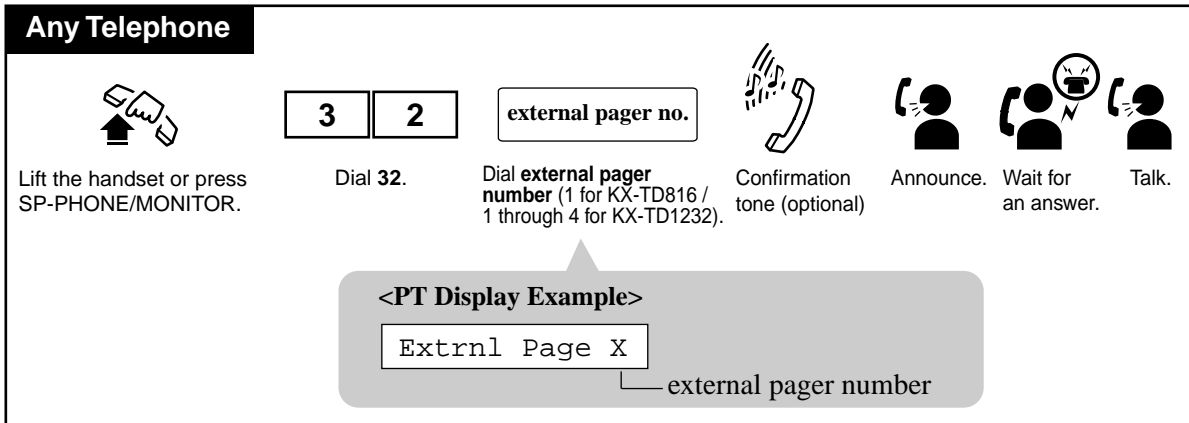

Conditions

- If the designated pager is in use, a busy tone is heard.
 - The paging priorities are as follows:
 - a) TAFAS (Trunk Answer From Any Station)
 - b) Paging – External
 - c) Background Music (BGM) – External
- If a higher priority page is requested when a lower priority page is active, the higher priority overrides the lower one.

User Manual References

- 4.4.2 Background Music (BGM) — External
- 4.3.82 Trunk Answer From Any Station (TAFAS)

Paging — Group

You can make a paging announcement by selecting a particular paging group.

You can select a maximum of 8 paging groups simultaneously.

The announcement can only be heard through the built-in speakers of PTs.

To access all paging groups (1-8) simultaneously

Any Telephone

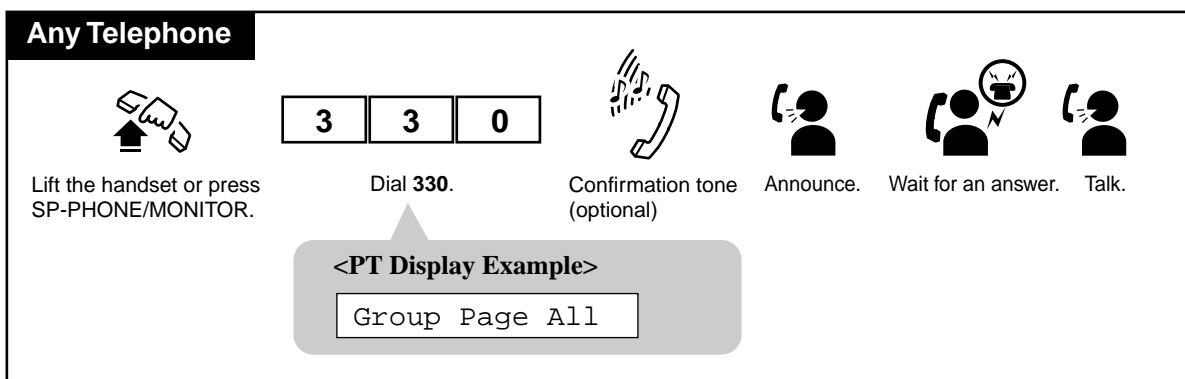

Lift the handset or press SP-PHONE/MONITOR.

Dial **330**.

Confirmation tone (optional)

Announce. Wait for an answer. Talk.

<PT Display Example>
Group Page All

To access a particular paging group

Any Telephone

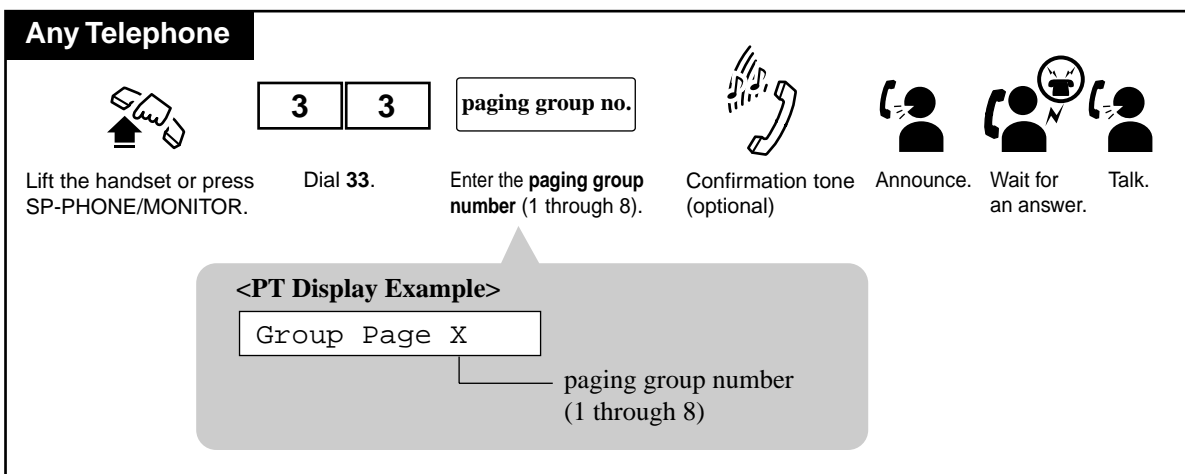

Lift the handset or press SP-PHONE/MONITOR.

Dial **33**.

Enter the **paging group number** (1 through 8).

Confirmation tone (optional)

Announce. Wait for an answer. Talk.

<PT Display Example>
Group Page X

paging group number (1 through 8)



Conditions

- There is a maximum of eight extension groups. "Paging – Group" to different groups can be performed simultaneously.
- The "Paging – Group" feature overrides Do Not Disturb (DND) at an extension.



4.3.63 Paging — ANSWER

Allows you to answer an announced page at any extension within the system.

Answering a page sent through a built-in speaker

PT and SLT					
	<table border="1"><tr><td>4</td><td>3</td></tr></table>	4	3		
4	3				
Lift the handset or press SP-PHONE/MONITOR.	Dial 43.	Confirmation tone (optional)	Talk.		

Answering a page sent through a particular external pager

PT and SLT							
	<table border="1"><tr><td>4</td><td>2</td></tr></table>	4	2	<table border="1"><tr><td>external pager no.</td></tr></table>	external pager no.		
4	2						
external pager no.							
Lift the handset or press SP-PHONE/MONITOR.	Dial 42.	Dial external pager number (1 for KX-TD816 / 1 through 4 for KX-TD1232).	Confirmation tone (optional)	Talk.			

Conditions

- Only extensions within the paged group can answer "Paging — Group."
- A confirmation tone is audible when the page is answered. Eliminating the tone is programmable by System Programming.

<PT>

- With the KX-T7431, KX-T7433, KX-T7436 or KX-T7235, you can execute this feature using the display operation.

<ISDN Telephone>

- The ISDN telephone users can only answer a page sent to an external pager.

Programming Guide References

[990] System Additional Information

User Manual References

4.5.9 KX-T7235 Display Features - System Feature Access Menu

4.5.12 KX-T7431 / KX-T7433 / KX-T7436 Display Features - System Feature Access Menu

4.3.64 Paging — Deny [PT only]

Allows you to deny receiving paging announcement through the built-in speakers of your telephone.

Setting

PT



Lift the handset or press
SP-PHONE/MONITOR.

7	2	1	1
---	---	---	---

Dial **7211**.



Confirmation tone



Hang up or press
SP-PHONE/MONITOR.

<PT Display Example>

Paging Deny On

Canceling

PT



Lift the handset or press
SP-PHONE/MONITOR.

7	2	1	0
---	---	---	---

Dial **7210**.



Confirmation tone



Hang up or press
SP-PHONE/MONITOR.

<PT Display Example>

Paging Deny Off

Conditions

- With the KX-T7431, KX-T7433, KX-T7436 or KX-T7235, you can execute this feature using the display operation.

User Manual References

4.5.9 KX-T7235 Display Features - System Feature Access Menu

4.5.12 KX-T7431 / KX-T7433 / KX-T7436 Display Features - System Feature Access Menu

4.3.65 Paging and Transfer

You can transfer a call after making a paging announcement via Paging — All, Paging — External, or Paging — Group.

Using Paging — All

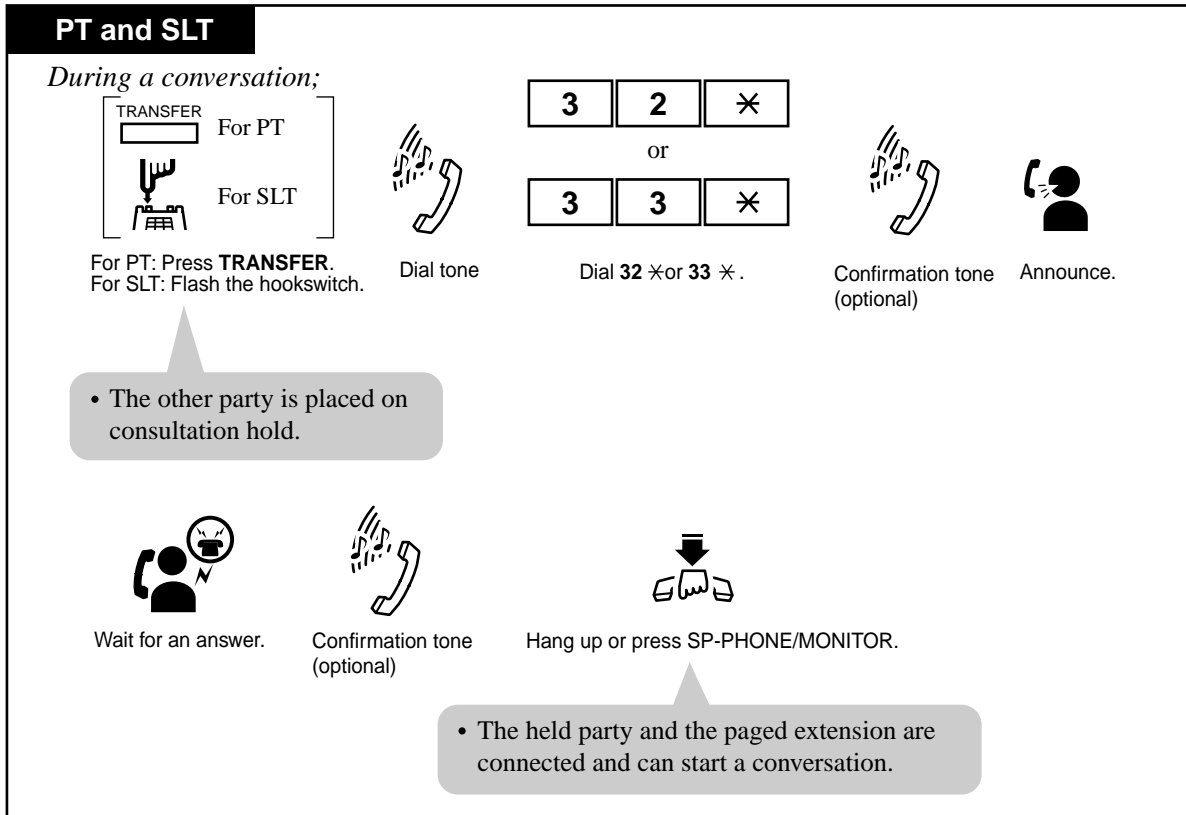



Using Paging — External: to all external pagers

PT and SLT

During a conversation;

TRANSFER For PT

 For SLT



Dial tone

3	2	0
---	---	---

Dial **320**.



Confirmation tone
(optional)



Announce.

For PT: Press **TRANSFER**.
For SLT: Flash the hookswitch.

- The other party is placed on consultation hold.



Wait for an answer.



Confirmation tone
(optional)



Hang up or press SP-PHONE/MONITOR.

- The held party and paged extension are connected and can start a conversation.

Using Paging — External: to a particular external pager

PT and SLT

During a conversation;

TRANSFER For PT

 For SLT



Dial tone

3	2
---	---

Dial **32**.

external pager no.

Dial external **pager number**
(1 for KX-TD816 /
1 through 4 for KX-TD1232).



Confirmation tone
(optional)

For PT: Press **TRANSFER**.
For SLT: Flash the hookswitch.

- The other party is placed on consultation hold.



Announce.



Wait for an answer.



Confirmation tone
(optional)



Hang up or press SP-PHONE/MONITOR.

- The held party and paged extension are connected and can start a conversation.

Using Paging — Group: to all paging groups

PT and SLT

During a conversation;

TRANSFER For PT

 For SLT



3

3

0



For PT: Press **TRANSFER**.
For SLT: Flash the hookswitch.

Dial tone

Dial **330**.

Confirmation tone (optional)

- The other party is placed on consultation hold.



Announce.



Wait for an answer.



Confirmation tone (optional)



Hang up or press SP-PHONE /MONITOR.

- The held party and the paged extension are connected and can start a conversation.

Using Paging — Group: to a particular paging group

PT and SLT

During a conversation;

TRANSFER For PT

 For SLT



3

3

paging group no.



For PT: Press **TRANSFER**.
For SLT: Flash the hookswitch.

Dial tone

Dial **33**.

Enter a **paging group number** (1 through 8).

Confirmation tone (optional)

- The other party is placed on consultation hold.



Announce.



Wait for an answer.



Confirmation tone (optional)



Hang up or press SP-PHONE/MONITOR

- The held party and the paged extension are connected and can start a conversation.

Conditions

- A confirmation tone is audible before making the voice announcement.
Eliminating the tone is programmable.

Programming Guide References

- [602] Extension Group Assignment
- [805] External Pager Confirmation Tone
- [990] System Additional Information

4.3.66 Paralleled Telephone Connection

A Proprietary Telephone (PT) can be connected in parallel with a single line telephone (SLT). This feature allows you to enable or disable SLT ringing. When a parallel connection is made, either telephone can be used.

To enable / disable SLT ringing

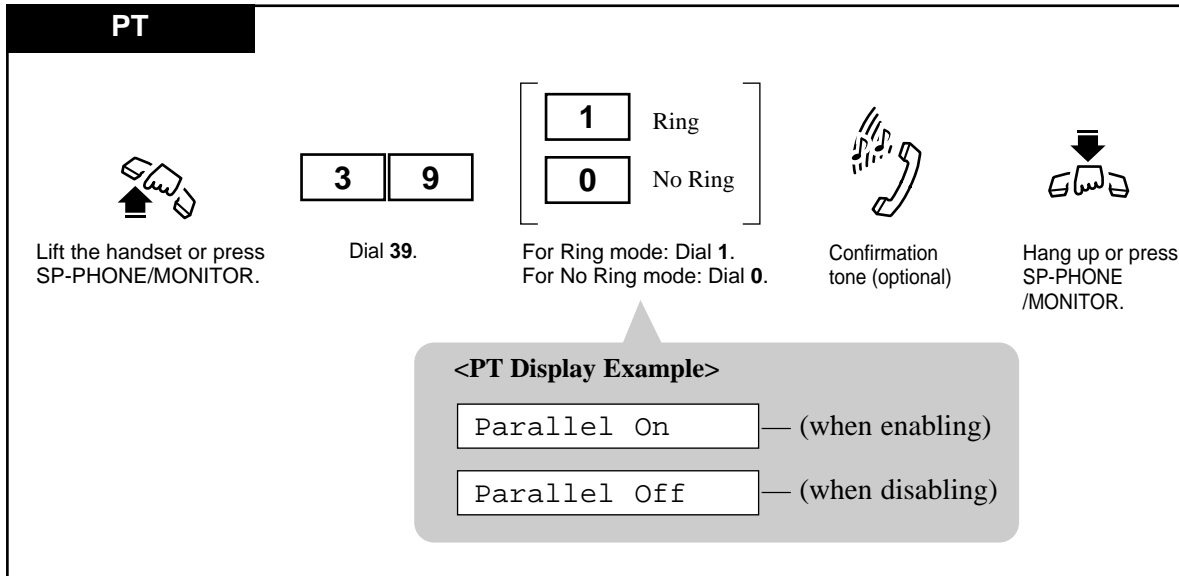

Conditions

- The default is "Parallel Off (No ring)".
- The PT can be used to perform normal operations whether or not the SLT is set to ring.
- **When receiving a call:**
 - If SLT ringing is enabled, then both the PT and the SLT will ring except when the PT is in "Hands-free Answerback" mode or Voice-Calling mode with the "Alternate Calling — Ring/Voice" feature.
 - If SLT ringing is disabled, then the PT rings but the SLT does not. However, the SLT can answer the call.
- When the SLT is in use, the display and the indicators of the PT will work in the same way as if the PT is in use.
- In the DPT + SLT combination, if one telephone goes off-hook while the other telephone is on a call, the call is switched to the former.
- If you go off-hook while your paralleled telephone is in use, the call will switch over to your telephone, and vice versa.
- The "XDP^{*1}" feature is available.

^{*1} XDP (eXtra Device Port) expands the number of telephones available in the system by allowing an extension port to contain two telephones. For more details, please consult with your dealer.

<PT>

- With the KX-T7431, KX-T7433, KX-T7436, or KX-T7235, you can execute this feature using the display operation.

<ISDN Telephone>

- This feature is not available for ISDN telephones.

Feature Guide References

EXtra Device Port (XDP)

User Manual References

- 4.3.3 Alternate Calling — Ring / Voice
- 4.3.47 Hands-free Answerback [PT only]
- 4.5.9 KX-T7235 Display Features - System Feature Access Menu
- 4.5.12 KX-T7431 / KX-T7433 / KX-T7436 Display Features - System Feature Access Menu

4.3.67 Phantom Extension

Allows you to route calls to a phantom extension. The call arrives at the extension who has the corresponding Phantom button. A flexible CO button can be assigned as the Phantom button. The lighting patterns of Phantom button and status are as follows.

Off : Idle

Red : You are calling a phantom extension.

Flashing green rapidly : Incoming call

To call a phantom extension

PT

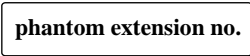

While the Phantom button indicator light is off;

(Phantom)  or 

Press **Phantom** (flexible button). Dial the **phantom extension number**.

- You may dial the phantom extension number instead.
- The Phantom indicator light turns red (steady).

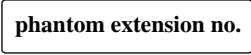
Any Telephone

  

Lift the handset or press SP-PHONE /MONITOR. Dial the phantom extension number. Talk.

To transfer a call to a phantom extension (Screened Call Transfer)

PT

During a conversation;

 Press **TRANSFER**.

 Confirmation tone

 Dial tone

 (Phantom)

Press **Phantom** (flexible button).

 Ringback tone

- The other party is placed on consultation hold.
- You may dial the phantom extension number instead.

 Wait for an answer.

 Announce.

 Hang up or press SP-PHONE/MONITOR.

- The call is transferred.

SLT

During a conversation;

 Flash the hookswitch.

 Confirmation tone

 Dial tone

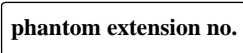
 phantom extension no.

Dial the destination **phantom extension number**.

 Ringback tone

- The other party is placed on consultation hold.

 Wait for an answer.

 Announce.

 Hang up.

- The call is transferred.

To transfer a call to a phantom extension (Unscreened Call Transfer)

PT

During a conversation;

Press **TRANSFER**.

Confirmation tone

Dial tone

Press **Phantom** (flexible button).

Ringback tone

Hang up or press SP-PHONE/MONITOR.

- The other party is placed on hold. consultation hold.
- Ringing starts at the destination extension.
- The call is transferred.

SLT

During a conversation;

Flash the hookswitch.

Confirmation tone

Dial tone

phantom extension no.

Dial the destination phantom extension number.

Ringback tone

Hang up.

- The other party is placed on hold. consultation hold.
- Ringing starts at the destination extension.

To answer a phantom extension call

PT

While the Phantom button indicator light is flashing green;

Press **Phantom** (flexible button).

Conditions

- A phantom number must be assigned by System Programming before assigning the Phantom Extension button by Station Programming or System Programming.
- If several extensions have the same phantom extension number, they will ring simultaneously.
- A maximum of 128 phantom numbers can be assigned by System Programming.
- The Phantom button cannot be used for feature settings such as "Call Forwarding".
- It is programmable not to ring the extension when a call is received at a phantom extension by Station Programming.
- **Phantom Extension button on a DSS Console:**
Allows the operator to transfer a call to a phantom extension by the Phantom Extension button on the DSS Console.

Programming Guide References

[005] Flexible CO Button Assignment

[124] Phantom Extension Number Assignment

User Manual References

2.2.2 Flexible Button Assignment

2.2.3 Phantom Extension Ringing On/Off Set

4.3.68 Pickup Dialing (Hot Line)

You can make a call to the pre-programmed party simply by going off-hook.

Programming the phone number

Any Telephone



Lift the handset or press
SP-PHONE/MONITOR.

7	4	2
---	---	---

Dial **742**.

phone no.	#
-----------	---

Enter the **phone number**. Dial #.



Confirmation
tone and
dial tone



Hang up or press
SP-PHONE/MONITOR.

- You must dial a line access code (9 or 81 through 88) as the first digit when storing an outside phone number.

Setting / Canceling

Any Telephone



Lift the handset or press
SP-PHONE/MONITOR.

7	4	1	To set.
7	4	0	To cancel.

To set: Dial **741**.
To cancel: Dial **740**.



Confirmation
tone and
dial tone



Hang up or press
SP-PHONE/MONITOR.

Dialing

Any Telephone



Lift the handset or press
SP-PHONE/MONITOR.



Wait for an answer.



Talk.

Conditions

- This feature does not work if you go off-hook to answer an incoming call or retrieve a call on hold.
- Up to 16 digits, consisting of "0 through 9" and "*", can be stored. "#" cannot be stored.
- Valid digits are "0 through 9", "*" and PAUSE button. For SLT users, PAUSE (pausing time) can be stored by dialing **.
- During the waiting time after going off-hook, you can dial another party and override this feature. This waiting time (between going off-hook and connecting with the called line) can be changed by System Programming. (Default: 1 second)
- With the KX-T7431, KX-T7433, KX-T7436 or KX-T7235, you can execute this feature using the display operation.

<ISDN Telephone>

- This feature is not available for ISDN telephones.

Programming Guide References

[204] Pickup Dial Waiting Time

User Manual References

4.5.9 KX-T7235 Display Features - System Feature Access Menu

4.5.12 KX-T7431 / KX-T7433 / KX-T7436 Display Features - System Feature Access Menu



4.3.69 Privacy Release [PT only]

Allows you to establish a three-party conference call while connected to an existing call.

Setting

PT

During a conversation with an outside party, to allow another extension to join the conversation;

-at your extension	-at the other extension	
(CO) 	(CO) 	

Press the corresponding **CO**.

Press the flashing **CO** within five seconds.

Confirmation tone (optional)

- The corresponding CO indicator light flashes green rapidly.
- A three-party conference is now established.

To leave the conference

PT





Hang up or press SP-PHONE/MONITOR.

- The other two parties may continue their conversation.

To terminate one party and talk to the other

PT

(CO) INTERCOM
 OR 

Press **CO** or **INTERCOM** of the desired party.

Conditions

- The CO button pressed to join the conversation needs to be assigned as a Single-CO (S-CO) button.
- After the user presses the CO button, the CO indicator light of the other extension flashes rapidly for only 5 seconds. Pressing the CO button again gives you an additional 5 seconds.
- This feature overrides "Data Line Security" and "Executive Busy Override Deny."
- When a two-party call is changed to a three-party call and vice versa, a confirmation tone is sent to all three parties. Eliminating the tone is programmable.

Programming Guide References

[990] System Additional Information

User Manual References

- 2.2.2 Flexible Button Assignment
- 4.3.30 Conference
- 4.3.33 Data Line Security
- 4.3.42 Executive Busy Override Deny

4.3.70 Pulse to Tone Conversion

You can change the dialing mode from Pulse to Tone temporarily to access services such as computer telephone services, Voice Mail, etc., that require a tone.

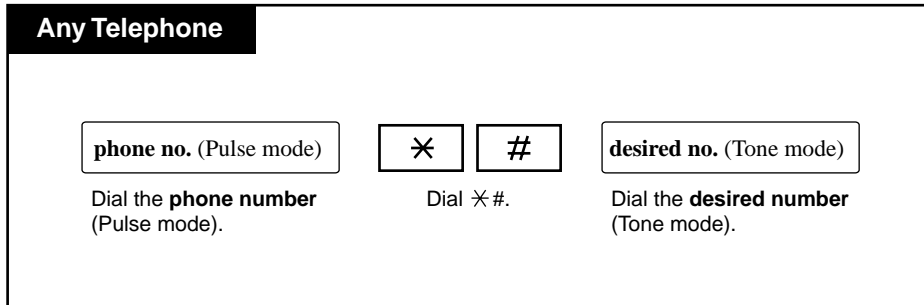

Conditions

- You cannot change the dialing mode from Tone to Pulse.

4.3.71 Quick Dialing

Allows you to make a quick dial call by dialing a pre-assigned quick dial number. For example, Quick Dialing is convenient for room service calls in a hotel.

Dialing

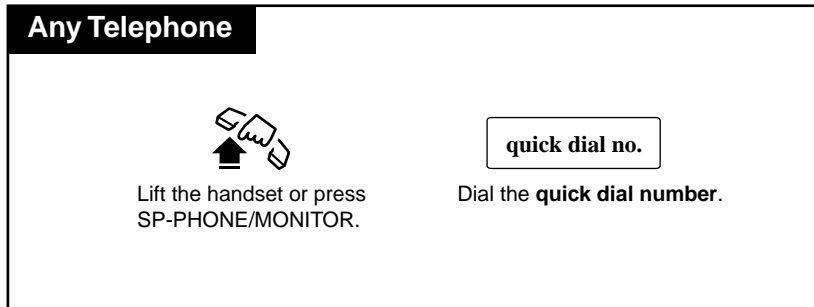

Conditions

- Up to eight quick dial numbers can be stored by System Programming.
- You must assign a feature number in program [100] Flexible Numbering in the programming Guide first and then a quick dial number in program [009] Quick Dial Number Set in the Programming Guide in order for Quick Dial to be effective.
- Quick Dialing is convenient for frequently dialed phone numbers.





Programming Guide References

[009] Quick Dial Number Set

[100] Flexible Numbering

4.3.72 Redial, Last Number

Automatically saves the last outside call number you dialed so that you can make a call to the same party later with a simple operation.

PT	SLT and ISDN Telephone
 Lift the handset or press SP-PHONE/MONITOR.	 Lift the handset.
 Press REDIAL .	 Dial #.

Conditions

- Up to 24 digits can be stored and redialed; this does not include an outside line access code.
- "*", "#", "PAUSE", and "INTERCOM" (for secret dialing) are counted as one digit.
- The memorized telephone number is replaced by a new one if at least one digit sent to an outside line is dialed. Dialing an outside line access code alone does not change the memorized number.

<PT>

- If you hear a busy tone when attempting to redial, select another line and press the REDIAL button.

<SLT and ISDN Telephone>

- If you hear a busy tone when attempting to redial, select another line and dial "#".

4.3.73 Redial, Saved Number [PT only]

Allows you to store a telephone number during the conversation, so that you can redial the same party later with a simple operation. The saved number can be redialed until another number is stored.

Storing

PT

During a conversation or while hearing a busy tone;

AUTO DIAL



STORE

Press **STORE**.

(SAVE)



Press **SAVE** (flexible button).

Dialing

PT



Lift the handset or press
SP-PHONE/MONITOR.

(SAVE)



Press **SAVE** (flexible button).

Conditions

- Up to 24 digits can be stored and redialed; excluding a line access code.
- "×", "#", "PAUSE", and "INTERCOM" (for secret dialing) are counted as one digit.
- **SAVE button**
A flexible button can be assigned as the SAVE button by Station, User or System Programming.

User Manual References

- 2.2.2 Flexible Button Assignment

4.3.74 Secret Dialing [PT only]

Allows you to conceal all or part(s) of a "System Speed Dialing" or "One-Touch Dialing" number assigned to a flexible button on your PT and DSS console which normally appears on the display. Additionally, KX-T7431, KX-T7433, KX-T7436 and KX-T7235 Model Telephones are capable of Secret Dialing for "Station Speed Dialing" numbers.

PT

When storing the phone number;



Press **INTERCOM** before and after the part you wish to conceal.

<PT Display Example>

9-1-[123]. . .

– "123" is not shown on the display when you dial.

Conditions

- The secret code, "[" or "]" (pressing the INTERCOM button), are counted as one digit.
- You can conceal one or more parts of a telephone number.
- If the phone number "9-1-[123]-456-7890" has been stored, the display shows the following when the call is made:

-1-. . .-456-7890
- The concealed part will be printed out by Station Message Detail Recording (SMDR).

Programming Guide References

[001] System Speed Dialing Number Set

User Manual References

- 2.2.2 Flexible Button Assignment
- 2.2.8 Station Speed Dialing Number/Name Assignment [KX-T7235/KX-T7431/KX-T7433/KX-T7436 only]
- 3.2.2 [001] System Speed Dialing Number Set
- 4.3.59 One-Touch Dialing [PT only]
- 4.3.76 Station Speed Dialing
- 4.3.77 System Speed Dialing

4.3.75 Station Program Clear

Allows you to reset the following station features to the default settings.

(a)	Absent Message Capability (The message set on your extension)
(b)	Automatic Callback Busy (Camp-On)
(c)	Background Music that has been turned on*
(d)	Call Forwarding
(e)	Call Log, Incoming
(f)	Call Pickup Deny
(g)	Call Waiting
(h)	Data Line Security
(i)	Do Not Disturb (DND)
(j)	Executive Busy Override Deny
(k)	Log-In / Log-Out
(l)	Message Waiting (All messages that have been left on your extension by other extension users)
(m)	Off-Hook Call Announcement (OHCA)*
(n)	Paging Deny*
(o)	Paralleled Telephone Connection*
(p)	Pickup Dialing (Hot Line) – (The stored telephone number will be removed)
(q)	Timed Reminder
(r)	Whisper OHCA*

*: PT only

Clearing the current feature settings

Any Telephone

Lift the handset or press SP-PHONE/MONITOR.

Dial **790**.

Confirmation tone and dial tone

Hang up or press SP-PHONE/MONITOR.

<PT Display Example>
Ext Data Clear

Conditions

- With the KX-T7431, KX-T7433, KX-T7436 or KX-T7235, you can execute this feature using the display operation.



User Manual References

- 4.5.9 KX-T7235 Display Features - System Feature Access Menu
- 4.5.12 KX-T7431 / KX-T7433 / KX-T7436 Display Features - System Feature Access Menu

4.3.76 Station Speed Dialing

Allows you to store up to 10 speed dial numbers at your extension. These numbers are available for your extension only.

Storing the phone number

Any Telephone						
	3	0	station speed dial no.	desired no.	#	
Lift the handset or press SP-PHONE/MONITOR.	Dial 30 .		Enter the station speed dial number (0 through 9).	Enter the desired number .	Dial # .	Confirmation tone and dial tone
						
						Hang up or press SP-PHONE/MONITOR.

Dialing

Any Telephone		
	3	*
Lift the handset or press SP-PHONE/MONITOR.	Dial 3* .	station speed dial no.
		Enter the station speed dial number (0 through 9).

Conditions

- You can store an extension number, a telephone number, or a feature number up to 16 digits. Valid digits are "0 through 9", "*" and PAUSE button. For SLT users, PAUSE (pausing time) can be stored by dialing**.
- To store the telephone number of an outside party, the line access code (9 or 81 through 88) must be stored as the leading digit.
- "Station Speed Dialing" can be followed by manual dialing to supplement the dialed digits.

<PT>

- One-Touch Dialing**

A PT user may make a call with One-Touch Dialing button, instead of Station Speed Dialing.

- With the KX-T7431, KX-T7433, KX-T7436 or KX-T7235, you can execute this feature using the display operation.
- With the KX-T7431, KX-T7433, KX-T7436 and KX-T7235, you can store not only phone numbers but names as well.

<SLT>

- The SLT may be replaced with a PT temporarily to store one-touch dialing into memory. The Function Buttons (F1 through F10) correspond to speed dial numbers as follows:

F1 — 0	F6 — 5
F2 — 1	F7 — 6
F3 — 2	F8 — 7
F4 — 3	F9 — 8
F5 — 4	F10 — 9

User Manual References

2.2.2 Flexible Button Assignment

2.2.8 Station Speed Dialing Number/Name Assignment [KX-T7235/KX-T7431/KX-T7433/
KX-T7436 only]

4.5.8 KX-T7235 Display Features - Call Directory

4.5.11 KX-T7431 / KX-T7433 / KX-T7436 Display Features - Call Directory

4.3.77 System Speed Dialing

Allows you to make a call using speed dial numbers programmed previously. This system supports **five hundred** speed dial numbers which are available to all extension users.

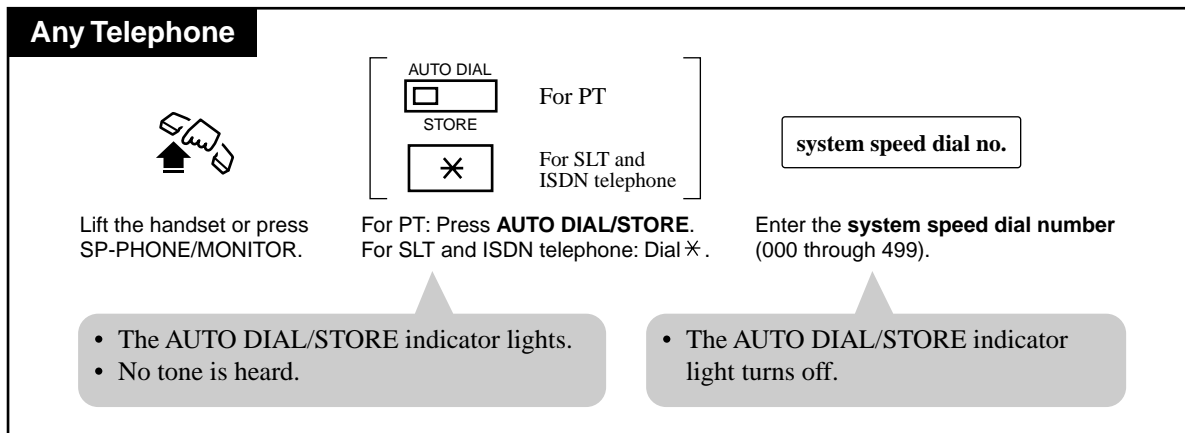

Conditions

- System Speed Dial numbers must be stored either by the User (Manager) or System Programming.
- It is possible to cancel toll restriction with this feature (Toll Restriction Override for System Speed Dialing). In this case, System Programming is necessary.

<PT>

- "Speed Dialing", "One-Touch Dialing", "Redial, Last Number/Saved Number" and manual dialing can be used together.
- Continuous use of a speed dial number is possible, if the number is divided when stored.
<Example>
If the number is divided and stored in System Speed Dial numbers 001 and 002;
Press: [AUTO DIAL/STORE] [0] [0] [1] [AUTO DIAL/STORE] [0] [0] [2]
- The dialed number appears on the display.
- You may press a CO button to select a desired outside line before pressing the AUTO DIAL/STORE button.
- With the KX-T7431, KX-T7433, KX-T7436 or KX-T7235, you can execute this feature using the display operation.

Programming Guide References

[001] System Speed Dialing Number Set

[002] System Speed Dialing Name Set

User Manual References

- 3.2.2 [001] System Speed Dialing Number Set
- 3.2.3 [002] System Speed Dialing Name Set
- 4.3.81 Toll Restriction Override for System Speed Dialing
- 4.5.8 KX-T7235 Display Features - Call Directory
- 4.5.11 KX-T7431 / KX-T7433 / KX-T7436 Display Features - Call Directory

4.3.78 Timed Reminder

Allows you to set your extension to sound an alarm once or daily at a preset time. Each telephone can be set to generate an alarm tone at a preset time as a reminder. When this feature is set, an alarm tone will ring for 30 seconds (default) at the programmed time.

Wake-Up Call

If a voice message is recorded beforehand, wake-up message is heard instead of an alarm tone when an extension user goes off-hook.

This feature can be activated only once or everyday at a specified time.

Setting

PT and SLT



Lift the handset or press
SP-PHONE/MONITOR.

7

6

1

Dial **761**.

hour

Enter the **hour**
(01 through 12).

minute

Enter the **minute**
(00 through 59).

0

or

1

For AM: Dial **0**.
For PM: Dial **1**.

0

or

1

For a one time alarm*¹: Dial **0**.
For a daily alarm*²: Dial **1**.



Confirmation
tone and
dial tone



Hang up or press
SP-PHONE/MONITOR.

*¹ An alarm will be heard at the preset time and then the setting is cleared.
*² An alarm will be heard daily at the preset time until the setting is changed or canceled.

Canceling

PT and SLT



Lift the handset or press
SP-PHONE/MONITOR.

7

6

0

Dial **760**.



Confirmation tone
and dial tone



Hang up or press
SP-PHONE/MONITOR.

<PT Display Example>
Alarm Cancelled

Checking the setting time

Display PT



Lift the handset or press
SP-PHONE.

7

6

2

Dial **762**.



Dial tone



Hang up or press
SP-PHONE.

- If "10:10 AM" has been set:
<PT Display Example>

Alarm 10:10AM
– one time

or

Alarm 10:10AM*
– daily

Stopping the alarm

PT and SLT



Lift the handset or press SP-PHONE/MONITOR.

- Pressing any key also stops the alarm (PT only).

Conditions

- **System Time**
The system clock must be set before the alarm is set.
- If you are connected to a KX-TD1232 System, Timed Reminder message can be recorded by the Manager or an Operator. ("Outgoing Message (OGM)"). When the alarm is heard, you can hear the message by going off-hook, if it has been recorded. You hear an intermittent tone (dial tone 3) instead of the message in the following cases:
 - a) A DISA Card is not equipped.
 - b) All DISA ports are busy or OUS (Out-of-Service).
 - c) The Timed Reminder message has not been stored.
- If other extension user calls your extension when the alarm is sounding, he or she will hear a busy tone.
- If you receive an incoming call during the alarm, the ringing starts after the alarm stops.
- If you are having a conversation at the time the alarm is set to sound, the alarm starts after the conversation.

- **Station Message Detail Recording (SMDR)**
SMDR automatically records the detailed Timed Reminder information (data, time, extension number, start/no answer). It is programmable by System Programming to print out when the Timed Reminder starts and the alarm is not answered.
- Setting a new time clears the preset time.
- **Timed Reminder Ringing Time**
The alarm continues for a specified period of time (default: 30 s).
This period of time can be changed by System Programming.

<PT>

- If an alarm time has not been set, the display shows the following:

Alarm Not Stored

- With the KX-T7431, KX-T7433, KX-T7436 and KX-T7235, you can set or cancel the Timed Reminder using the display operation.

<ISDN Telephone>

- This feature is not available for ISDN telephones.

Programming Guide References

- [000] Date and Time Set
- [217] Timed Reminder Alarm Ring Time
- [990] System Additional Information

User Manual References

- 3.2.1 [000] Date and Time Set
- 4.4.6 Outgoing Message (OGM)
- 4.5.9 KX-T7235 Display Features - System Feature Access Menu
- 4.5.12 KX-T7431 / KX-T7433 / KX-T7436 Display Features - System Feature Access Menu

4.3.79 Toll Restriction Override — SUMMARY

There are two types of toll restriction override:

- **Toll Restriction Override by Account Code Entry**
- **Toll Restriction Override for System Speed Dialing**

4.3.80 Toll Restriction Override by Account Code Entry

Allows you to temporarily override toll restriction and make a toll call from a toll-restricted telephone. You can carry out this feature by entering an appropriate account code before dialing the telephone number. For operation procedure, refer to 4.3.2 Account Code Entry.

Conditions

- This feature changes the toll restriction level to level 2. This can be used by extension users assigned to restriction levels 3 through 8. Levels 1 and 2 can not be changed.
- A "Class of Service" which is assigned to the "Account Code Entry — Verified - Toll Restriction Override" mode permits the class members to override their toll restrictions.
- Up to 128 account codes can be programmed for the Verified mode.
- If you do not enter an account code or you enter an invalid account code, standard toll restriction is in effect.

Programming Guide References

- [105] Account Codes
- [500-501] Toll Restriction Level — Day / Night
- [508] Account Code Entry Mode
- [601] Class of Service

Features Guide References

- Toll Restriction

User Manual References

- 2.2.2 Flexible Button Assignment
- 4.3.2 Account Code Entry

4.3.81 Toll Restriction Override for System Speed Dialing

Allows you to cancel toll restriction in "System Speed Dialing." Normally, calls originated by "System Speed Dialing" are restricted depending on the extension's toll restriction level. Once this option is set, it permits all extension users to make "System Speed Dialing" calls with no restrictions. You can override toll restriction for "System Speed Dialing" through System Programming.

Programming Guide References

[300] TRS Override for System Speed Dialing

Features Guide References

Toll Restriction

User Manual References

4.3.77 System Speed Dialing

4.3.82 Trunk Answer From Any Station (TAFAS)

Allows you to answer an incoming outside call, paged through an external pager, from any extension.

Any Telephone

While hearing a tone from the external pager;



Lift the handset or press
SP-PHONE/MONITOR.

4

2

Dial **42**.

external pager no.

Enter an **external pager number** (1 for KX-TD816 / 1 through 4 for KX-TD1232).



Confirmation tone (optional)

- You are connected to the ringing line and can talk to the caller.

Conditions

- TAFAS can be used in the following cases:
 - a) The floating number^{*1} of an external pager is assigned as the Direct in Lines (DIL) 1:1 destination. In this case all of the incoming calls on the specified line will be signaled.
 - b) A DISA (Direct Inward System Access) caller dials the floating number of an external pager.
 - c) The floating number of an external pager is assigned as the Intercept Routing destination. In this case incoming calls redirected to the destination will be signaled.
- **Confirmation Tone**
A confirmation tone is sent to the extension user before being connected to the caller. Eliminating the tone is programmable.

Programming Guide References

[407-408] DIL 1:1 Extension — Day / Night
 [409-410] Intercept Extension — Day / Night
 [813] Floating Number Assignment
 [990] System Additional Information

Features Guide References

Floating Station

^{*1} A Floating Number (FN) is a virtual extension number which appears to be an extension. Refer to "Floating Station" in the Features Guide.

4.3.83 Two-Way Recording into Voice Mail *1 [PT only]

Allows you to record a conversation into your mailbox or the desired mailbox.

Recording into your mailbox

PT

During a conversation;

(Two-Way-Rec)

Press **Two-Way Record**
(flexible button).

- The Two-Way Record indicator light turns red.

Stopping recording

PT

(Two-Way-Rec)

Press **Two-Way Record**
(flexible button) again.

- The Two-Way Record indicator light turns off.

*1 Available when the Digital Super Hybrid System is connected to a Digital Proprietary Telephone capable Panasonic Voice Processing System (one that supports digital proprietary telephone integration; e.g., KX-TVS100).

Recording into the mailbox of another extension

PT

During a conversation;

(Two-Way-Tran) extension no. OR phantom extension no. OR (DSS)

Press **Two-Way Transfer** (flexible button). Dial the **extension number**, the **phantom extension number** or press DSS (flexible button) where you left a message notification.

• The Two-Way Transfer indicator light turns red.

Stopping recording

PT

(Two-Way-Tran)

Press **Two-Way Transfer**(flexible button).

• The Two-Way Transfer indicator light turns off.

Conditions

- A flexible CO and DSS button can be assigned as a Two-Way Record button or a Two-Way Transfer button.
- Pressing the Two-Way Record button sends an alarm tone, if no idle voice mail port exists.
- Pressing the Two-Way Transfer button followed by an extension number sends an alarm tone, if no idle voice mail port exists.
- When you record Two-way telephone conversations, you should inform the other party that the conversation is being recorded.
- **Two-Way Recording into Phantom mailbox:**
Allows you to record a conversation into the Phantom mailbox by entering the phantom extension number after pressing the Two-way Transfer button. The Phantom Message Waiting indicator light turns on. It will turn off after one of the phantom extension users listens to the recorded conversation.

User Manual References

- 2.2.2 Flexible Button Assignment

4.3.84 Uniform Call Distribution (UCD)

Allows incoming calls to be distributed uniformly to a specific group of extensions called an UCD group. Calls to an UCD group search for an idle extension in a circular way. If all extensions in an UCD group are busy or not available, the incoming outside call will be handled by the UCD Table.

Conditions

- UCD can be used in the following cases.
 - a) The floating number^{*1} of UCD is assigned as the Direct In Lines (DIL) 1:1 destination.
 - b) The floating number of UCD is assigned as the Direct Inward Dialing (DID) destination.
 - c) The floating number of UCD is assigned as the Intercept Routing destination.
 - d) The floating number of UCD is dialed from an extension.
 - e) The floating number of UCD is dialed from DISA (Direct Inward System Access).
 - f) The floating number of UCD is assigned as the UCD Overflow destination.
- It is possible to set the log-in or log-out status on an extension basis.

Programming Guide References

[106] Station Hunting Type
[122] UCD Overflow
[123] UCD Time Table
[813] Floating Number Assignment
[991] COS Additional Information

User Manual References

4.3.52 Log-In / Log-Out

*1 A Floating Number (FN) is a virtual extension number which appears to be an extension. For more details, please consult with your dealer.

4.3.85 Voice Mail Integration

Allows you to have your calls forwarded to your Voice Processing System mailbox. If your telephone has a MESSAGE button, the button light turns on and lets you know you have messages. Even if you do not have a MESSAGE button, you will hear a special tone when going off-hook.

Setting Call Forwarding destination to Voice Mail

Any Telephone



Lift the handset or press SP-PHONE/MONITOR.

FWD/DND

For PT

7

1

0

For any telephone

FWD no.

For PT :Press **FWD/DND.**
For any telephone :Dial **710.**

Dial the FWD number.

FWD-All Calls	: Dial 2.
FWD-Busy	: Dial 3.
FWD-No Answer	: Dial 4.
FWD-Busy No Answer	: Dial 5.

- You may press the flexible button assigned as the FWD/DND button instead.

Voice Mail extension no.

Dial **Voice Mail extension number.**



Confirmation tone and dial tone



Hang up or press SP-PHONE/MONITOR.

<PT Display Example>

FWD(All) Extxxxx

└── VM extension number

- Calls directed to your extension are automatically forwarded to your mailbox.
- Callers can leave messages in your mailbox, according to the Voice Mail guidance.

Canceling

Any Telephone



Lift the handset or press
SP-PHONE/MONITOR.

FWD/DND

7

1

0

For PT: Press **FWD/DND**.
For any telephone: Dial **710**.

For PT

0

Dial **0**. Confirmation tone
and dial tone





Hang up or press
SP-PHONE/MONITOR.

- You may press the flexible button assigned as the FWD/DND button instead.

<PT Display Example>

FWD/DND Cancel

Listening to a stored message

You can listen to the messages stored in your mailbox easily. There are two operations to play back messages.

Using the Message Waiting (MESSAGE) button

PT

If there is a message in the mailbox, the MESSAGE indicator light is on.



Lift the handset or press
SP-PHONE/MONITOR.

MESSAGE

Press **MESSAGE**.

- You can listen to the stored message.

Manual dialing

Any Telephone



Lift the handset or press
SP-PHONE/MONITOR.

Voice Mail extension no.

Enter the **Voice Mail extension number**.

- You can listen to the stored message by following the Voice Mail guidance.

Conditions

- Outside callers can leave their messages in your mailbox. When an incoming outside call arrives, the Operator answers the call and transfers it to your extension. And...
 - If you set the "Call Forwarding" function whose destination is Voice Mail;**
The call will be forwarded to Voice Mail automatically.
 - If you do not set the "Call Forwarding" function;**
The Operator will retrieve the call. Then the Operator transfers the call to Voice Mail with Voice Mail Transfer button.
 - Voice Mail can be assigned as the destination of the following features.
 - a) Call Forwarding — All Calls
 - b) Call Forwarding — Busy
 - c) Call Forwarding — No Answer
 - d) Call Forwarding — Busy/No Answer
 - e) Intercept Routing
 - You can set the "Call Forwarding" function from an outside line following the guidance of the Voice Processing System (VPS) depending on the Panasonic VPS type.
- <PT>
- A flexible button can be assigned as the MESSAGE or FWD/DND button.

User Manual References

- 2.2.2 Flexible Button Assignment
- 4.3.8 Call Forwarding — SUMMARY
- 4.3.86 Voice Mail Transfer [PT only]

4.3.86 Voice Mail Transfer [PT only]

You can transfer the calls to the Voice Processing System so that callers can leave their messages in a desired extension mailbox. When you transfer the call to the designated extension;

—**If the extension has set the "Call Forwarding" function whose destination is Voice Mail;**

The call will be forwarded to Voice Mail.

—**If the extension has not set the "Call Forwarding" function;**

You can retrieve the call and then transfer the call to Voice Mail by One-Touch.

PT

If the call returns to you;

(VM Transfer)

extension no.

OR

phantom extension no.

OR

(DSS)

Press **Voice Mail (VM) Transfer** (flexible button).

Dial the **extension number** or the **phantom extension number** or press **DSS** (flexible button) where you left a message notification.

- The call will be forwarded to the Voice Mail.
- The caller can leave the message according to the Voice Mail guidance.

Conditions

- A flexible button can be assigned as the Voice Mail (VM) Transfer button.
- A user's Voice Mail Box number, password, etc. can be assigned as a Voice Mail Access Code.
- Through System Programming, the "VM Command DTMF Set" and "Station Hunting Type" must be programmed to match the operation of your Voice Processing System.
- Voice Mail Transfer to Phantom Mailbox:**
Allows you to transfer received outside calls to the Phantom Mailbox by entering the phantom extension number after pressing the Voice Mail Transfer button. The Phantom Message Waiting indicator light turns on. It will turn off after one of the phantom extension users listens to the stored message.

Programming Guide References

- [106] Station Hunting Type
- [113] VM Status DTMF Set
- [114] VM Command DTMF Set
- [602] Extension Group Assignment
- [609] Voice Mail Access Codes

User Manual References

2.2.2 Flexible Button Assignment

4.3.85 Voice Mail Integration

4.3.87 Walking COS

Allows you to use your calling privileges (Class of Service) at another extension. You may override restrictions which may be set at the extension.

Making a call

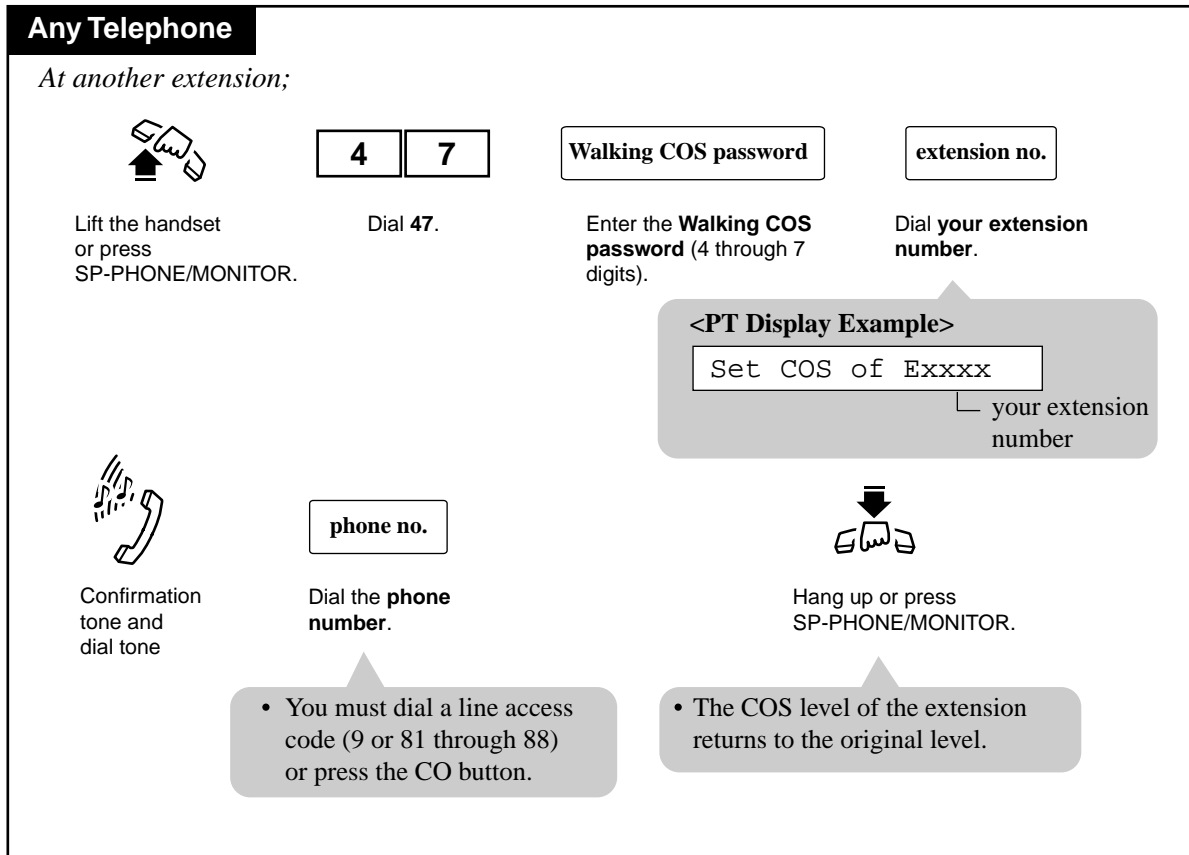

Conditions

- Class of Service (COS) programming is used to define the features which are allowed for a group of extensions. Each extension is assigned a COS number. The programmable items are as follows.
 - Outgoing call restriction level (Day mode / Night mode) – 1 through 8
 - Restriction of an outside call duration
 - Transfer a call to an outside party
 - Forward a call to an outside party
 - Executive Busy Override
 - Executive Busy Override Deny
 - Override Do Not Disturb of the called extension

- h)** Account Code Entry operation – verified – all calls / verified – to toll restriction override / option
 - i)** Off-Hook Call Announcement (OHCA)
 - j)** Access the Night / Day (Lunch / Break) Service
 - k)** The number of allowed dialing digits during an outside call
- <PT>**
- With the KX-T7431, KX-T7433, KX-T7436 or KX-T7235, you can execute this feature using the display operation.

Programming Guide References

- [121] Walking COS Password
- [601] Class of Service

Features Guide References

- Class of Service (COS)

User Manual References

- 4.5.9 KX-T7235 Display Features - System Feature Access Menu
- 4.5.12 KX-T7431 / KX-T7433 / KX-T7436 Display Features - System Feature Access Menu

4.4 Operator / Manager Service Features

4.4.1 Operator/Manager Service Features

The system supports up to two operators and one manager. An extension assigned as the Manager or an Operator by System Programming has the ability to perform the following special features:

- a) Background Music (BGM) — External
- b) Call Log Lock Control, Incoming
- c) Hotel Application — Room Status
- d) Live Call Screening Password Control^{*1}
- e) Outgoing Message (OGM)
- f) Remote Station Lock Control
- g) System Working Report
- h) Timed Reminder, Remote (Wake-Up Call)

Programming Guide References

[006] Operator / Manager Extension Assignment

^{*1} Available when the Digital Super Hybrid System is connected to a Digital Proprietary Telephone capable Panasonic Voice Processing System (one that supports digital proprietary telephone integration; e.g., KX-TVS100).

4.4.2 Background Music (BGM) — External

Allows the Manager and the Operators to broadcast background music (BGM) in the office through the external pagers.

Setting / Canceling

7235 / 7436

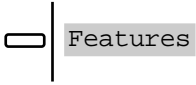

Press **Features**.

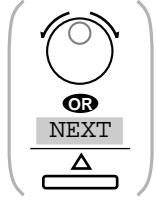

Rotate **Jog Dial** or press **NEXT** until the following is displayed.

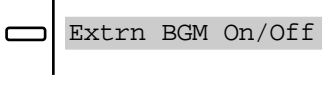

Press **Extrn BGM On/Off**.



Confirmation tone



Hang up or press **SP-PHONE**.

- Pressing this button alternates between “On” and “Off” modes.
- The display shows either one of the following depending on whether the BGM is on or off

<PT Display Example>

External BGM On

 — BGM is on

or

External BGM Off

 — BGM is off

Setting / Canceling

7431



Press **MODE** until "Feature Access" is displayed.



Rotate **Jog Dial** until "Ext-BGM On/Off" is displayed.

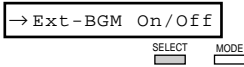

Press **SELECT**.



Confirmation tone



Hang up or press SP-PHONE.

- Pressing this button alternates between "On" and "Off" modes.
- The display shows either one of the following depending on whether the BGM is on or off

<PT Display Example>

External BGM On
— BGM is on

or

External BGM Off
— BGM is off

7433



Press **SHIFT** until "FEAT" is displayed.



Press **FEAT**.



Rotate **Jog Dial** until "Ext-BGM On/Off" is displayed.

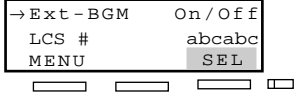

Press **SEL**.



Confirmation tone



Hang up or press SP-PHONE.

- Pressing this button alternates between "On" and "Off" modes.
- The display shows either one of the following depending on whether the BGM is on or off

<PT Display Example>

External BGM On
— BGM is on

or

External BGM Off
— BGM is off

Setting / Canceling

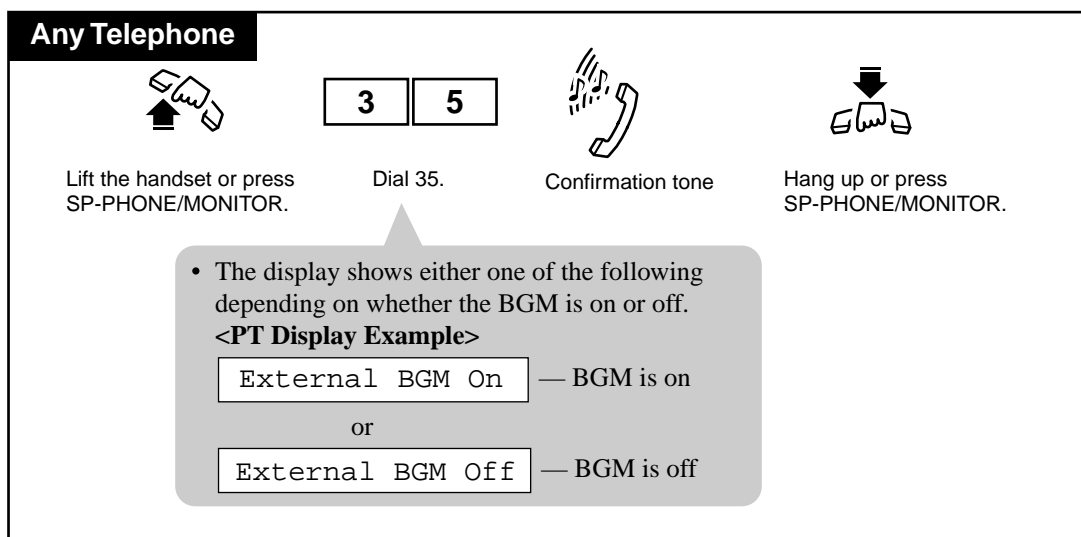

Conditions

- To make BGM-External possible, you must enable BGM and select a music source in [313] ARS Time (System Programming).
- External Pager Priority**
Priority of access to external pager is: (1) TAFAS; (2) Paging; (3) BGM
Higher priorities will override the BGM.
- The default is "External BGM Off".

Programming Guide References

[803] Music Source Use

[804] External Pager BGM

[990] System Additional Information

User Manual References

4.3.6 Background Music (BGM) [PT only]

4.4.3 Call Log Lock Control, Incoming

The Manager and the Operators can cancel the "Call Log Lock, Incoming" feature set at any other extension.

Programming

PT

PROGRAM

Press **PROGRAM**.

9 9

Dial **99**.

0 2

Dial **02**.

extension no. or *****

Dial the **extension number** or *****.

— extension number: to clear one extension
— * : to clear all extensions

- You are in the Station Programming mode:
<PT Display Example>
PT-PGM Mode

<PT Display Example>

EXT No? →

<PT Display Example>

1234:Unlock?

AUTO DIAL

STORE

Press **STORE**.

PROGRAM

Press **PROGRAM** to exit the Station Programming mode.

- The STORE indicator lights.

Conditions

- If the extension user forgets their pre-set password, they can ask the Manager or an Operator to clear the password.

User Manual References

4.5.4 Call Log Lock, Incoming (KX-T7436 / KX-T7433 / KX-T7235 / KX-T7230 only)

4.4.4 Hotel Application — Room Status (operator only)

Allows the operator to handle the front/operator service of checking the room status, ready or not ready, with the DSS button on the DSS Console paired to a KX-T7436 or KX-T7235. Changing the room status can be done by the operator and also by the telephone in a guest room.

The hotel application must be enabled by System Programming.

The DSS button indicates as follows.

Ready mode: Off

Not Ready mode: Flashes red

To check the room status

7235 / 7436

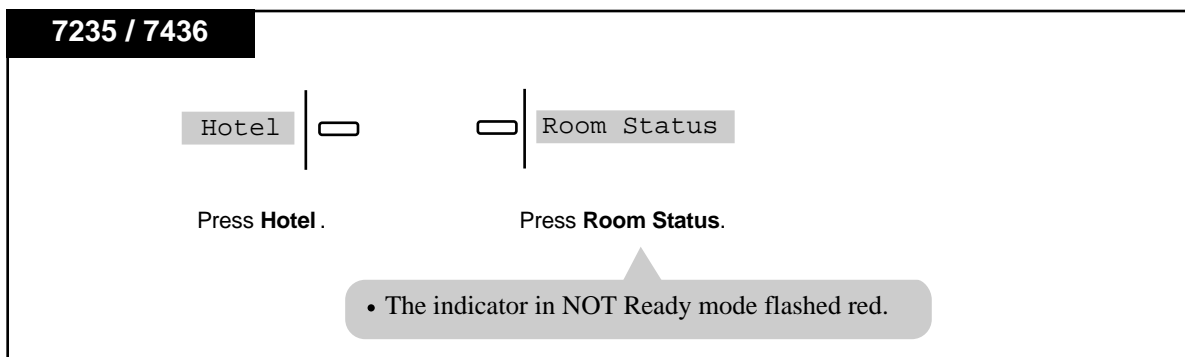

Press **Hotel**.

Press **Room Status**.

- The indicator in NOT Ready mode flashed red.

To change the room status

7235 / 7436

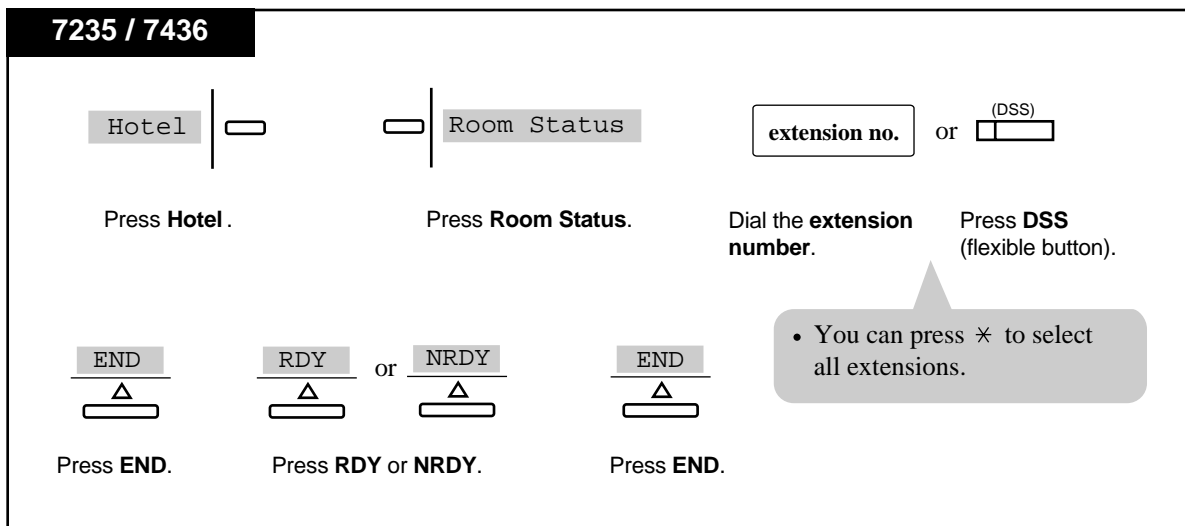

Press **Hotel**.

Press **Room Status**.

Dial the **extension number**.

Press **DSS** (flexible button).

Press **END**.

Press **RDY** or **NRDY**.

Press **END**.

- You can press * to select all extensions.

To change the room status at a telephone in a guest room

7235 / 7436

Example : If the maid finishes cleaning the room

Press **Features**. Rotate **Jog Dial** or press **NEXT** until the following is displayed.

Press **Room Status Ready**.

Confirmation tone and dial tone

Hang up or press **SP-PHONE**.

7431

Example : If the maid finishes cleaning the room

Press **MODE** until "**Feature Access**" is displayed.

Rotate **Jog Dial** until "**Room Ready**" is displayed.

Press **SELECT**.

Confirmation tone and dial tone

Hang up or press **SP-PHONE**.

7433

Example : If the maid finishes cleaning the room

Press **SHIFT** until "**FEAT**" is displayed.

Press **FEAT**.

Rotate **Jog Dial** until "**Room Ready**" is at the arrow.

Press **SEL**.

Confirmation tone and dial tone.

Hang up or press **SP-PHONE**.

Any Telephone

Example : If the maid finishes cleaning the room



Lift the handset or press
SP-PHONE/MONITOR.

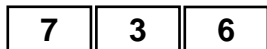

Dial **736**.



Confirmation
tone and dial
tone.



Hang up or press
SP-PHONE/MONITOR.

Conditions

- Even if the room status is changed at a telephone in a guest room, DSS button indication will not be changed automatically. It is renewed when the operator enters the checking mode again.

Programming Guide References

[134] Hotel Application

4.4.5 Live Call Screening Password Control*1

The Manager and the Operators can clear the Live Call Screening password of any extension.

Programming

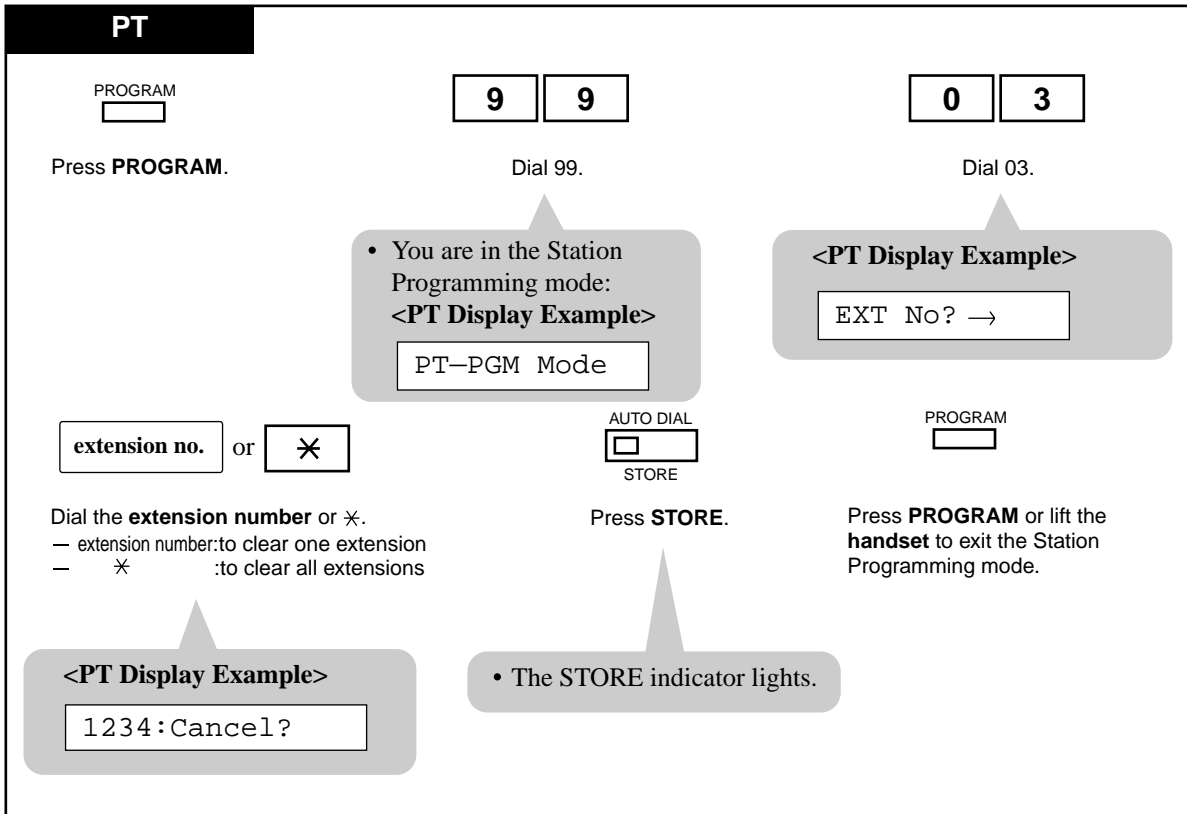

Conditions

- If the extension user forgets their pre-set password, they can ask the Manager or an Operator to clear the password.

User Manual References

4.3.50 Live Call Screening (LCS) [PT only]

*1 Available when the Digital Super Hybrid System is connected to a Digital Proprietary Telephone capable Panasonic Voice Processing System (one that supports digital proprietary telephone integration; e.g., KX-TVS100).

4.4.6 Outgoing Message (OGM)^{*1}

The Manager and the Operators can record and play back outgoing voice messages.

The following three types of outgoing messages can be recorded.

DISA message:

This message is played when an outside caller accesses the system via DISA line. There are two different DISA messages.

Timed Reminder (wake-up) message:

This message is used in Timed Reminder. When answering the Timed Reminder alarm (often used as a wake-up call), the extension user will hear this message. There is only one Timed Reminder message.

UCD (Uniform Call Distribution) message:

This message is played to the outside callers in conjunction with UCD feature. There are four different UCD messages.

^{*1} Available for the KX-TD1232 only

Recording a message

7235 / 7436

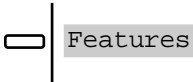

Press **Features**.

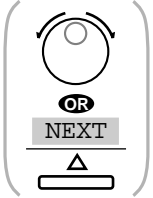

Rotate **Jog Dial** or press **NEXT** until the following is displayed.

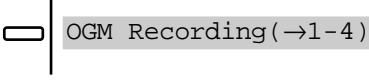

Press **OGM Recording**.



Enter **OGM number** (1 through 4).



Confirmation tone



Record a message.



Press **STORE** or wait until a maximum recording time has elapsed.

<PT Display Example>

OGM 2
Rec.:00

Time counter (seconds)

OGM number selected (1 through 4)

- The STORE indicator light flashes red slowly. Recording starts after the confirmation tone.

- The recording is stopped and STORE indicator light turns steady red.
- The recorded message will be played back automatically.

<PT Display Example>

OGM 2
Play:28



Confirmation tone



Press **STORE** or wait until playback is finished.



Confirmation tone



Hang up or press **SP-PHONE**.

- The STORE indicator light turns off.

288

User Manual

Recording a message

7431



Press **MODE** until "Feature Access" is displayed.



Rotate **Jog Dial** until "OGM Record" is displayed.



Press **SELECT**.



Enter **OGM number** (1 through 4).



Confirmation tone



Record a message.



Press **STORE** or wait until a maximum recording time has elapsed.

<PT Display Example>

OGM 2 Rec.:00

Time counter (seconds)
OGM number selected (1 through 4)

- The STORE indicator light flashes red slowly. Recording starts after the confirmation tone.

- The recording is stopped and STORE indicator light turns steady red.
- The recorded message will be played back automatically.

<PT Display Example>

OGM 2 Play:28



Confirmation tone



Press **STORE** or wait until playback is finished.



Confirmation tone



Hang up or press **SP-PHONE**.

- The STORE indicator light turns off.

Recording a message

7433



Press **SHIFT** until "FEAT" is displayed.



Press **FEAT**.



Rotate **Jog Dial** until "OGM Record" is at the arrow.



Press **SEL**.



Enter **OGM number** (1 through 4).



Confirmation tone



Record a message.



Press **STORE** or wait until a maximum recording time has elapsed.

<PT Display Example>

OGM 2 Rec. : 00

Time counter (seconds)
OGM number selected (1 through 4)

- The STORE indicator light flashes red slowly. Recording starts after the confirmation tone.

- The recording is stopped and STORE indicator light turns steady red.
- The recorded message will be played back automatically.

<PT Display Example>

OGM 2 Play: 28



Confirmation tone



Press **STORE** or wait until playback is finished.



Confirmation tone



Hang up or press **SP-PHONE**.

- The STORE indicator light turns off.

Recording a message

Any Telephone



Lift the handset or press
SP-PHONE/MONITOR.

3	6	1
---	---	---

Dial 361.

OGM no.

Enter OGM number
(1 through 4).



Confirmation
tone

<PT Display Example>

OGM 2	Rec.: 00
-------	----------

Time counter
(seconds)

OGM number
selected
(1 through 4)

- The STORE indicator light flashes red slowly
Recording starts after the confirmation tone.



Record a message.

AUTO DIAL

 STORE

Press **STORE** or wait until
a maximum recording time
has elapsed.



Confirmation
tone

- The recording is stopped and STORE indicator light turns steady red.
- The recorded message will be played back automatically.

<PT Display Example>

OGM 2	Play: 28
-------	----------

AUTO DIAL

 STORE

Press **STORE** or wait until
playback is finished



Confirmation
tone



Hang up or press
SP-PHONE/MONITOR.

- The STORE indicator light turns off.

Playing back a message

7235 / 7436

Press **Features**.

Rotate **Jog Dial** or press **NEXT** until the following is displayed.

Press **OGM Playback (→1-4)**.

Press **OGM Playback**.

Enter **OGM number** (1 through 4).

Confirmation tone

Press **STORE** or wait until playback is finished.

Confirmation tone

- The **STORE** indicator light turns off.

<PT Display Example>

OGM 1 Play: 28

Time counter (seconds)

- The **STORE** indicator lights.
- The message is played back and the counter starts.

Playing back a message

7431

MODE

Press **MODE** until "Feature Access" is displayed.

Jog Dial

Rotate **Jog Dial** until "OGM Play" is displayed.

OGM Play 1-4

Press **SELECT**.

OGM no.

Enter **OGM number** (1 through 4).

AUTO DIAL STORE

Press **STORE** or wait until playback is finished.

Confirmation tone

Confirmation tone

- The STORE indicator light turns off.

<PT Display Example>

OGM 1 Play:28

Time counter (seconds)

- The STORE indicator lights.
- The message is played back and the counter starts.

Playing back a message

7433



Press **SHIFT** until "FEAT" is displayed.



Press **FEAT**.



Rotate **Jog Dial** until "OGM Play" is at the arrow.



Press **SEL**.



Enter **OGM number** (1 through 4).



Confirmation tone



Press **STORE** or wait until playback is finished.



Confirmation tone

- The STORE indicator light turns off.

<PT Display Example>

OGM 1 Play: 28

Time counter (seconds)

- The STORE indicator lights.
- The message is played back and the counter starts.

Playing back a message

Any Telephone



Lift the handset or press
SP-PHONE/MONITOR.

3	6	2
---	---	---

Dial **362**.

OGM no.

Enter **OGM number**
(1 through 4).



Confirmation tone

AUTO DIAL
<div style="border: 1px solid black; width: 20px; height: 10px; margin: 0 auto;"></div>
STORE

Press **STORE** or wait until
playback is finished.



Confirmation tone

<PT Display Example>

OGM 1	Play:28
-------	---------

Time counter (seconds)

- The STORE indicator lights.
- The message is played back and the counter starts.

- The STORE indicator light turns off.

Conditions

- OGM Type**
 - 1: for DISA Message 1 or UCD Message 1
 - 2: for DISA Message 2 or UCD Message 2
 - 3: for Timed Reminder Message or UCD Message 3
 - 4: UCD Message 4
- You can select a maximum recording time of 0/16/32/64 seconds for each message (Outgoing Message Time). The total length must be under sixty four seconds.

Programming Guide References

[215] Outgoing Message Time

User Manual References

- 4.3.34 Direct Inward System Access (DISA)
- 4.3.78 Timed Reminder
- 4.3.84 Uniform Call Distribution (UCD)

4.4.7 Remote Station Lock Control

The Manager and the Operators can remotely lock or unlock any extension. To lock an extension, you can select to lock outside calls or intercom calls.

Programming

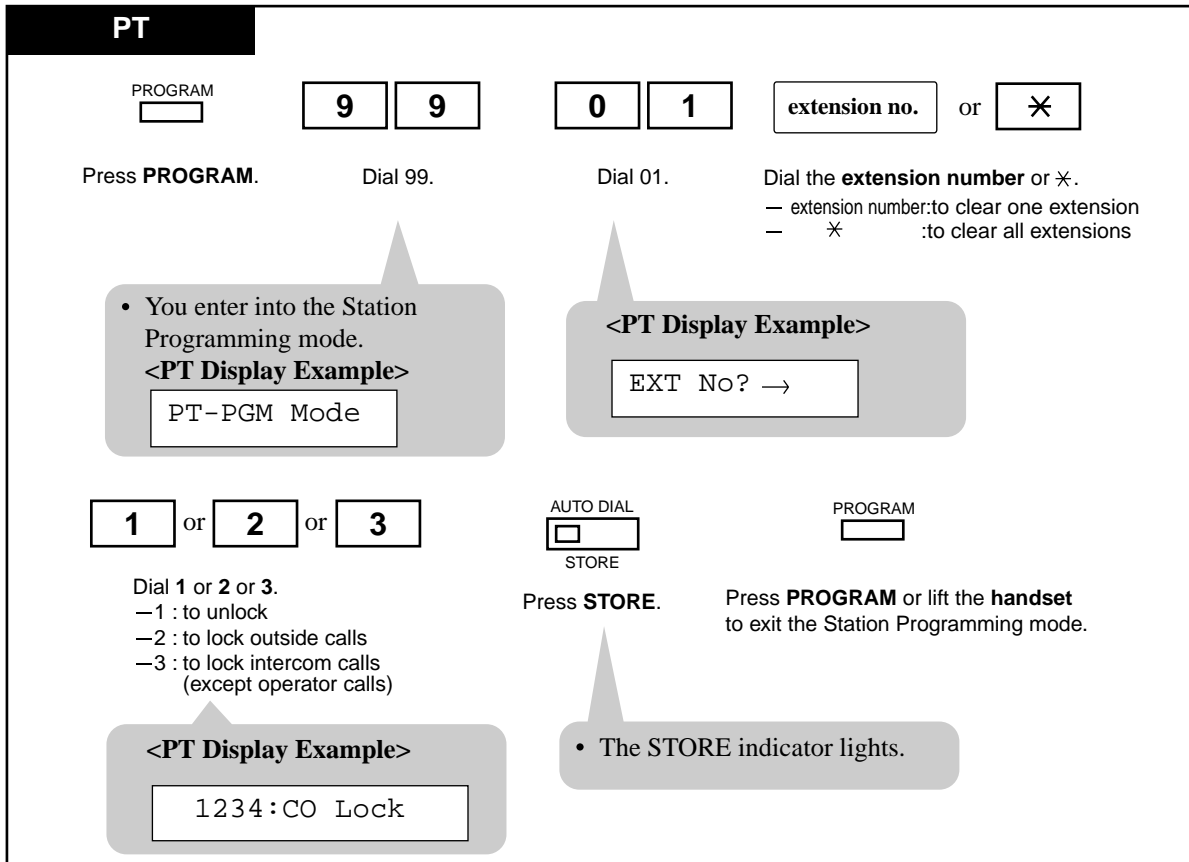

Conditions

- This feature supersedes the "Electronic Station Lockout" feature. If "Electronic Station Lockout" has already been set by the extension user and this feature is set, the extension user cannot cancel the lock. Only the Manager and the Operators can cancel the lock.
- "Operator Call" is always available from any extension whether it is locked or not.

User Manual References

4.3.38 Electronic Station Lockout

4.4.8 System Working Report

The operator or manager can print or clear the system working report. For details about the recorded contents, please consult with your dealer.

7235 / 7436

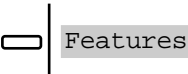

Press **Features**.



Press **NEXT** until the following is displayed.

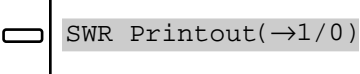

Press **SWR Printout**.

1

 or

0

Dial **1** or **0**.
 – **1**: to print out the data
 – **0**: to clear the date



Confirmation tone and dial tone



Hang up or press SP-PHONE.

<PT Display Example>

SWR Data Dump	– 1 : to print out
SWR Data Clear	– 0 : to clear

7431



Press **MODE** until "Feature Access" is displayed.



Rotate **Jog Dial** until "SWR Print" is displayed.

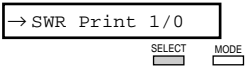

Press **SELECT**.

1

 or

0

Dial **1** or **0**.
 – **1**: to print out the data
 – **0**: to clear the data



Confirmation tone and dial tone



Hang up or press SP-PHONE.

<PT Display Example>

SWR Data Dump	– 1 : to print out
SWR Data Clear	– 0 : to clear

7433



Press **SHIFT** until "FEAT" is displayed.



Press **FEAT**.



Rotate **Jog Dial** until "SWR Printout" is at the arrow.

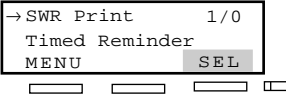

Press **SEL**.

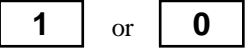

Dial **1** or **0**.
 - **1**: to print out the data
 - **0**: to clear the data



Confirmation tone and dial tone



Hang up or press SP-PHONE.

<PT Display Example>

SWR Data Dump	- 1 : to print out
SWR Data Clear	- 0 : to clear

Any Telephone



Lift the handset or press SP-PHONE /MONITOR.



Dial 794.

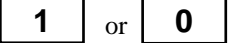

Dial **1** or **0**.
 - **1**: to print out the data
 - **0**: to clear the data



Confirmation tone and dial tone



Hang up or press SP-PHONE /MONITOR.

<PT Display Example>

SWR Data Dump	- 1 : to print out
SWR Data Clear	- 0 : to clear

Conditions

- A printer connected to the Serial Interface (RS-232C) connector can be used to print the recorded data.
- If the recorded data is cleared, new data will be recorded.

Features Guide References

System Working Report

4.4.9 Timed Reminder, Remote (Wake-Up Call)

The Manager and the Operators can remotely set or cancel the Timed Reminder to the desired extension.

Setting

7235 / 7436

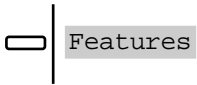

Press **Features**.

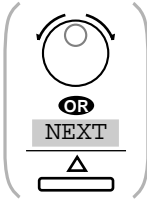

Rotate **Jog Dial** or press **NEXT** until the following is displayed.

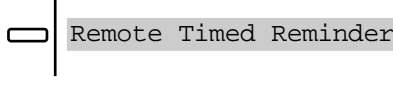

Press **Remote Timed Reminder**.

<PT Display Example>

Extension #:

extension no. or (DSS)

Dial the desired **extension number** or press **DSS** (flexible button).

S1 S2 S3 NEXT

Press **NEXT (S3)**.

hour

Enter the **hour** (01 through 12).

minute

Enter the **minute** (00 through 59).

0 or 1

For AM: Dial **0**.
For PM: Dial **1**.

<PT Display Example>

Extension #:xxxx — (xxxx: extension number)

Time(hh:mm): :

AM/PM(0/1) :

Daily Y/N(1/0):0

0 or 1

For one time alarm*1: Dial 0.
For daily alarm*2: Dial 1.

S1 S2 S3 PROG

Press **PROG(S3)**



Confirmation tone and dial tone



Hang up or press **SP-PHONE**.

*1 You hear an alarm ringing at the preset time and then the setting is cleared.

*2 You hear an alarm ringing daily at the preset time until the setting is changed or canceled.

<PT Display Example>

Alarm 01:00AM – only one time

Alarm 01:00AM* – daily

Setting

7431



Press **MODE** until "Feature Access" is displayed.



Rotate **Jog Dial** until "R-Timed Remind" is displayed.

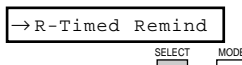

Press **SELECT**.



Dial **1**.

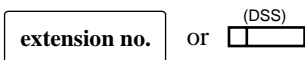

Dial the desired **extension number** or press **DSS** (flexible button).



Enter the **hour** (01 through 12).



Enter the **minute** (00 through 59).

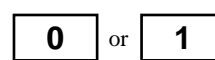

For AM: Dial **0**.
For PM: Dial **1**.

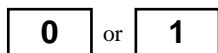

For one time alarm*¹: Dial **0**.
For daily alarm*²: Dial **1**.



Confirmation tone and dial tone



Hang up or press SP-PHONE.

*¹ You hear an alarm ringing at the preset time and then the setting is cleared.
*² You hear an alarm ringing daily at the preset time until the setting is changed or canceled.

<PT Display Example>

Alarm 01:00AM	– only one time	Alarm 01:00AM*	– daily
---------------	-----------------	----------------	---------

Setting

7433



Press **SHIFT** until "FEAT" is displayed.



Press **FEAT**.



Rotate **Jog Dial** until "R-Timed Remind" is at the arrow.

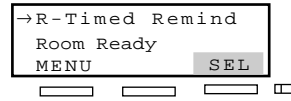

Press **SEL**.

1

Dial **1**.

extension no.

Dial the desired **extension number** or press **DSS** (flexible button).

OR **(DSS)**

hour

Enter the **hour** (01 through 12).

minute

Enter the **minute** (00 through 59).

0

OR **1**

For AM: Dial **0**.
For PM: Dial **1**.

0

OR **1**

For one time alarm*¹: Dial **0**.
For daily alarm*²: Dial **1**.



Confirmation tone and dial tone



Hang up or press SP-PHONE.

*¹ You hear an alarm ringing at the preset time and then the setting is cleared.

*² You hear an alarm ringing daily at the preset time until the setting is changed or canceled.

<PT Display Example>

Alarm 01:00AM – only one time

Alarm 01:00AM* – daily

Setting

Any Telephone



Lift the handset or press SP-PHONE/MONITOR.

7

*

1

Dial 7*1.

extension no.

 or ^(DSS)

Dial the desired **extension number** or press **DSS**.

hour

Enter the **hour** (01 through 12).

minute

Enter the **minute** (00 through 59).

0

 or

1

For AM: Dial **0**.
For PM: Dial **1**.

0

 or

1

For a one time alarm*¹: Dial **0**.
For a daily alarm*²: Dial **1**.



Confirmation tone and dial tone



Hang up or press SP-PHONE/MONITOR.

*¹ You hear an alarm ringing at the preset time and then the setting is cleared.
*² You hear an alarm ringing daily at the preset time until the setting is changed or canceled.

<PT Display Example>

Alarm
01:00AM
–
only one time

Alarm
01:00AM*
–
daily

Canceling

7235 / 7436



Features

Press **Features**.

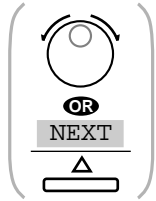

Rotate **Jog Dial** or press **NEXT** until the following is displayed.



Remote Timed Reminder

Press **Remote Timed Reminder**.

<PT Display Example>

Extension #:

extension no.

 or (DSS)

NEXT

CLR



Confirmation tone

S1

S2

S3

S1

S2

S3

<PT Display Example>

Extension #:1234

Time(hh:mm):07:00

AM/PM(0/1) :0

Daily Y/N(1/0):0



Hang up or press the SP-PHONE.

Canceling

7431



 **MODE**

Press **MODE** until **"Feature Access"** is displayed.

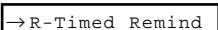

Rotate **Jog Dial** until **"R-Timed Remind"** is displayed.



 → R-Timed Remind

Press **SELECT**.

 **0**

Dial **0**.

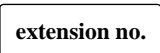
 **extension no.** or  **(DSS)**

Dial the desired **extension number** or press **DSS** on which you have set the Timed Reminder.



Confirmation tone and dial tone



Hang up or press the **SP-PHONE**.

<PT Display Example>

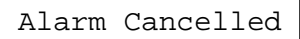
 **Alarm Cancelled**

Canceling

7433



Press **SHIFT** until "FEAT" is displayed.



Press **FEAT**.



Rotate **Jog Dial** until "R-Timed Remind" is at the arrow.

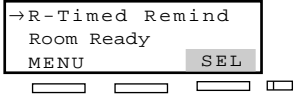

Press **SEL**.



Dial **0**.

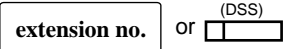

Dial the desired **extension number** or press **DSS** on which you have set the Timed Reminder.



Confirmation tone and dial tone



Hang up or press the SP-PHONE.

<PT Display Example>

Alarm Cancelled

Any Telephone



Lift the handset or press SP-PHONE/MONITOR.



Dial **7*0**.

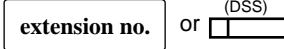

Dial the desired **extension number** or press **DSS** on which you have set the Timed Reminder.



Confirmation tone and dial tone



Hang up or press SP-PHONE/MONITOR.

<PT Display Example>

Alarm Cancelled

Checking the time setting

Display PT



Lift the handset or press
SP-PHONE.

7

*

2

Dial 7*2.

extension no.

or

(DSS)



Hang up or press
SP-PHONE.

<PT Display Example>

- If "10:10" has been set, the display shows;

Alarm 10:10AM

– only one time

Alarm Not Stored
- If time setting is not stored.

or

Alarm 10:10AM*

– daily

Conditions

- The system clock must be set correctly beforehand.
- There is no limit to the number of the extensions who can set the Timed Reminder at the same time.
- Only the latest time setting is valid at the extension whether it was set by the extension user (Timed Reminder) or by the Manager extension or an Operator (Timed Reminder, Remote).
- **Station Message Detail Recording (SMDR)**
SMDR automatically records the detailed Timed Reminder information (date, time, extension number, start/no answer). It is programmable to be printed out when the Timed Reminder starts and the alarm is not answered. Refer to "Station Message Detail Recording (SMDR)" in the Features Guide for further information.

Programming Guide References

- [000] Date and Time Set
- [217] Timed Reminder Alarm Ring Time
- [990] System Additional Information

User Manual References

- 4.3.78 Timed Reminder

4.5 Special Display Features

4.5.1 Special Display Features

With the display telephone, KX-T7230, KX-T7235, KX-T7431, KX-T7433 or KX-T7436, you can easily access several features.

The display telephones have the ability to perform the following features.

Feature	KX-T7230	KX-T7235	KX-T7431	KX-T7433	KX-T7436
Call Forwarding / Do Not Disturb		✓			✓
Call Log, Incoming	✓	✓		✓	✓
Call Log Lock, Incoming	✓	✓		✓	✓
Call Log, Outgoing		✓			✓
Call Monitoring in Station Hunting		✓			✓
Call Directory					
Extension Dialing		✓	✓	✓	✓
Station Speed Dialing		✓	✓	✓	✓
System Speed Dialing		✓	✓	✓	✓
System Feature Access Menu		✓	✓	✓	✓

" ✓ " indicates the feature is available.

Helpful Information about Display Operation

Press **CONT** (S1) to adjust the display contrast.

Press **RING** (S2) to adjust the ringer volume.

Press **BGM** (S3) to turn on/off the BGM.

Press **MENU** (S1) to return to the initial display.

Press **PREV** (S2) to return to the previous display.

Press **NEXT** (S3) to advance to the next display.

Press **ACCNT** (S3) to enter an account code.

4.5.2 Call Forwarding / Do Not Disturb (KX-T7436 / KX-T7235 only)

You can set or cancel the Call Forwarding and Do Not Disturb features using the display.

Features on the First Display

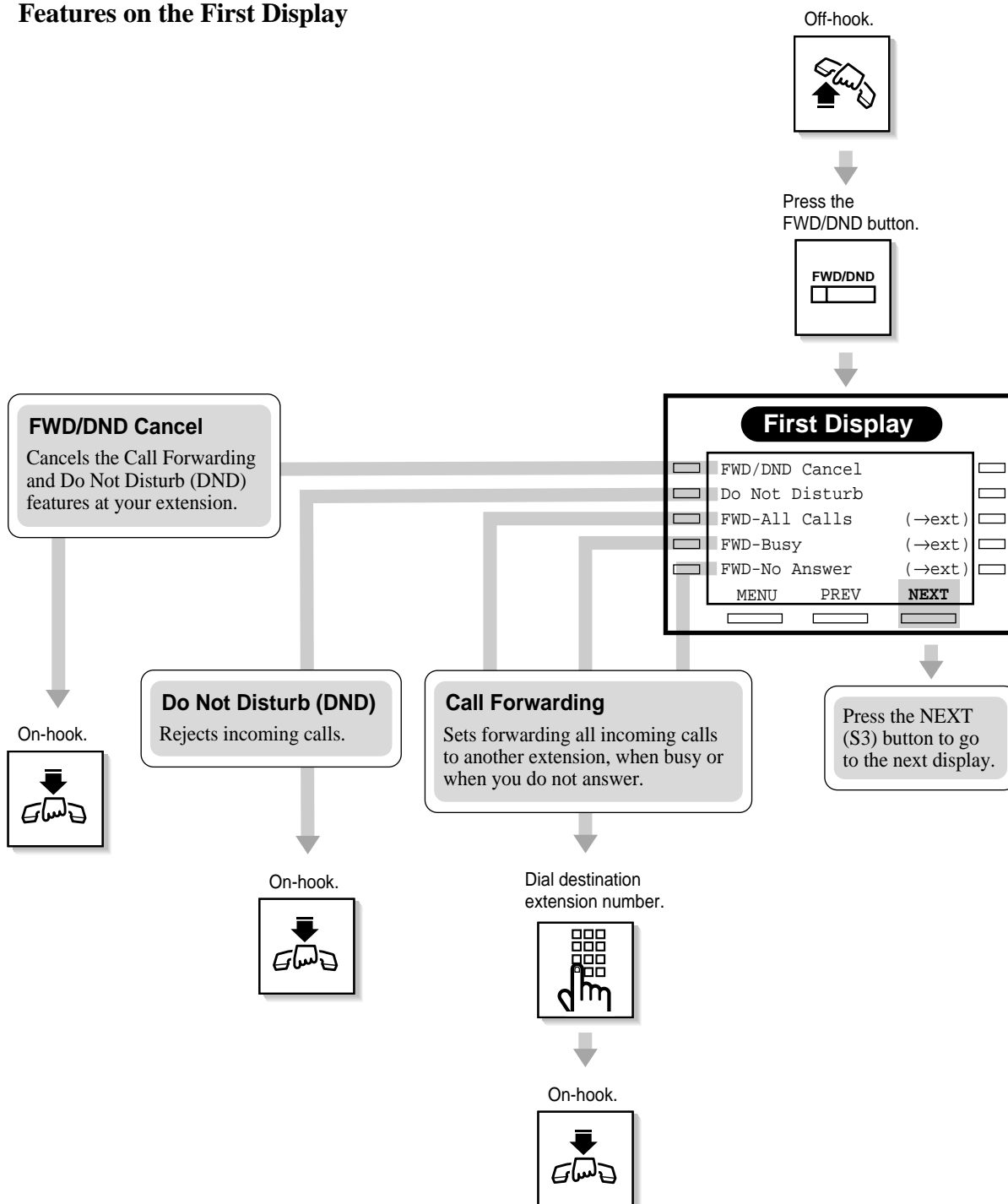

Features on the Second Display

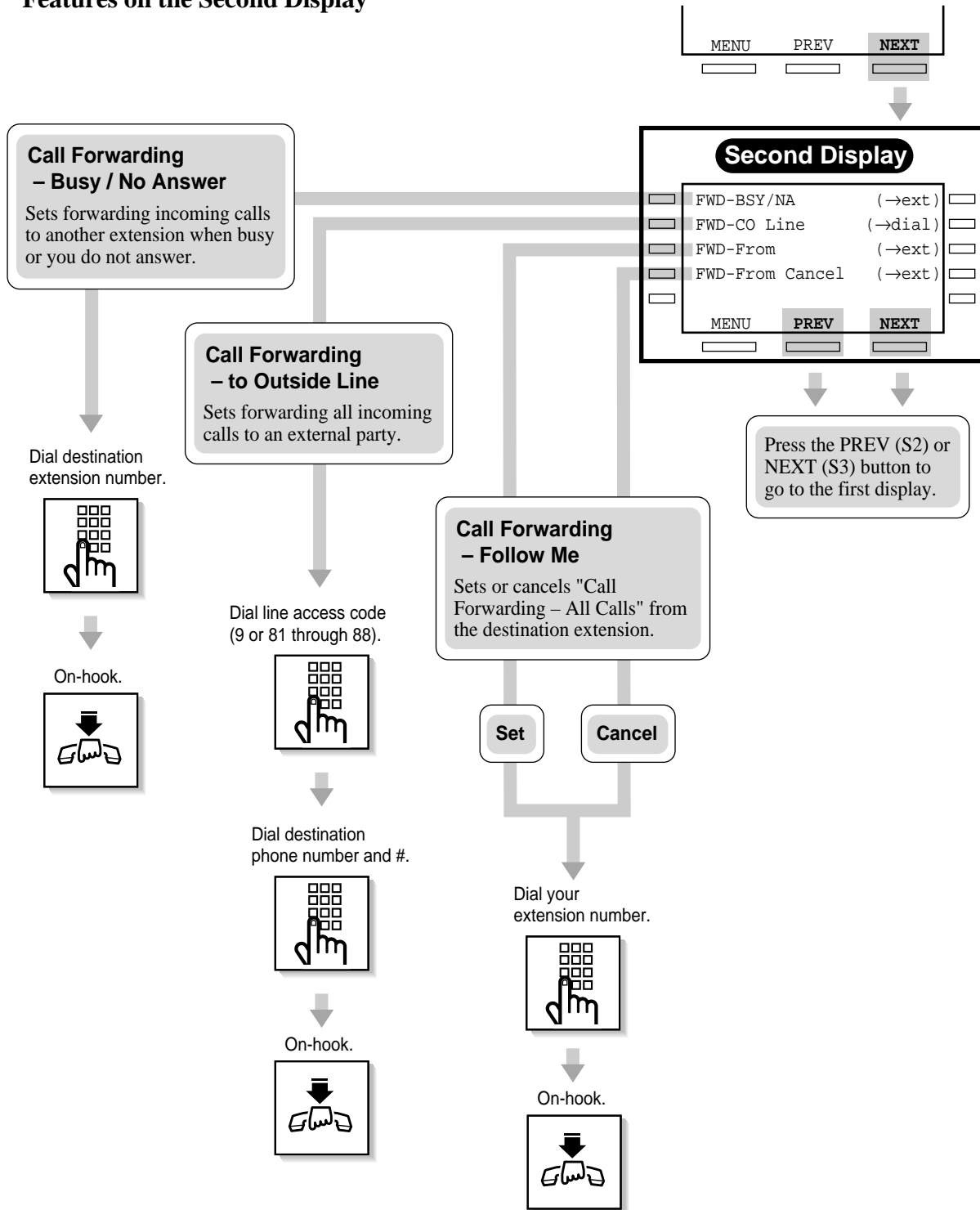

4.5.3 Call Log, Incoming (KX-T7436 / KX-T7433 / KX-T7235 / KX-T7230 only)

If you do not answer an incoming outside call, your extension automatically records the call information from the Caller ID service^{*1}, and the SHIFT button indicator lights. Up to 30 calls can be logged per extension. When the call log is full (30 calls are stored), you can select how the 31st call is treated. Either a new call can be disregarded or the new call overwrites the oldest call. (Default: Record the new call.)

You can also modify the logged numbers for callback purpose.

Setting overwriting the call log

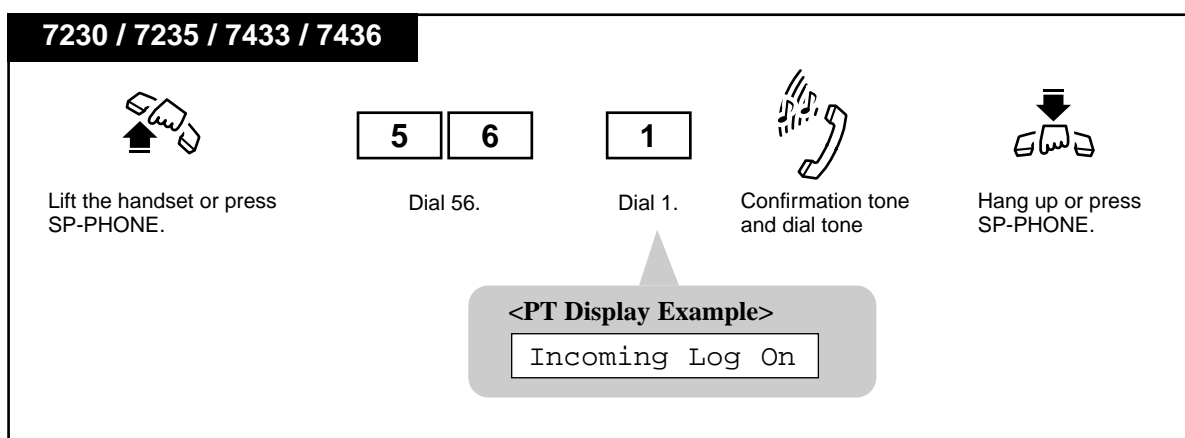

Canceling overwriting the call log (Disregarding the 31st call)

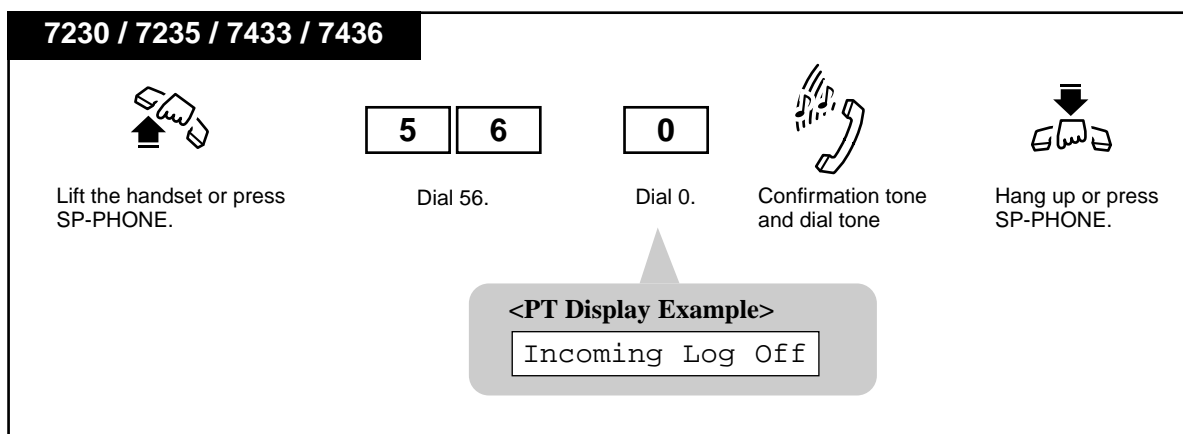

^{*1} The Caller ID service provides you with a caller's information, such as his/her name and telephone number, on the outside line assigned to receive Caller ID service calls. Refer to "Caller ID Service" in the Features Guide for further information.

Logging a call information while talking

KX-T7433 / KX-T7230

While receiving an incoming outside call, the display shows the caller's telephone number and name.

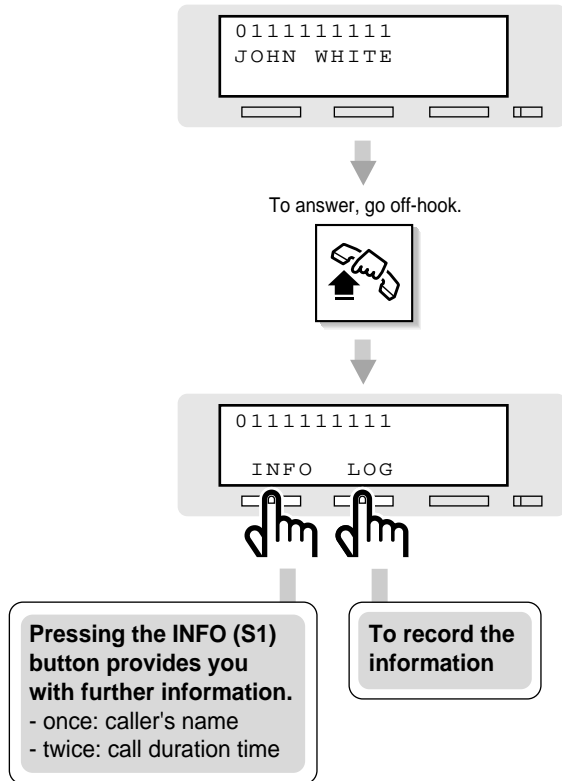

Operating sequence

1. To answer the call, **go off-hook**.
2. Press the **LOG** (S2) button to log the information. Or press the **INFO** (S1) button repeatedly to see the information in detail.

KX-T7436 / KX-T7235

While receiving an incoming outside call, the display shows the caller's telephone number and name.

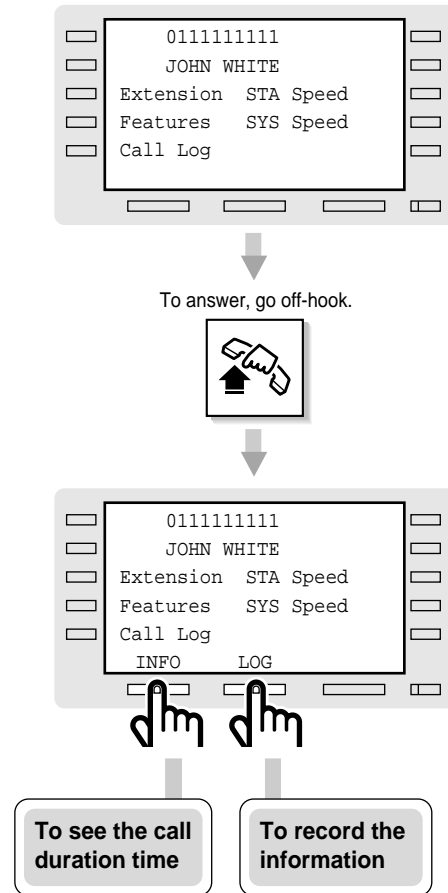

Note

- Pressing the SHIFT button before answering a call provides you with more information about the caller, outside line number and/or name.
- You can select either the initial display, Caller ID or outside line name, by Station Programming.
- After going off-hook, you can press the SHIFT button to change the bottom line on the display as follows: CONT EFA ACCNT

Confirming and calling back

When the SHIFT indicator is red, there are calls logged.

KX-T7433 / KX-T7230

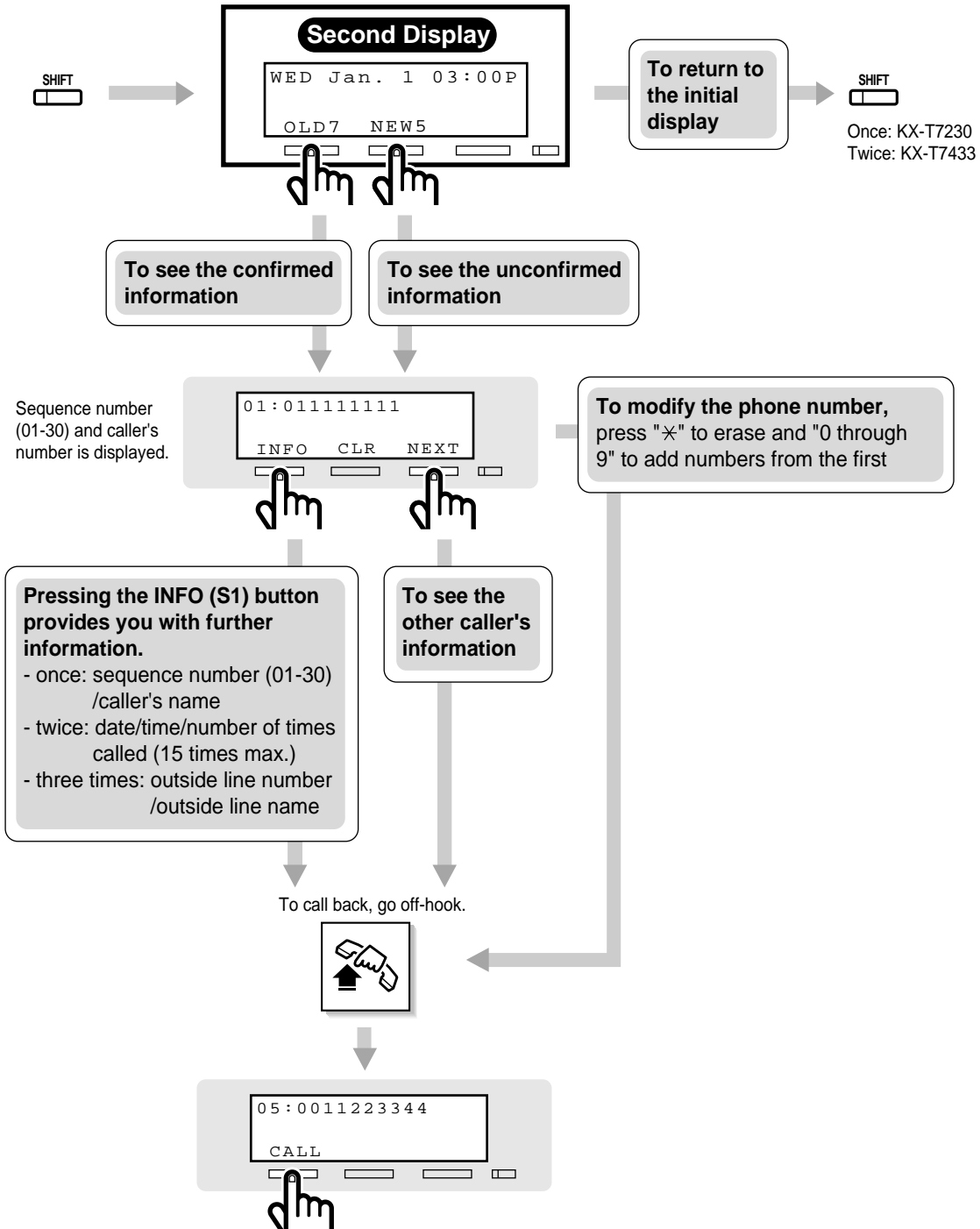

Operating sequence

1. Press the **SHIFT** button.
2. Press the **OLD** (S1) or **NEW** (S2) button to see the confirmed or unconfirmed information.
3. Press the **NEXT** (S3) or **PREV** (S3) button to see other caller's information. Or press the **INFO** (S1) button repeatedly to see the information in detail. Or **modify the number**, if required.
4. To call back, **go off-hook** and then press the **CALL** (S1) button.

Note

- To delete the displayed number, press the CLR (S2) button.
- The PREV (S3) and EXIT (S1) button appears by pressing the SHIFT button while confirming. The EXIT (S1) button is used to return to the initial display.
- When a new call is logged, the display changes to the second display automatically.

Operating sequence

1. Press the **SHIFT** button.
2. Press the **OLD** (S1) or **NEW** (S2) button to see the confirmed or unconfirmed information.
3. Press the **NEXT** (S3) or **PREV** (S3) button to see other caller's information. Or **modify the number**, if required.
4. To call back, **go off-hook** and then press the **CALL** (S1) button.

Note

To delete the displayed number, press the CLR (S2) button.
The PREV (S3) button appears by pressing the SHIFT button while confirming.
When a new call is logged, the display changes to the second display automatically.

Conditions

- If a Direct In Lines (DIL) 1 : 1 call is forwarded by Call Forwarding, the data will be logged at both the forwarding and forwarded extension.
- You can lock the display so that incoming call information is not shown on the display.
- If you modify the displayed telephone number, the new number will be memorized.
- With the KX-T7433, KX-T7436 or KX-T7235, you can set or cancel overwriting the call log using the display operation.

Programming Guide References

- [100] Flexible Numbering
- [406] Caller ID Assignment
- [417] Outside Line Name Assignment

User Manual References

- 2.2.1 Initial Settings
- 4.5.4 Call Log Lock, Incoming (KX-T7436 / KX-T7433 / KX-T7235 / KX-T7230 only)
- 4.5.9 KX-T7235 Display Features - System Feature Access Menu
- 4.5.12 KX-T7431 / KX-T7433 / KX-T7436 Display Features - System Feature Access Menu

4.5.4 Call Log Lock, Incoming (KX-T7436 / KX-T7433 / KX-T7235 / KX-T7230 only)

Allows you to lock the display of your extension so that the "Call Log, Incoming" feature is not shown on the display, if you do not want others to see the information.

Locking

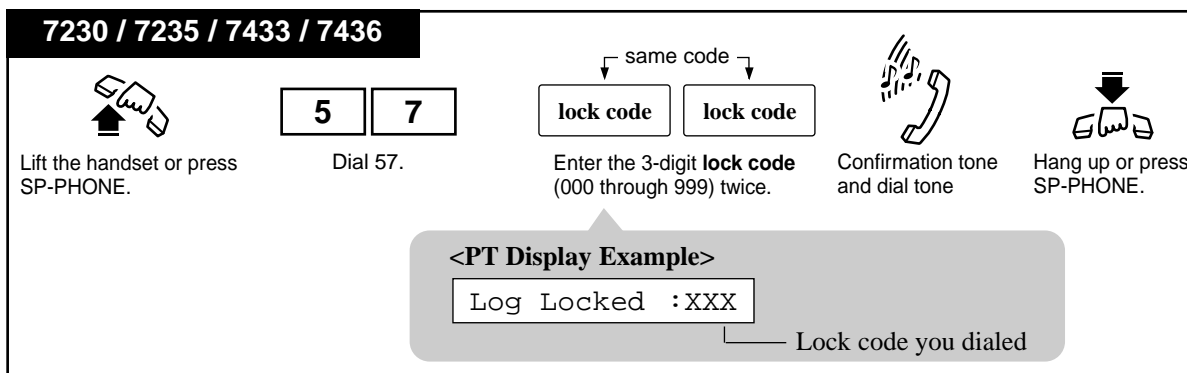

Unlocking

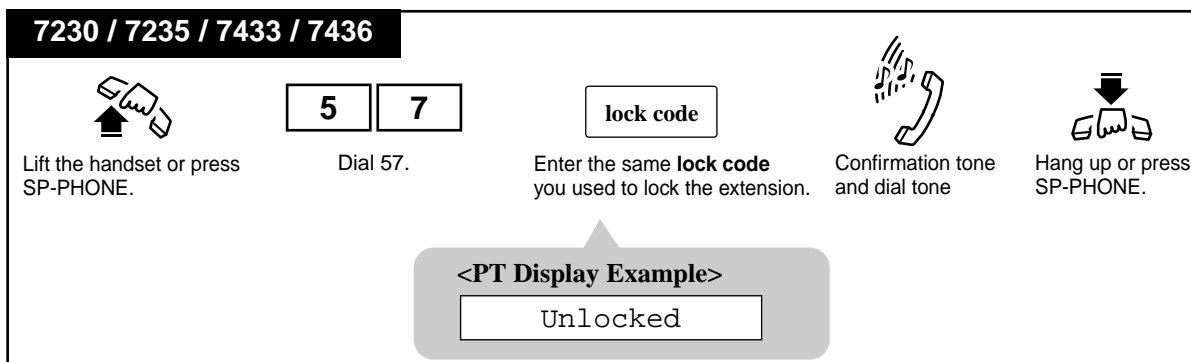

Conditions

- **Call Log Lock Control, Incoming**
The Manager or an Operator can unlock the call log display for any extension, if you forget your lock code (Call Log Lock Control, Incoming).
- With the KX-T7433, KX-T7436 or KX-T7235, you can execute this feature using the display operation.

Programming Guide References

- [100] Flexible Numbering
- [406] Caller ID Assignment

User Manual References

- 4.4.3 Call Log Lock Control, Incoming
- 4.5.3 Call Log, Incoming (KX-T7436 / KX-T7433 / KX-T7235 / KX-T7230 only)
- 4.5.9 KX-T7235 Display Features - System Feature Access Menu
- 4.5.12 KX-T7431 / KX-T7433 / KX-T7436 Display Features - System Feature Access Menu

4.5.5 Call Log, Outgoing (KX-T7436 / KX-T7235 only)

Last five CO calls you made are automatically logged. You can make a call using the call log.

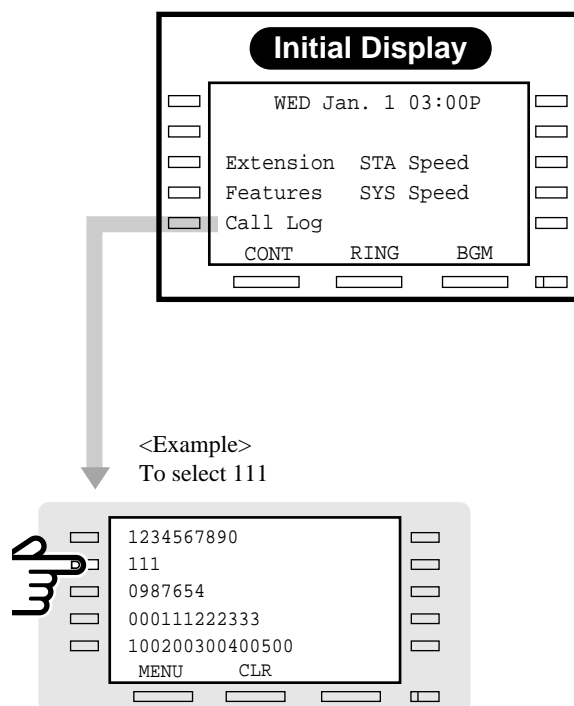

Making a call using a call log

1. Press the **Call Log** (F5) button.
2. Press the **Function** button which is next to the desired number.

Note

- To delete all numbers, press the CLR (S2) button.
- To return to the initial display, press the MENU (S1) button.

4.5.6 Call Monitoring in Station Hunting (KX-T7436 / KX-T7235 only)

You can monitor the information of incoming outside calls waiting in the extension groups and confirm how the calls have been treated. Up to eight extension users can monitor simultaneously. This feature is only available for specified extensions pre-assigned by System Programming. For details, consult your manager or dealer.

Monitoring

7235 / 7436

While on-hook

SHIFT

Press **SHIFT** until "MNTR" is displayed.

MNTR

Press "MNTR"*2

group no. Specific
or
***** All

Enter specific **extension group number** (1-8) or ***** for all.

DISP

Press "DISP".

<PT Display Example>

Group 2	Waiting 002	---	Extension Group no. (1-8, *(*: all)) / Waiting calls (000-255)
Total Arrived	00020	---	Total of received calls (00000-65535)
Total Answered	00010	---	Total of answered calls (00000-65535)
Total Overflow	00002	---	Total of transferred calls (00000-65535)
Total Lost	00002	---	Total of disconnected waiting calls (00000-65535)
MENU	CLR	MNTR*2	

If you enter a group number except UCD/Ring Group*1 number or "0", you hear the error tone. Re-enter the proper number.

Clearing the number of calls

7235 / 7436

CLR

Press "CLR".

Clear Total Call OK?

Press "YES".

<PT Display Example>

Group 2	Waiting 002	
Total Arrived	00002	
Total Answered	00000	
Total Overflow	00000	
Total Lost	00000	
MENU	CLR	MNTR*2

Conditions

- When receiving a call, the monitoring display also remains with the flashing CO button and ringing.
- When entering * for all, total calls of all groups is displayed.
- When the night mode is switched to the day mode, "Total Call" can be cleared automatically by programming. For more details, consult your manager or dealer.
- *1 For more details about these groups, consult your manager or dealer.

320

User Manual

- *2 When set by System Programming, "MNTR" will be displayed. For more details, consult your manager or dealer.

Helpful hints

- To return to the initial display, press the MENU (S1) button or go off-hook and on-hook.
- To go to the next/previous group number, rotate the Jog Dial or press the UP/DOWN button instead of entering the group number. In this case, all group number "*" is not displayed.

Programming Guide References

- [991] COS Additional Information

Features Guide References

- Call Monitoring in Station Hunting

4.5.7 KX-T7235 Display Features

The KX-T7235 telephone allows you to make a call or operate the features using the display message with the Function buttons.

1) Call Directory

- Extension Dialing
- Station Speed Dialing
- System Speed Dialing

2) System Feature Access Menu

The System Feature Access Menu provides a display of the system features which appear in alphabetical order. The available features are as follows:

Absent Message Capability	Message Waiting
Automatic Callback Busy (Camp-On), Cancel	Night / Day (Lunch / Break) Service
Background Music (BGM) — External	Outgoing Message (OGM)
Call Log, Incoming	Paging — External
Call Log Lock Incoming	Paging — Group
Call Park	Paging — ANSWER
Call Pickup, Directed	Paging — DENY
Call Pickup, Group	Paralleled Telephone Connection
Call Pickup, Outside Line	Pickup Dialing (Hot Line)
Call Pickup Deny	Station Program Clear
Call Waiting	System Working Report
Data Line Security	Timed Reminder
Door Opener	Timed Reminder, Remote (Wake-Up Call)
Doorphone Call	Walking COS
Electronic Station Lockout	
Executive Busy Override Deny	
Hotel Application — Room Status (from a guest room)	
Live Call Screening (LCS), Password Set	
Log-In / Log-Out	

3) Hotel Application

The display message for the Hotel Application appears only when it is enabled in system programming.

Programming Guide References

- [001] System Speed Dialing Number Set
- [002] System Speed Dialing Name Set
- [003] Extension Number Set
- [004] Extension Name Set
- [012] ISDN Extension Number Set
- [013] ISDN Extension Name Set
- [134] Hotel Application

User Manual References

- 2.2.8 Station Speed Dialing Number/Name Assignment [KX-T7235/KX-T7431/KX-T7433/KX-T7436 only]
- 3.2.2 [001] System Speed Dialing Number Set
- 3.2.3 [002] System Speed Dialing Name Set
- 3.2.4 [003] Extension Number Set
- 3.2.5 [004] Extension Name Set

4.5.8 KX-T7235 Display Features - Call Directory

You can make a call using the call directory by pressing the desired button which is corresponding to the display message. The example operations are shown below.

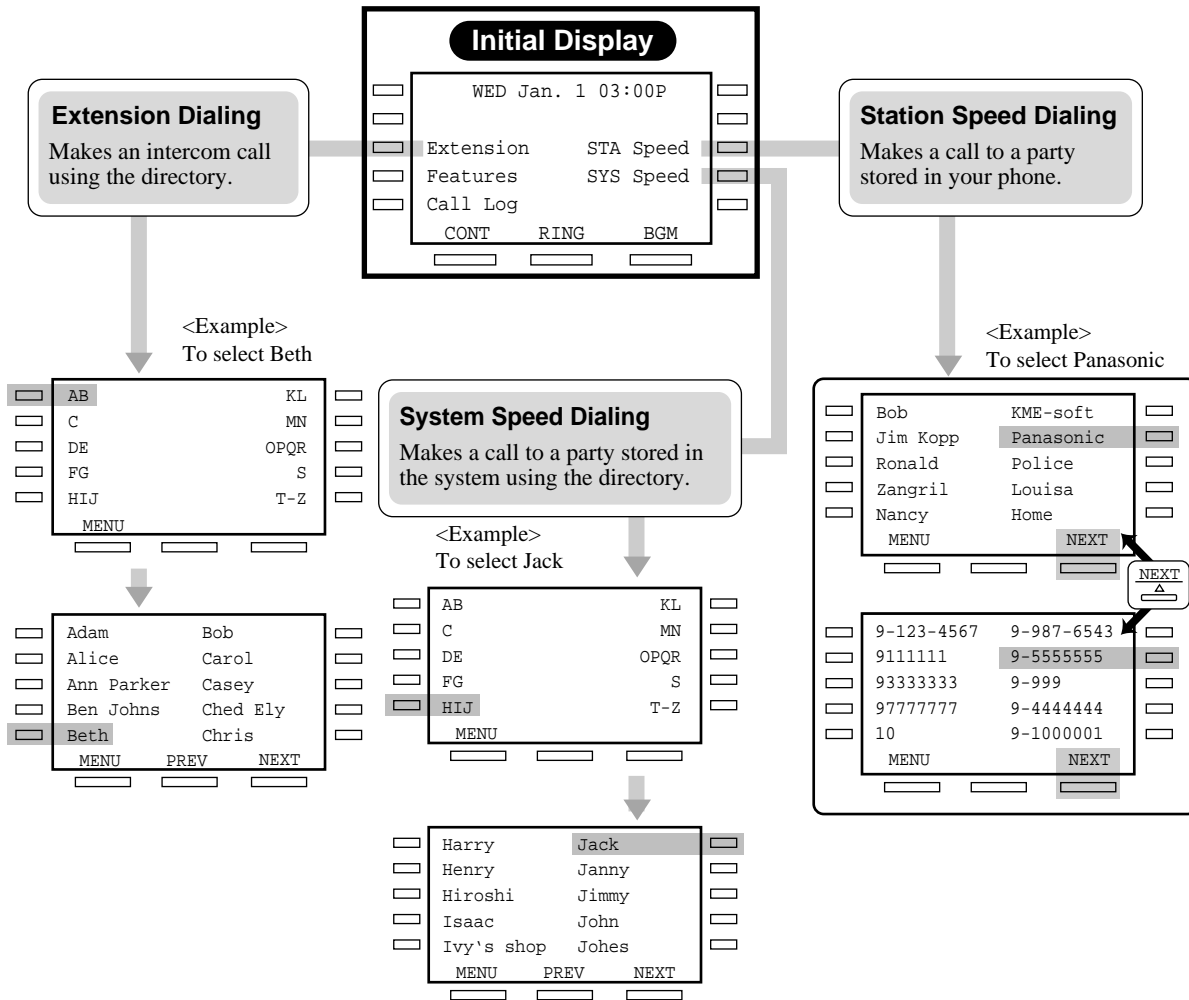

Extension Dialing / System Speed Dialing

1. Press the **Extension** (F3) or **SYS Speed** (F9) button.
2. Press the **Function** button which is next to the desired alphabet.
3. Press the **Function** button which is next to the desired name.

Station Speed Dialing

1. Press the **STA Speed** (F8) button.
2. Press the **Function** button which is next to the desired name or number.
To alternate the display between name and number, press the **NEXT** (S3) button.

4.5.9 KX-T7235 Display Features - System Feature Access Menu

You can access various features using the messages which are displayed in alphabetical order. To access the features, press the Feature (F4) button on the initial display first, and search for the desired feature message by pressing the NEXT (S3) button.

Then press the Function button which is next to the desired feature message.

To access the features while receiving a call (e.g., ringing, being paged), press the INTERCOM button first. Then follow the procedures on the following pages.

The display sequence may be different depending on the system you are connected to.

Features on the First Display

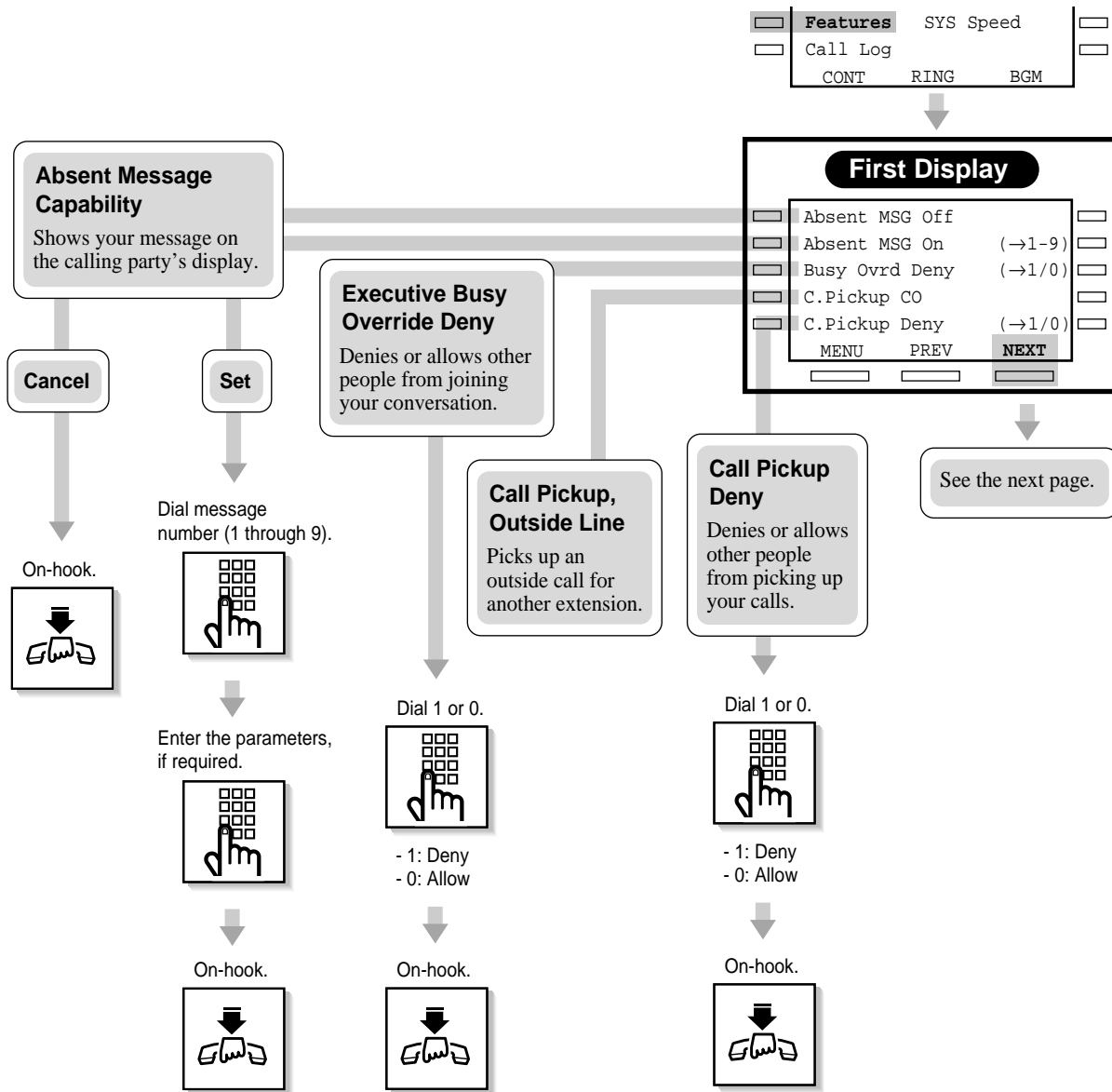

Features on the Second Display

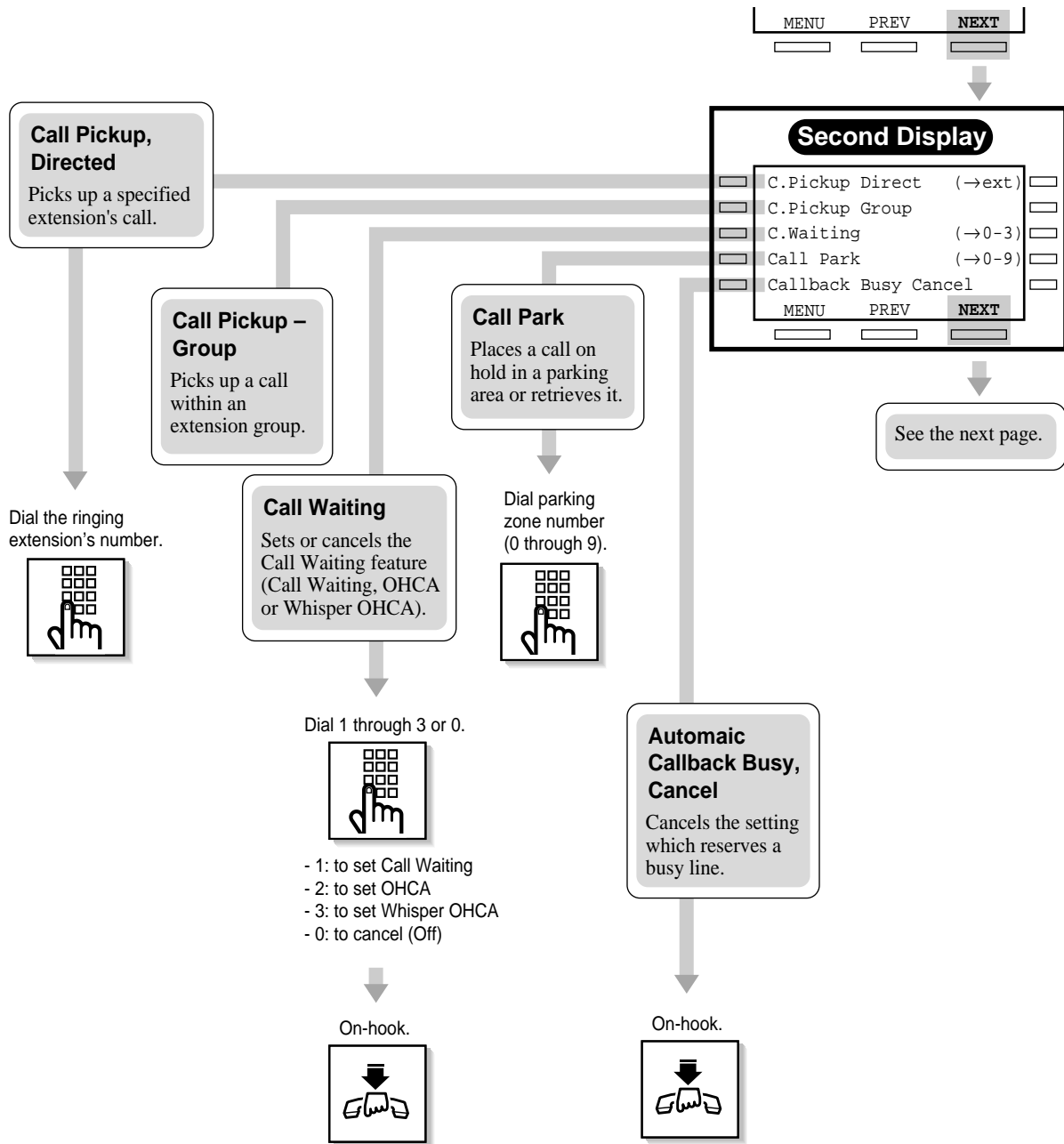

Features on the Third Display

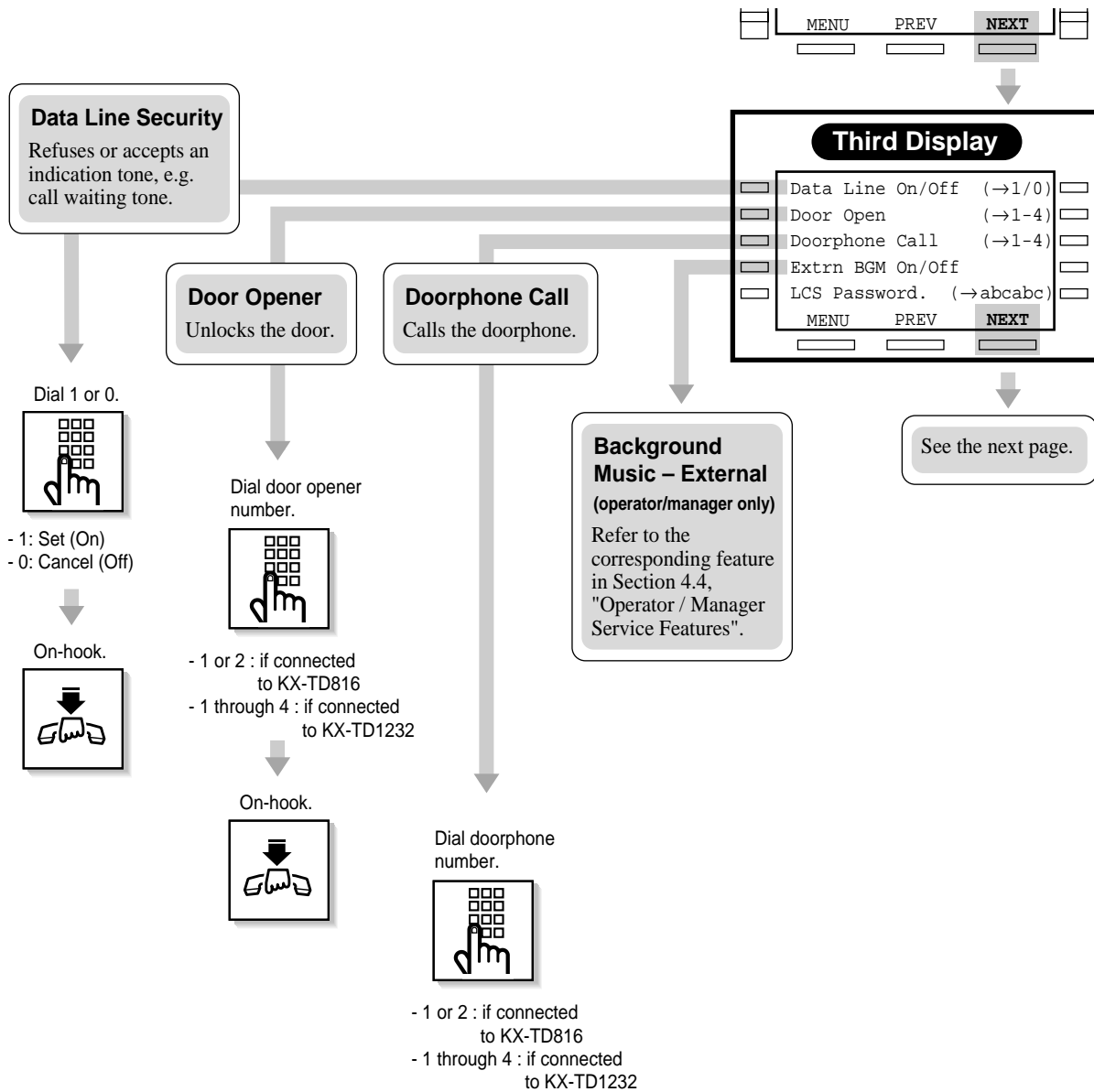

Features on the Fourth Display

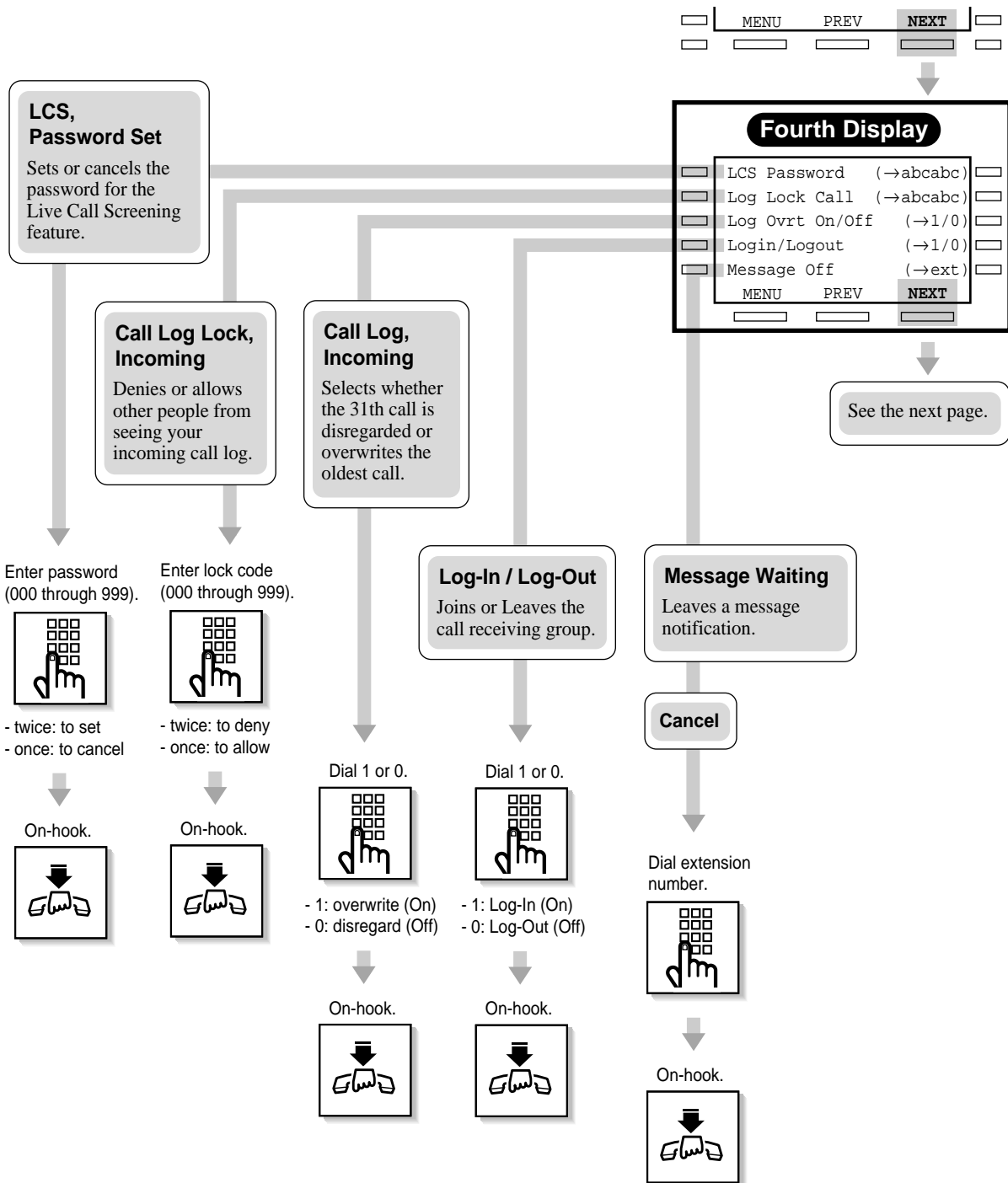

Features on the Fifth Display

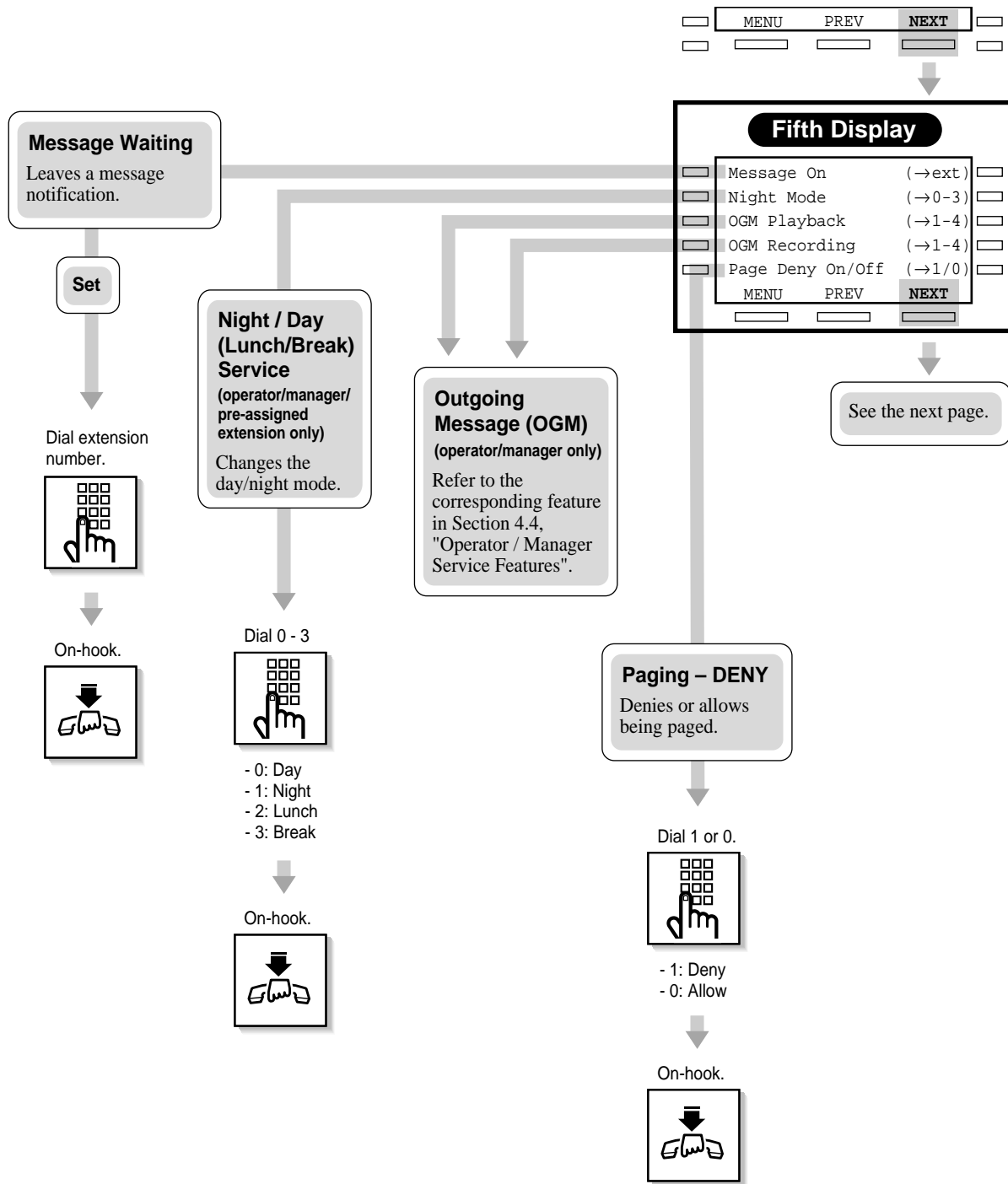

Features on the Sixth Display

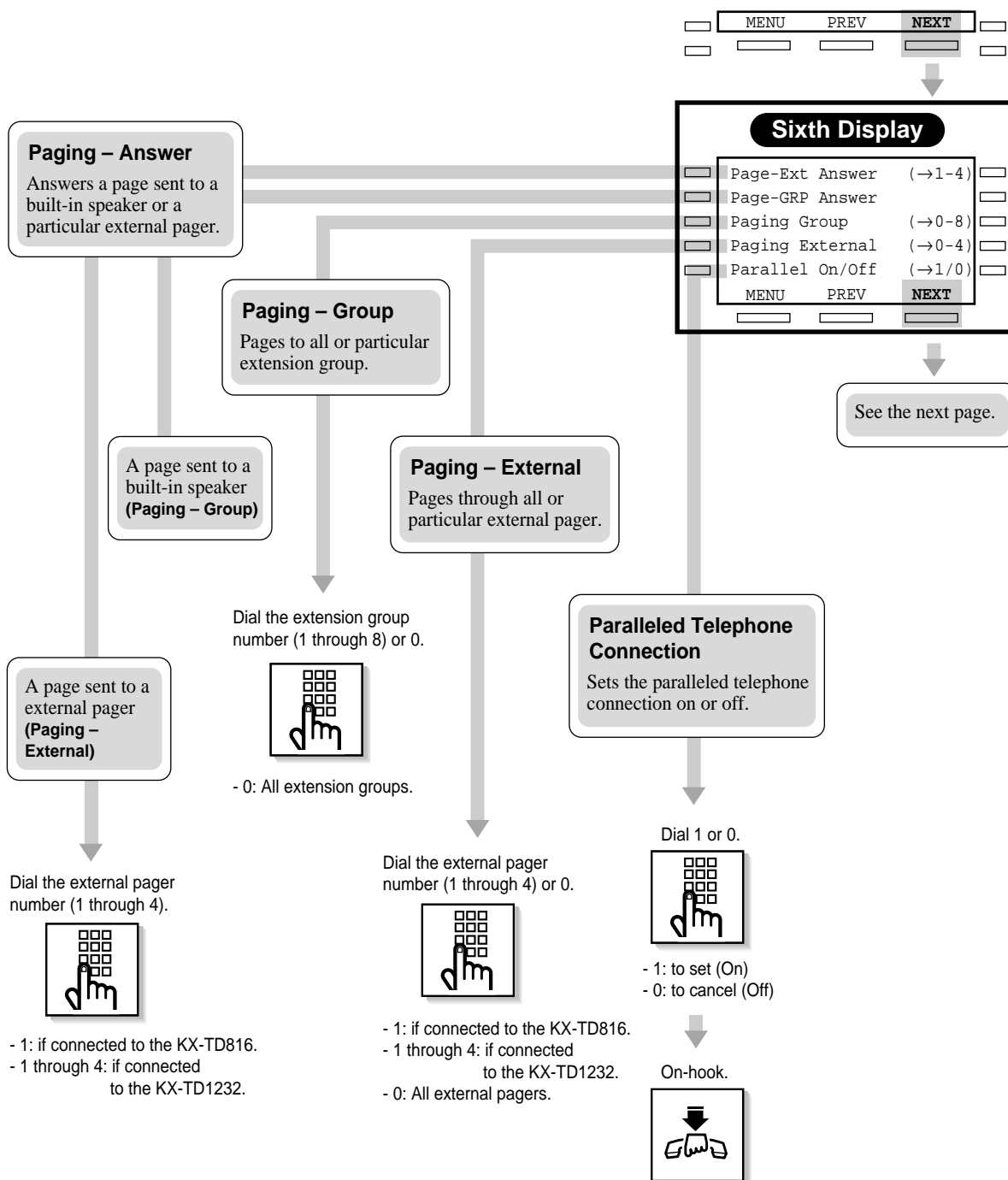

Features on the Seventh Display

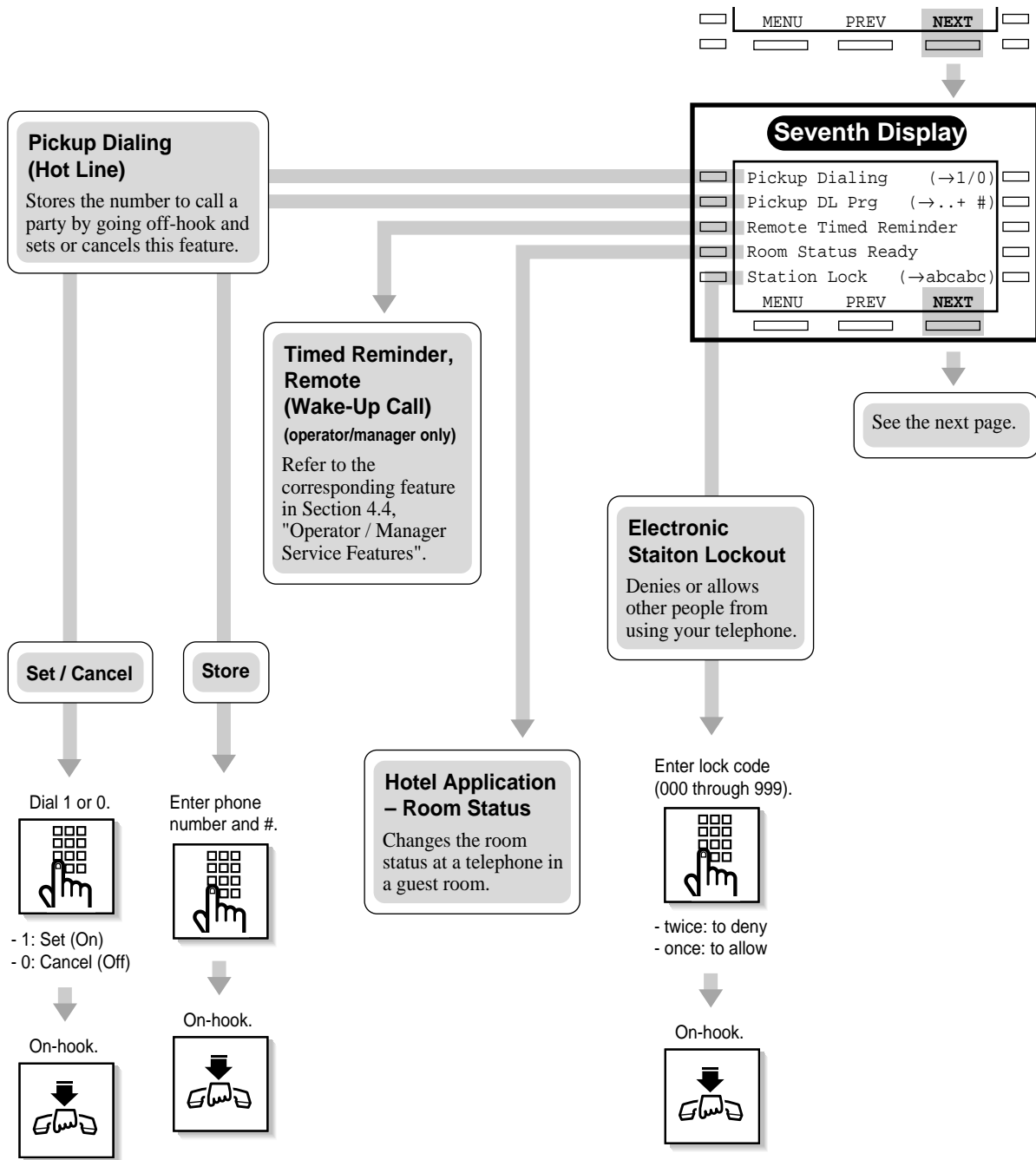

Features on the Eighth Display

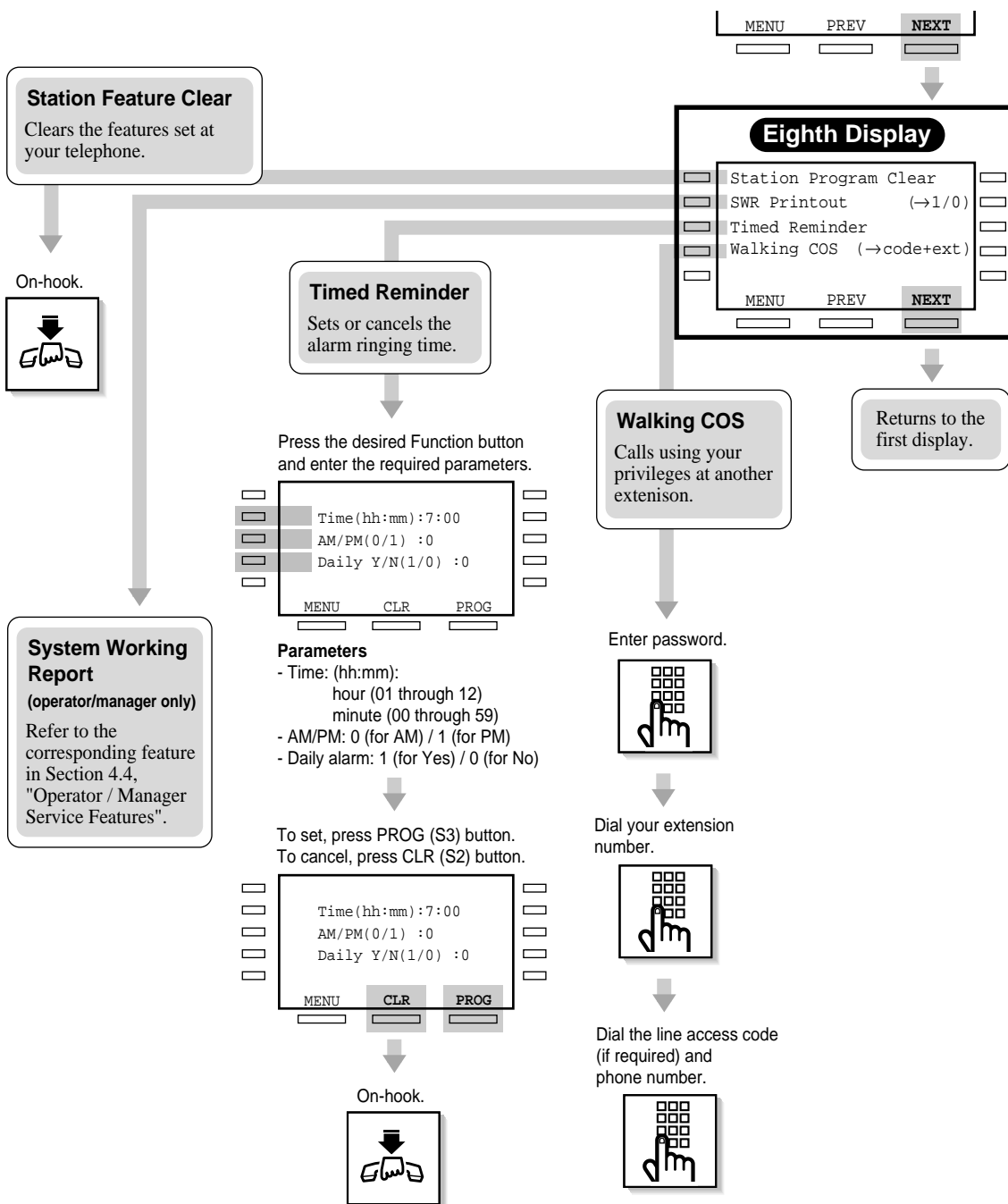

4.5.10 KX-T7431 / KX-T7433 / KX-T7436 Display Features

The KX-T7431, KX-T7433 and KX-T7436 telephones allow you to make a call or operate the features using the display message.

1) Call Directory

- Extension Dialing
- Station Speed Dialing
- System Speed Dialing

2) System Feature Access Menu

The System Feature Access Menu provides a display of the system features which appear in alphabetical order. The available features are as follows:

Absent Message Capability	Hotel Application — Room Status (from a guest room)
Automatic Callback Busy (Camp-On), Cancel	Live Call Screening (LCS), Password Set
Background Music (BGM) — External	Log-In / Log-Out
Call Log, Incoming	Message Waiting
Call Log Lock, Incoming	Night / Day (Lunch / Break) Service
Call Park	Outgoing Message (OGM)
Call Pickup, Directed	Paging — External
Call Pickup, Group	Paging — Group
Call Pickup, Outside Line	Paging — ANSWER
Call Pickup Deny	Paging — DENY
Call Waiting	Paralleled Telephone Connection
Data Line Security	Pickup Dialing (Hot Line)
Door Opener	Station Program Clear
Doorphone Call	System Working Report
Electronic Station Lockout	Timed Reminder
Executive Busy Override Deny	Timed Reminder, Remote (Wake-Up Call)
	Walking COS

3) Hotel Application (KX-T7436 only)

The display message for the Hotel Application appears only when it is enabled in system programming.

Jog Dial Operation

You can search for desired items on the corresponding display menu by using the Jog Dial. Rotate the Jog Dial in either direction as desired. The items will be displayed as follows.

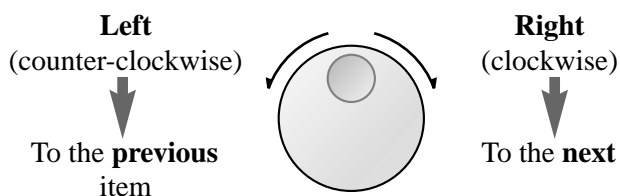

Jog Dial Operation Display

— KX-T7431

While idle, the display changes as follows by pressing the MODE button. The Jog Dial operation is available in the second through seventh displays.

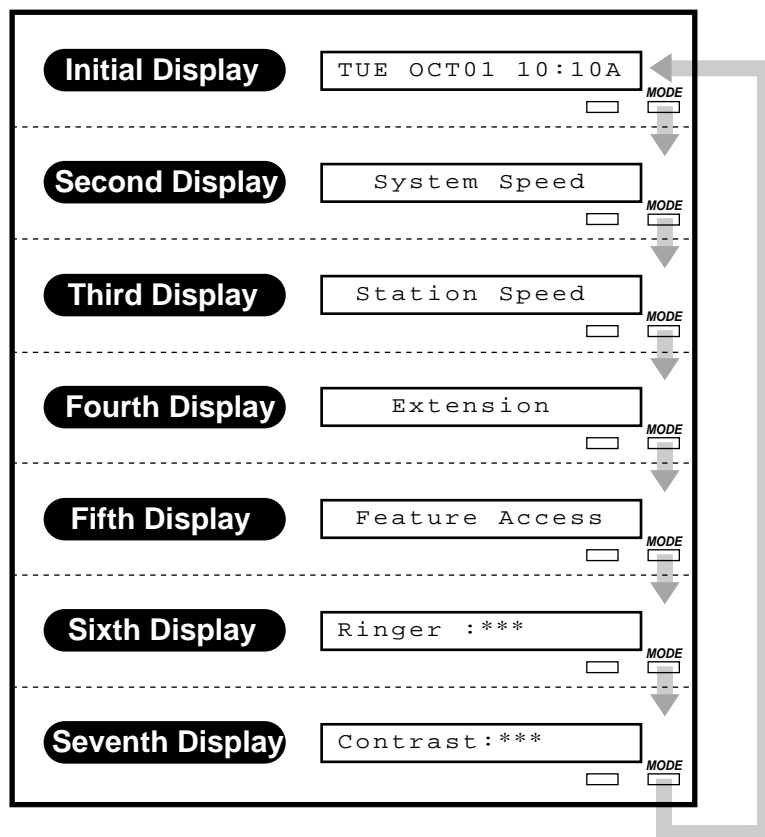

— **KX-T7433**

The Jog Dial operation is available in the third display. While idle, the bottom line of the display changes by pressing the SHIFT button as follows.

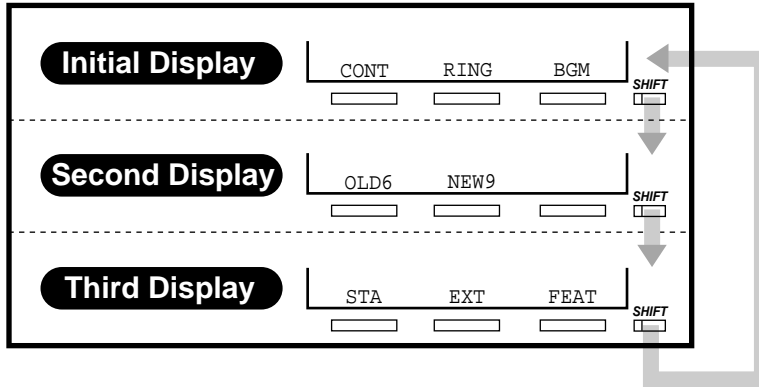

— **KX-T7436**

The Jog Dial operation is available in the initial and third display. While idle, the bottom line of the display changes by pressing the SHIFT button as follows.

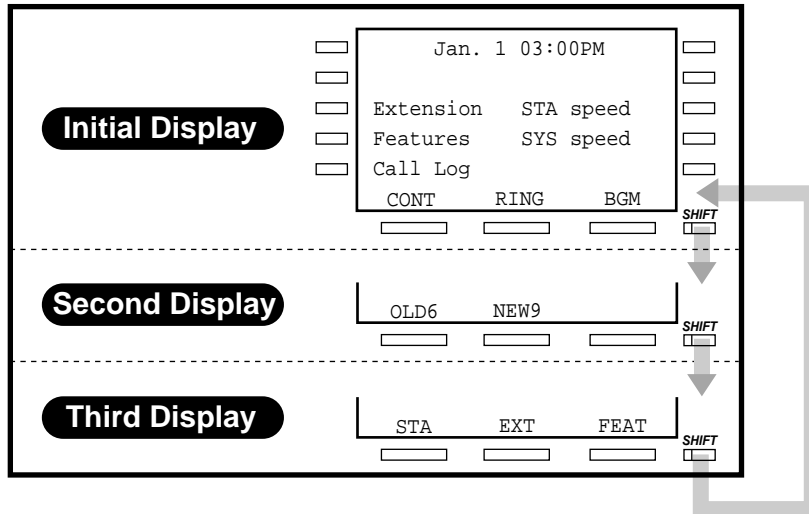

Conditions

- The sixth and seventh displays of the KX-T7431 are used for the ringer volume and display contrast adjustments. For details, refer to the "Initial Setting for KX-T7400 Series" 1.1.1 Configuration in this manual.

4.5.11 KX-T7431 / KX-T7433 / KX-T7436 Display Features - Call Directory

There are three Call Directory features as follows.

Feature	Description	Condition
Extension Dialing	You can make an intercom call using the directory.	Only items which have a name assigned are displayed in alphabetical order.
System Speed Dialing	You can make a call to a party stored in the system using the directory.	
Station Speed Dialing	You can make a call to a party stored in your phone	Items which have a name assigned are displayed by priority in stored order. If a name is not assigned, the number is displayed. The displaying mode, name or number, can be assigned in System Programming.

To use the Call Directory, you may shift the display to the Jog Dial Operation display by pressing the SHIFT or MODE button first. Then follow the procedures on the following pages.

Programming Guide References

- [001] System Speed Dialing Number Set
- [002] System Speed Dialing Name Set
- [003] Extension Number Set
- [004] Extension Name Set
- [012] ISDN Extension Number Set
- [013] ISDN Extension Name Set
- [990] System Additional Information

User Manual References

- 2.2.8 Station Speed Dialing Number/Name Assignment [KX-T7235/KX-T7431/KX-T7433/KX-T7436 only]
- 3.2.2 [001] System Speed Dialing Number Set
- 3.2.3 [002] System Speed Dialing Name Set
- 3.2.4 [003] Extension Number Set
- 3.2.5 [004] Extension Name Set

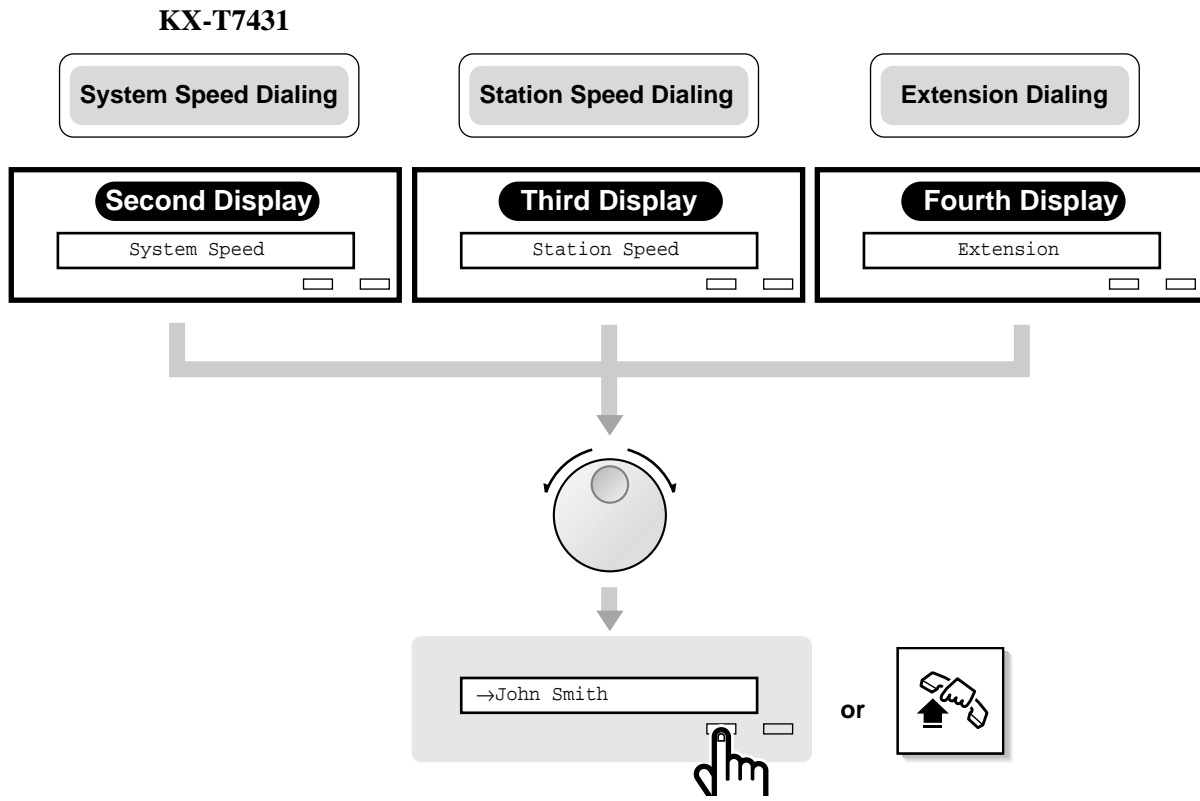

System Speed Dialing / Station Speed Dialing / Extension Dialing

1. Rotate the **Jog Dial** until the desired item is displayed.
2. Press the **SELECT** button or **go off-hook**.

Note

- You can lift the handset or press the SP-PHONE button instead of the SELECT button.
- Press the MODE button to return to the initial display.
- For System Speed Dialing and Extension Dialing, before rotating the Jog Dial, you can press the corresponding alphabet key to select the desired letter.
<Example> Press 2 twice to display "B" items.

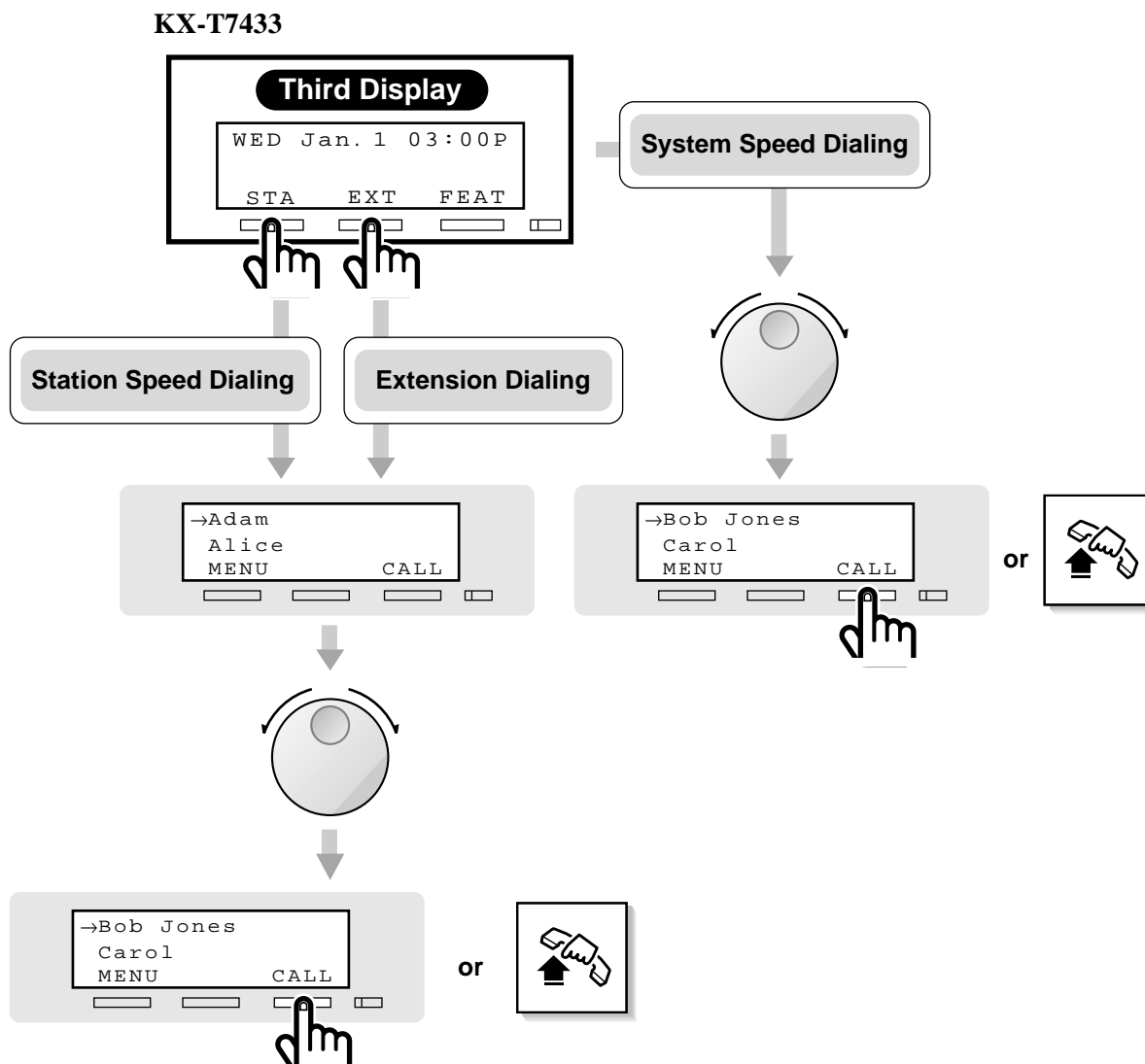

System Speed Dialing

1. Rotate the Jog Dial until the desired item is at the arrow.
2. Press the **CALL** (S3) button or go off-hook.

Note

- For System Speed Dialing and Extension Dialing, before rotating the Jog Dial, you can press the corresponding alphabet key to select the desired letter.
<Example> Press 2 twice to display "B" items.

Station Speed Dialing / Extension Dialing

1. Press the **STA** (S1) or **EXT** (S2) button.
2. Rotate the Jog Dial until the desired item is at the arrow.
3. Press the **CALL** (S3) button or go off-hook.

KX-T7436

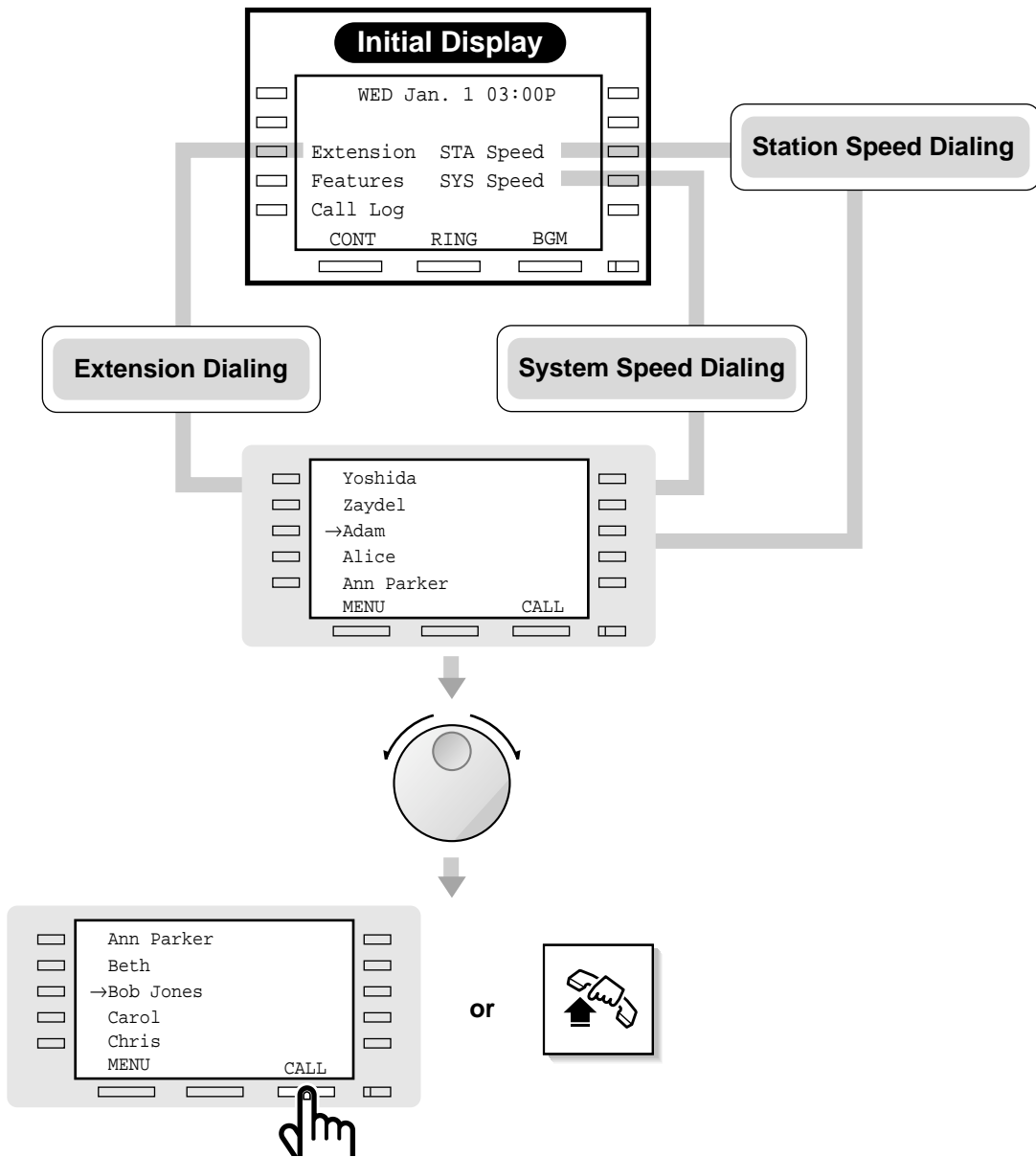

Extension Dialing / Station Speed Dialing / System Speed Dialing / Note

1. Press the **Extension** (F3), **STA Speed** (F8) or **SYS Speed** (F9) button.
2. **Rotate the Jog Dial** until the desired item is at the arrow.
3. Press the **CALL** (S3) button or **go off-hook**.

- You can press the Function button (F1 through F10) on the same line of the desired item instead of the CALL (S3) button.
- For System Speed Dialing and Extension Dialing, before rotating the Jog Dial, you can press the corresponding alphabet key to select the desired letter.
<Example> Press 2 twice to display "B" items.

— Using the Soft button or rotating Jog Dial directly —

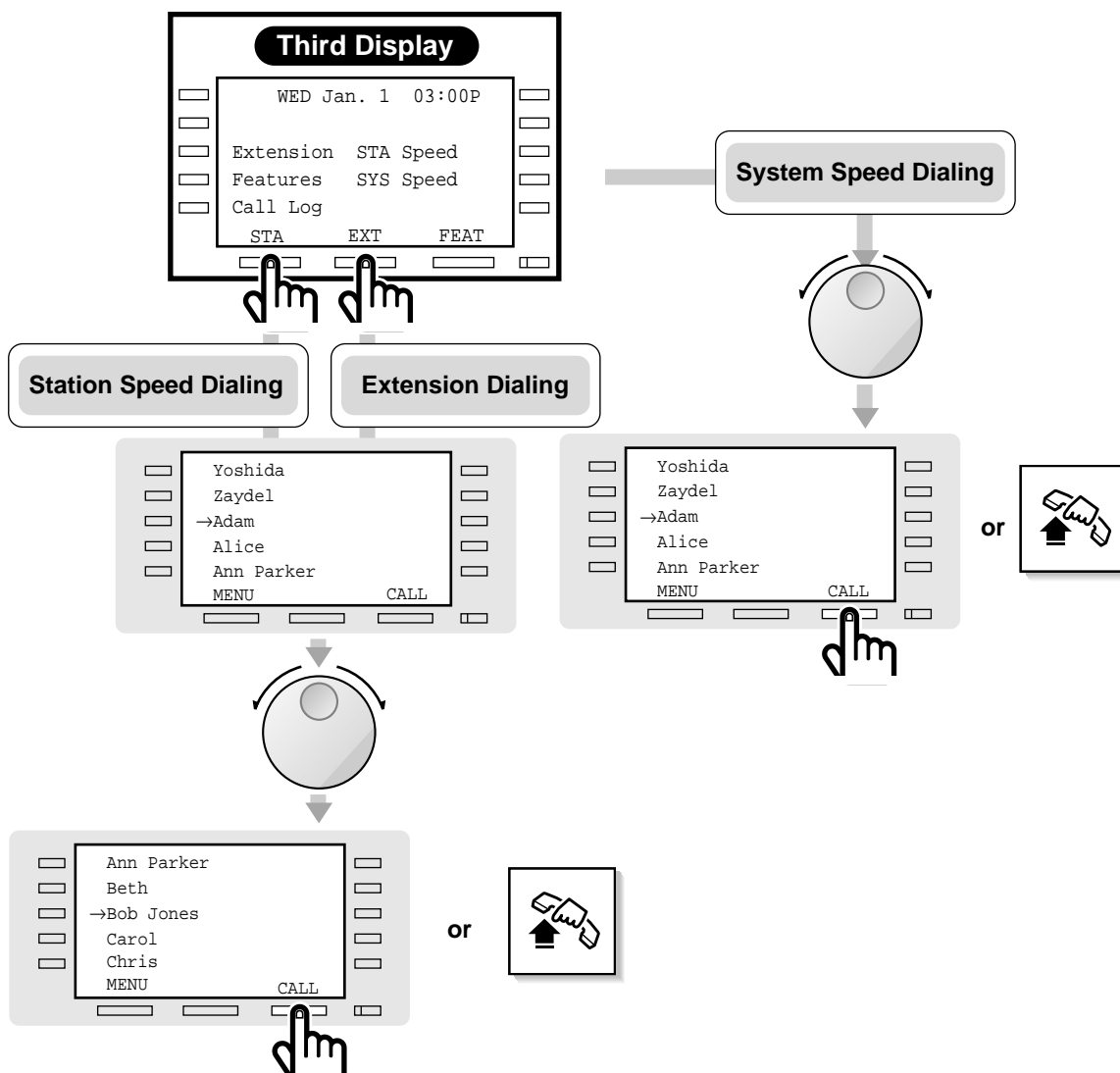
**System Speed Dialing**

1. Rotate the Jog Dial until the desired item is at the arrow.
2. Press the CALL (S3) button or go off-hook.

Station Speed Dialing / Extension Dialing

1. Press the STA (S1) or EXT (S2) button.
2. Rotate the Jog Dial until the desired item is at the arrow.
3. Press the CALL (S3) button or go off-hook.

Note

- You can press the Function button (F1 through F10) on the same line of the desired item instead of the CALL (S3) button.
- For System Speed Dialing and Extension Dialing, before rotating the Jog Dial, you can press the corresponding alphabet key to select the desired letter.
<Example> Press 2 twice to display "B" items.

4.5.12 KX-T7431 / KX-T7433 / KX-T7436 Display Features - System Feature Access Menu

You can access the features which are displayed in alphabetical order.

To access the features, you may shift the display to the Jog Dial Operation display by pressing the MODE or SHIFT button first. Then follow the procedures below.

To access the features while receiving a call (e.g., ringing, being paged), press the INTERCOM button first. Then follow the procedures below.

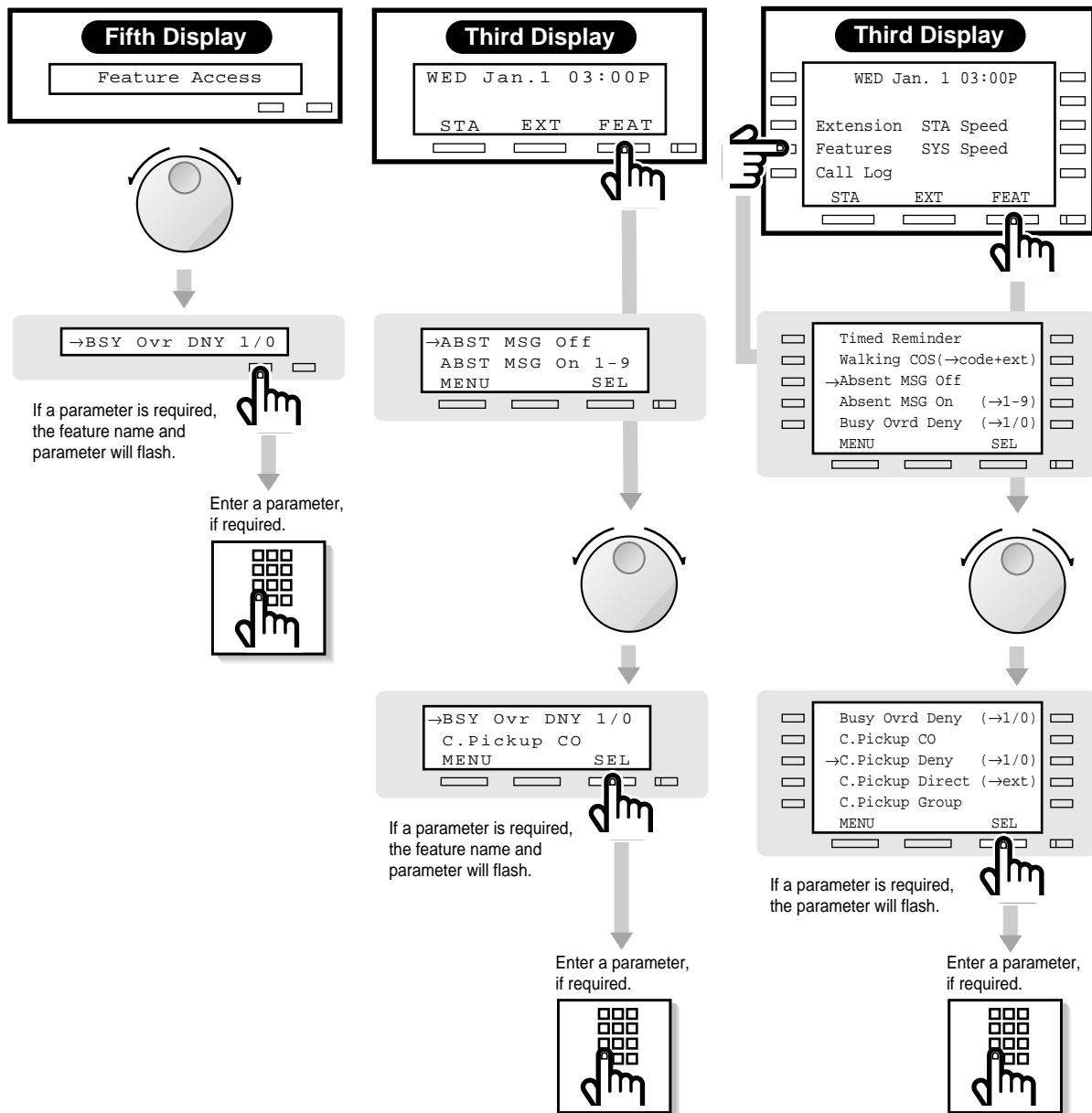

KX-T7431

1. **Rotate the Jog Dial** until the desired item is displayed.
2. Press the **SELECT** Button.
3. Enter the parameter, if required.

KX-T7433

1. Press the **FEAT** (S3) button.
2. **Rotate the Jog Dial** until the desired item is at the arrow.
3. Press the **SEL** (S3) button.
4. Enter the parameter, if required.
5. On-hook, if required.

KX-T7436

1. Press the **Features** (F4) or **FEAT** (S3) button.
2. **Rotate the Jog Dial** until the desired item is at the arrow.
3. Press the **SEL** (S3) button.
4. Enter the parameter, if required.
5. On-hook, if required.

Note

- When using a KX-T7436, you can press the Function button (F1 through F10) on the same line of the desired item instead of the SEL (S3) button.
- When using a KX-T7436, you can press the Feature (F4) button in any display (initial through third).
- Before rotating the Jog Dial, you can press the corresponding alphabet key to select the desired letter.
<Example> Press 2 twice to display "B" items.

System Feature List

You can access the following features which are displayed in alphabetical order. The parameters use in the list are for a telephone connected to a KX-TD1232. For more details about the features and the required parameters, refer to the respective features in 4.3 Station Features and Operation, and 4.4 Operator / Manager Service Features.

Display (KX-T7436/KX-T7235)	Display (KX-T7431/KX-T7433)	Feature Description
Absent MSG Off	ABST MSG Off	Cancel the absent message.
Absent MSG On (→1-9)	ABST MSG On 1-9	Set an absent message.
Busy OvrD Deny (→1/0)	BSY Ovr DNY 1/0	Deny or allow other people from joining your conversation.
C.Pickup CO	C.Pickup CO	Pick up a CO call for another extension.
C.Pickup Deny (→1/0)	C.PickupDNY 1/0	Deny or allow other people from picking up your calls.

Display (KX-T7436/KX-T7235)	Display (KX-T7431/KX-T7433)	Feature Description
C.Pickup Direct (→ext)	C.PickupDRT ext	Pick up a specific extension's call.
C.Pickup Group	C.Pickup GRP	Pick up a call within your extension group.
C.Waiting (→0-3)	C.Waiting 0-3	Cancel or set the Call Waiting feature (Call Waiting, OHCA or Whisper OHCA).
Call Park (→0-9)	Call Park 0-9	Place a call on hold in a system parking area.
Callback Busy Cancel	Callback Cancel	Cancel the setting which reserves a busy line.
Data Line On/Off (→1/0)	Data Line 1/0	Refuse or accept an indication tone, e.g., call waiting tone.
Door Open (→1-4)	Door Open 1-4	Unlock the door.
Doorphone Call(→1-4)	Doorphone 1-4	Call the doorphone.
Extrn BGM On/Off	Ext-BGM On/Off	Turn on/off the background music through the external pagers.* ¹
LCS Password (→abcabc)	LCS # abcabc	Assign the password for the Live Call Screening feature.
Log Lock Call (→abcabc)	Log Lock abcabc	Deny other people from seeing your call log.
Log Overt On/Off(→1/0)	Log Overt 1/0	Select how the 31st call is treated, either it is disregarded or overwrites the oldest call.
Login/Logout (→1/0)	Login/out 1/0	Join or leave an extension group.
Message Off (→ext)	MSG Off ext	Cancel a message waiting notification.
Message On (→ext)	MSG On ext	Leave a message waiting notification so that the called party may call you back.
Night Mode (→0-3)	Night Mode 0-3	Change the day/night mode.* ¹
OGM Playback (→1-4)	OGM Play 1-4	Playback the outgoing message.* ¹
OGM Recording (→1-4)	OGM Record 1-4	Record an outgoing message.* ¹
Page Deny On/Off (→1/0)	Page Deny 1/0	Deny or allow being paged.
Page-Ext Answer(→1-4)	Page-E ANS 1-4	Answer the page through a speaker.
Page-GRP Answer	Page-GRP ANS	Answer the page through a telephone in the same paging group.

Display (KX-T7436/KX-T7235)	Display (KX-T7431/KX-T7433)	Feature Description
Paging External (→0-4)	Page Extrn 0-4	Page through the speaker.
Paging Group (→0-8)	Page GRP 0-8	Page to all or a particular paging group.
Parallel On/Off(→1/0)	Parallel 1/0	Set whether a Single Line Telephone connected in parallel will ring or not when receiving a call.
Pickup Dialing (→1/0)	Pickup Dial 1/0	Set or cancel the feature, calling to a pre-set party by going off-hook.
Pickup DL Prg (→..+#)	Pickup DL PG..#	Store the extension or phone number to call a party by going off-hook.
Remote Timed Reminder	R-Timed Remind	Set the alarm ringing time for any extension.*2
Room Status Ready	Room Ready	Change the room status at a telephone in a guest room
Station Lock (→abcabc)	St. Lock abcabc	Prevent other people from making an outgoing CO call from your extension.
Station Program Clear	STA. Prog Clear	Clear the features set at your telephone.
SWR Printout (→1/0)	SWR Print 1/0	Print out or clear the system working report.*1
Timed Reminder	Timed Reminder	Set the alarm ringing time.*3
Walking COS (→code+ext)	WK.COS code+ext	Call using your privileges at another extension.

*1 Only available for the Manager and the Operators.

*2 Only available for the operators and manager. After selecting this message, follow the steps in the "Timed Reminder, Remote" feature in Section 4.4 Operator / Manager Service Features.

*3 After selecting this message, follow the steps as follows.
 – KX-T7436: steps of the "Timed Reminder" feature in "KX-T7235 Display Features – System Feature Access Menu (Features on the Eighth Display)" in this section.
 – KX-T7431 and KX-T7433: steps after dialing the feature number (76) of the 4.3.78 Timed Reminder feature.

Section 5

DSS Console Features

Note: All illustrations of the DPT (paired telephone) used in these operating instructions are based on model KX-T7235.

5.1 Configuration

5.1.1 Configuration

With a Directed Station Selection (DSS) Console, you can make or transfer calls and access system features with the touch of a button. The DSS Console must be connected to the Panasonic Digital Super Hybrid System and paired with a DPT. System Programming is required to designate the jack number of the paired PT. With a paired telephone, you can carry out the following operations using the DSS Console:

- Direct access to an extension (Direct Station Dialing)
- Quick access to an outside party (One-Touch Dialing)
- Quick access to a system feature (One-Touch Access for System Features)
- Easy transfer to an extension (Call Transfer)

The above functions are enabled simply by pressing buttons on the console which are pre-programmed as function buttons through Station Programming.

Panasonic KX-T series DSS Consoles are categorized as follows:

KX-T7240	DSS Console (32-DSS buttons, 16-PF buttons)
KX-T7440	DSS Console (66-DSS buttons)
KX-T7441	DSS Console for Attendant (48-DSS buttons, ANSWER button, RELEASE button)

Conditions

- The DSS Console and the PT should be placed side by side on your desk.
- A single line telephone cannot be utilized in conjunction with the DSS Console.
- For System Programming, please consult with your dealer.

Programming Guide References

[007] DSS Console Port and Paired Telephone Assignment

5.1.2 Location of Controls

KX-T7240

DSS Buttons with Busy Lamp Field (BLF) (01 through 32):

Used to access extensions. The BLF indicates the busy or idle status of each corresponding extension in the system. These buttons can also be changed to other function buttons.

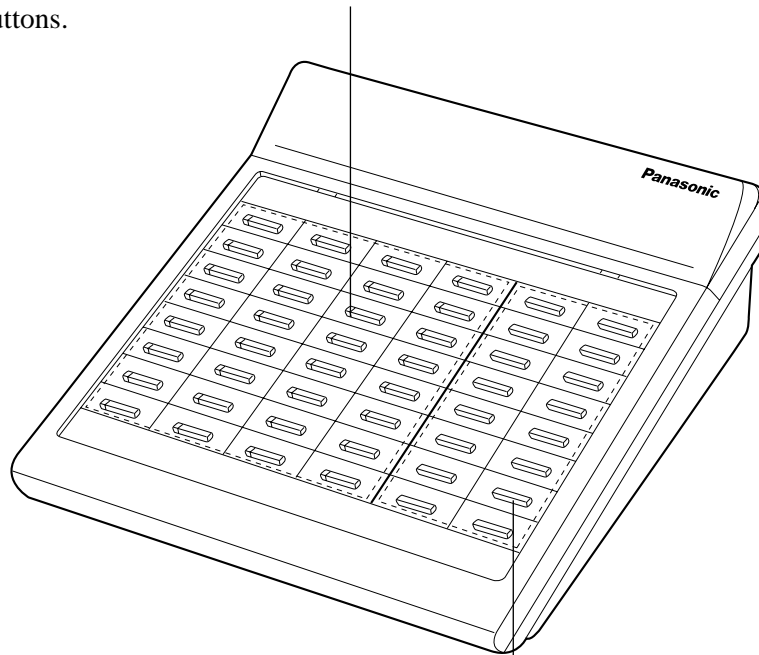

PF (Programmable Feature) Buttons (01 through 16):

These buttons are provided with no default settings. With a paired telephone, you can program the buttons as other function buttons.

<Back View>

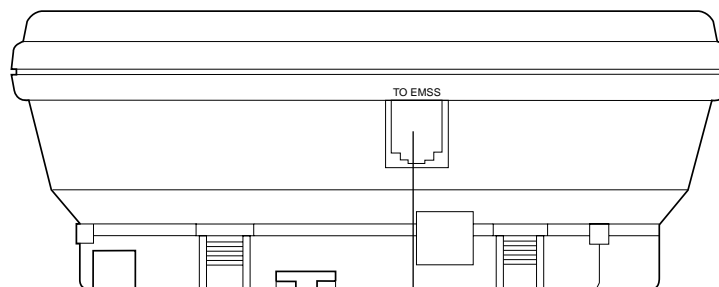

Used to connect to the Panasonic Digital Super Hybrid System

KX-T7440

**DSS Buttons with
Busy Lamp Field (BLF)(01 through 66)**

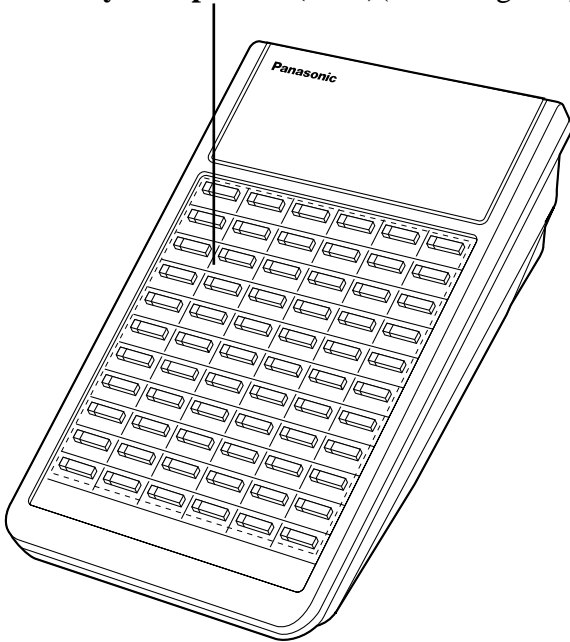

KX-T7441

**DSS Buttons with
Busy Lamp Field (BLF)(01 through 48)**

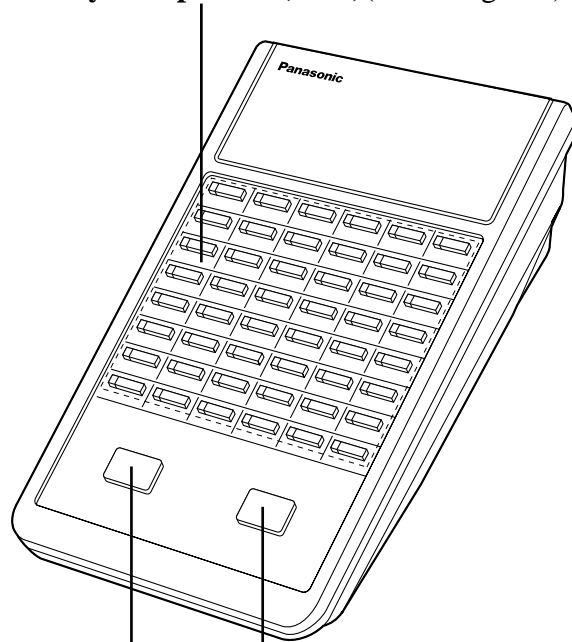

ANSWER Button RELEASE Button

Connection

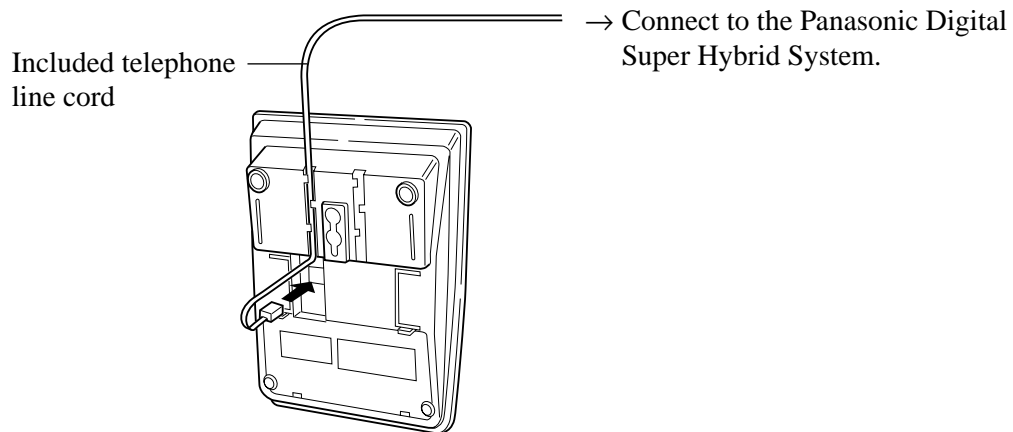

5.1.3 Feature Buttons

DSS Consoles have the following types of Feature Buttons:

DSS Buttons with Busy Lamp Field (BLF)

Used to access extensions. The BLF indicates the busy or idle status of each extension in the system. These buttons can also be changed to other function buttons.

PF (Programmable Feature) Buttons [KX-T7240 only]

These buttons are provided with no default settings. With a paired telephone, you can program the buttons as other function buttons.

ANSWER Button [KX-T7441 only]

Used to answer an incoming call.

RELEASE Button [KX-T7441 only]

Used to disconnect the line.

5.2 Station Programming

5.2.1 Station Programming Instructions

PF buttons are provided with no default settings, while each DSS button has a default setting as follows. DSS 01-32: extension numbers 101-132 (DSS 33-66: not stored).

To meet your various needs, DSS buttons can be changed to other function buttons.

Every DSS or PF button can be assigned to another extension number, telephone number or feature number through Station Programming.

Conditions

- DSS buttons and PF buttons can be changed to any of the following feature buttons through Station Programming:

Button	DSS	PF
Features to be assigned		
Another DSS (Direct Station Selection)	✓	
Phantom Extension	✓	
ONE-TOUCH (One-Touch Dialing)	✓	✓
MESSAGE (Message Waiting)	✓	
MESSAGE (Another/Phantom Extension)	✓	
FWD/DND (Call Forwarding/Do Not Disturb)	✓	✓
SAVE (Saved Number Redial)	✓	✓
ACCOUNT (Account Code Entry)	✓	✓
CONF (Conference)	✓	✓
Voice Mail (VM) Transfer	✓	✓
Two-Way Record*	✓	
Two-Way Transfer*	✓	
LCS (Live Call Screening)*	✓	
LCS (Live Call Screening) Cancel*	✓	
Night/Day (Lunch/Break) Service	✓	

- * Available when the Digital Super Hybrid System is connected to a Digital Proprietary Telephone capable Panasonic Voice Processing System (one that supports digital proprietary telephone integration; e.g., KX-TVS100).

" ✓ " indicates that the feature is available.

- When the STORE button is pressed after programming, you will hear beep tones as follows.
 - One beep: The entry is changed from one that was stored previously.
 - Two beeps: The entry is the same as on stored previously.

Programming Guide References

[007] DSS Console Port and Paired Telephone Assignment

User Manual References

2.2.2 Flexible Button Assignment

5.2.2 Extension Number Assignment

You can assign the desired extension number to a DSS button.

– Be sure that you are in the Station Programming mode: Press [PROGRAM] [9] [9].

PT and DSS Console

<p>[DSS Console]</p> <div style="border: 1px solid black; width: 40px; height: 20px; margin: 0 auto; display: flex; align-items: center; justify-content: center;"> (DSS) </div> <p>Press the desired DSS button.</p>	<p>[Paired telephone]</p> <div style="border: 1px solid black; width: 40px; height: 20px; margin: 0 auto; display: flex; align-items: center; justify-content: center;"> 1 </div> <p>Dial 1.</p>	<p>[Paired telephone]</p> <div style="border: 1px solid black; width: 80px; height: 20px; margin: 0 auto; display: flex; align-items: center; justify-content: center;"> extension no. </div> <p>Enter the desired extension number.</p>	<p>[Paired telephone]</p> <div style="border: 1px solid black; width: 60px; height: 20px; margin: 0 auto; display: flex; align-items: center; justify-content: center;"> AUTO DIAL STORE </div> <p>Press STORE.</p>
---	---	---	---

<PT Display Example>

EXT-
CLR

<PT Display Example>

EXT-xxxx
(-xxxx:extension number)

CLR

- To erase an incorrect entry, press the **CLR (S2)** button or the **TRANSFER (CLEAR)** button. (The TRANSFER button becomes the CLEAR button in the Station Programming mode.)

- The STORE indicator lights.
- The display shows the initial programming mode.

– To exit the Station Programming mode: Press [PROGRAM] or lift the handset.

5.2.3 One-Touch Dialing Assignment

You can assign a DSS or PF button as a One-Touch Dialing button. The number can be an extension number or a telephone number. Up to 16 digits can be stored into each memory location.

—Be sure that you are in the Station Programming mode: Press [PROGRAM] [9] [9].

PT and DSS Console

[DSS Console]	[Paired telephone]	[Paired telephone]	[Paired telephone]
<input type="checkbox"/> (DSS) or <input type="checkbox"/> (PF)	<div style="border: 1px solid black; padding: 5px; display: inline-block;">2</div>	<div style="border: 1px solid black; padding: 5px; display: inline-block;">desired no.</div>	<div style="border: 1px solid black; padding: 5px; display: inline-block;"> AUTO DIAL <input type="checkbox"/> STORE </div>
Press the desired DSS or PF button.	Dial 2 .	Enter the desired number (extension number, phone number, etc.).	Press STORE .

<PT Display Example>

CLR

- The STORE indicator lights.
- The display shows the initial programming mode.

- Up to 16 digits can be stored.
- When you assign an outside phone number, you must enter a line access code first.
- To erase an incorrect entry, press the **CLR (S2)** button or the **TRANSFER (CLEAR)** button.
(The TRANSFER button becomes the CLEAR button in the Station Programming mode.)

—To exit the Station Programming mode: Press [PROGRAM] or lift the handset.

5.2.4 One-Touch Access Assignment for System Features

You can assign the desired feature number to a DSS or PF button.

—Be sure that you are in the Station Programming mode: Press [PROGRAM] [9] [9].

PT and DSS Console

<p>[DSS Console]</p> <p>(DSS) <input type="text"/> or (PF) <input type="text"/></p> <p>Press the desired DSS or PF button.</p>	<p>[Paired telephone]</p> <p>2</p> <p>Dial 2.</p>	<p>[Paired telephone]</p> <p>feature no.</p> <p>Enter the desired feature number.</p>	<p>[Paired telephone]</p> <p>AUTO DIAL <input type="checkbox"/></p> <p>STORE</p> <p>Press STORE.</p>
--	---	--	---

<PT Display Example>

CLR

- Up to 16 digits can be stored.
- For example, if you wish to gain access to the "Paging-All" feature, enter the feature number 330.
- To erase an incorrect entry, press the **CLR (S2)** button or the **TRANSFER (CLEAR)** button.
(The TRANSFER button becomes the CLEAR button in the Station Programming mode.)

- The STORE indicator lights.
- The display shows the initial programming mode.

—To exit the Station Programming mode: Press [PROGRAM] or lift the handset.

5.3 DSS Console Features

5.3.1 Direct Station Dialing

An extension can be called and accessed, simply by pressing a DSS button. The BLF shows if the extension is busy.

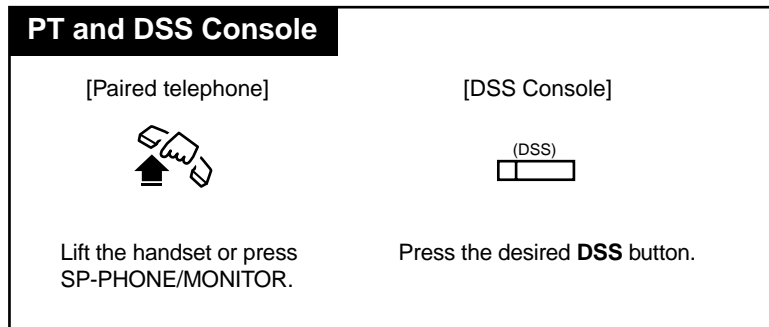

5.3.2 One-Touch Dialing

The stored number is dialed automatically by pressing a programmed DSS or PF button.

PT and DSS Console	
[Paired telephone]	[DSS Console]
	(DSS) <input type="text"/> or (PF) <input type="text"/>
Lift the handset or press SP-PHONE/MONITOR.	Press the desired DSS or PF button.

5.3.3 One-Touch Access for System Features

You can access system features by pressing a programmed DSS or PF button.

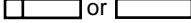

PT and DSS Console	
[Paired telephone]	[DSS Console]
	(DSS) or (PF) 
Lift the handset or press SP-PHONE/MONITOR.	Press the desired DSS or PF button.

5.3.4 Call Transfer

A call can be transferred to an extension by using the DSS button.

PT and DSS Console

During a conversation;

[Paired telephone]	[DSS Console]
TRANSFER 	(DSS) 
Press TRANSFER .	Press the desired DSS button.

One-Touch Transfer

An outside call can be transferred to an extension with an One-Touch operation.

The One-Touch Transfer function must be set through System Programming.

PT and DSS Console

During a conversation;

[DSS Console]

(DSS)

Press the desired **DSS** button.

- The other party is placed on hold and the destination extension is called immediately.

Programming Guide References

[108] Automatic Hold by CO / DSS Button

5.3.5 ANSWER and RELEASE Buttons Operation [KX-T7441 only]

The DSS Console for Attendant KX-T7441 is provided with the ANSWER button and the RELEASE button which are useful for operators who use headsets.

For other DSS Consoles, ANSWER button and RELEASE button can be assigned to a DSS or PF button.

With the ANSWER button, you can answer all incoming calls to the paired telephone.

With the RELEASE button, you can disconnect the line during or after a conversation or complete a Call Transfer.

Answering a call

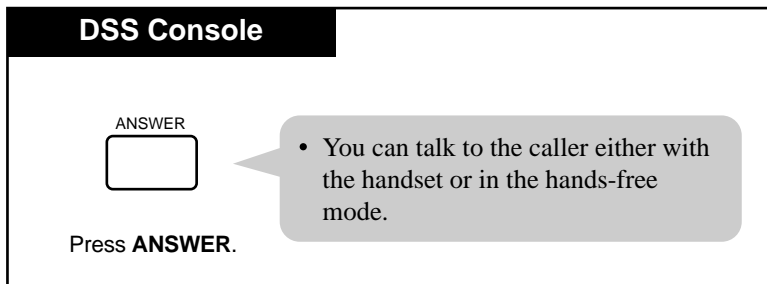

Call Transfer

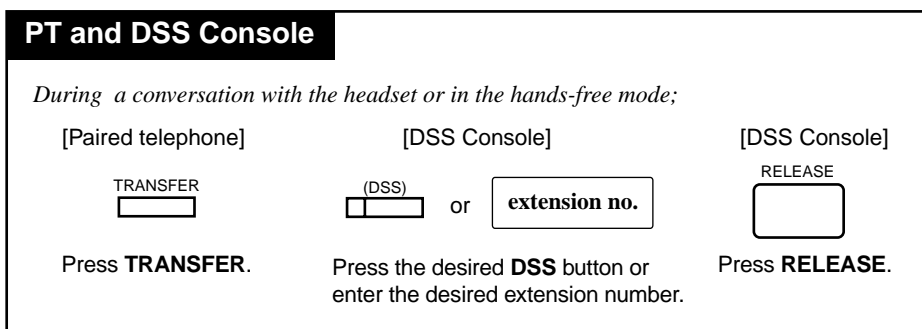

One-Touch Transfer

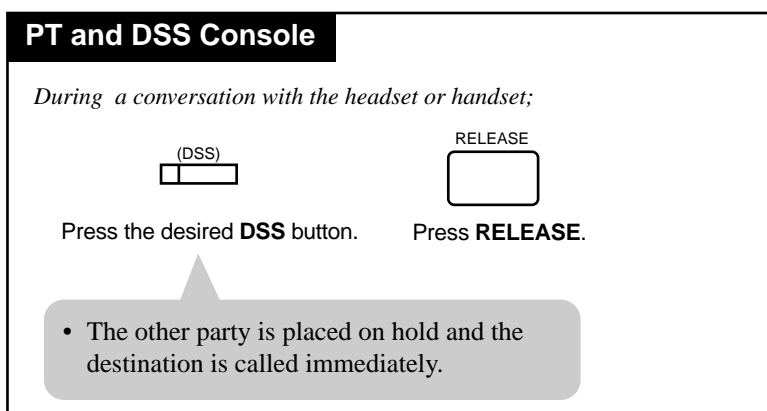

Programming Guide References

[108] Automatic Hold by CO / DSS Button

Section 6
APPENDIX

6.1 APPENDIX

6.1.1 Display Examples

Due to the Bilingual Display Selection Feature, you can select the display in English or French. The left part is the English display and the right part is the French display.

English Display	French Display	Description
Set Time & Date	REGLER HEUR/DATE	Factory setting. — Shown on the manager's display only.
FRI JAN01 12:00A	VEN JAN01 12:00A	The current date and time are not set. — Pressing "*" while on-hook alternates between this display and the self extension number and name display.
123:	123:	Make or receive an intercom call, name is not assigned.
123:Tony Viola	123:TONY VIOLA	Make or receive an intercom call; name is assigned. Confirm key programming on the DSS or MESSAGE button.
234: Busy	234: OCCUPE	Destination extension is busy.
456: DND	456: NPD	Destination extension is set to "Do Not Disturb (DND)".
567: Free	567: LIBRE	Called by "Camp-On" (intercom recall).
345:MDM Access	345: ACCES MDM	Destination is modem for remote access.
1234567890	1234567890	Called by an outside line with the Caller ID*1-number.
Panasonic	PANASONIC	Called by an outside line, with the Caller ID*1-number.
950-1001PP12345&	950-1001PP12345&	Confirm key programming on the REDIAL, SAVE, or One-Touch Dialing button.
→123:Tony Viola	→123:TONY VIOLA	Make or receive an intercom call after the call is transferred; name is assigned.
→CO 02	→LR 02	Called by an outside line after a call is transferred.
→234: Busy	→234: OCCUPE	Destination extension is busy after the call is transferred.
456: DND	456: NPD	Destination extension is set to "Do Not Disturb (DND)" after the call is transferred.

English Display	French Display	Description
Account	COMPTE	Confirm key programming on the Account button.
Alarm 10:15AM	AVERT. 10:15AM	Complete to set or called by "Timed Reminder" (one-time mode). Confirm "Timed Reminder" programming.
Alarm 10:15AM*	AVERT. 10:15AM*	Complete to set or called by "Timed Reminder" (everyday mode). Confirm "Timed Reminder" programming.
Alarm Cancelled	AVERT. ANNULE	Cancel "Timed Reminder".
Alarm Not Stored	AVERT. NON REGLE	Confirm "Timed Reminder" programming when it is not stored.
All Call Page	RECH INT ET EXT	Access to "Paging — All".
At Ext 123	At Ext 123	Absent Message 3.
Back at 11:00	Back at 11:00	Absent Message 4.
BGM On	MUSIQUE:OUI	Start BGM.
BGM Off	MUSIQUE:NON	Stop BGM.
Break Mode	MODE DEJEUNER	Complete to set "Break Mode".
Busy	OCCUPE	Resource is busy.
Busy Ovrde Allow	ENT. TIERS:OUI	Cancel "Executive Busy Override Deny".
Busy Ovrde Deny	ENT. TIERS:NON	Complete to set "Executive Busy Override Deny".
C.Pickup Allow	PRSE APPL:OUI	Cancel "Call Pickup Deny".
C.Pickup Deny	PRSE APPL:NON	Complete to set "Call Pickup Deny".
C.Parked at 1	MISE EN ATT A 1	Complete to set "Call Park".
Callback Ext1234	RAPPEL PSTE 1234	Complete to set "Camp-On".
Callback CO01	RAPPEL LR01	Complete to set "Camp-On".
Callback TRG 1	RAPPEL GR LR 1	Complete to set "Camp-On".
Callback CO *	RAPPEL LR *	Complete to set "Camp-On" when there is no idle outside line.
Call Waiting Off	APPEL EN ATT:NON	Cancel "Call Waiting".
Call Waiting 1	AVERT.-ATT:1	Complete to set "Call Waiting 1".
Call Waiting 2	AVERT.-ATT:2	Complete to set "Call Waiting 2".
Call Waiting 3	AVERT.-ATT:3	Complete to set "Call Waiting 3".

English Display	French Display	Description
CO 01	CO 01	Idle outside line is captured. Called by an outside line.
CO 01 0:01'15	LR 01 0:01'15	Duration time of incoming outside call.
CO 01 & CO 02	LR 01 & LR 02	Conference with two outside lines. Called by hold recall. — "Conference, Unattended"
CO 03: Free	LR 3: LIBRE	Called by "Camp-On" (Outside line recall).
CO 02:AB COMPANY	LR 02:AB COMPANY	Received an outside call with a Caller ID; the outside line number and the outside line name are assigned.
Conference	CONFERENCE	Confirm key programming on the Conference button.
CO in Use	LR OCCUPEE	The selected outside line is busy.
CO Not Assigned	LR NON ASSIGNEE	The desired outside line is restricted (not assigned).
CONT RNGOFF BGM	CONT SONN-N MUS	Ringer Volume is off.
Contrast:***	CONTRAST:***	Display Contrast — Adjustment.
Data Mode Off	PROTECTION:NON	Cancel "Data Line Security".
Data Mode On	PROTECTION:OUI	Complete to set "Data Line Security".
Day Mode	SERVICE DE JOUR	Day mode status. (Cancel Night mode.) — "Night / Day (Lunch / Break) Service"
Do Not Disturb	NE PAS DERANGER	Confirm key programming on the FWD/DND button. Complete to set "Do Not Disturb (DND)".
Door 1 Open	PORTE 1 OUVRIR	Complete to open the door.
Doorphone 1	PORTIER TEL. 1	Make or receive a doorphone call.
E123 & CO 01	P123 & LR 01	Conference with an extension and CO line.
E123 & E234	P123 & P234	Conference with two extensions.
Enter ACCNT Code	ENTRER NO COMPTE	Pressing Account Button. — "Account Code Entry"
Enter ID Code	ENTRER CODE ID	Enter the feature number of "CTI Code Entry".
Ext Data Clear	DONN. PST ANNUL.	Execute "Station Program Clear".
External BGM Off	MUS. EXT.:NON	Stop BGM through external pager. — "Background Music (BGM) — External"

English Display	French Display	Description
External BGM On	MUS. EXT. : OUI	Start BGM through external pager. — "Background Music (BGM) — External"
Extrnl Page All	RECH EXT. - TOUS	Access to "Paging — External" (- to all external pagers).
Extrnl Page 1	RECH. EXT. 1	Access to "Paging — External" (- to a specific external pagers).
FWD(ALL) Ext123	RNV(TOUS)PST123	Complete to set "Call Forwarding — All Calls". Confirm key programming on the FWD/DND button.
FWD(B/NA)Ext100	RNV(O/SR)PST100	Complete to set "Call Forwarding — Busy/No Answer". Confirm key programming on the FWD/DND button.
FWD(BSY) Ext234	RNV(OCC) PST234	Complete to set "Call Forwarding — Busy". Confirm key programming on the FWD/DND button.
FWD(CO) 91201431	RNV(LR) 91201431	Complete to set "Call Forwarding — to Outside Line". Confirm key programming on the FWD/DND button.
FWD(From)Ext123	RNV(DE) PST123	Complete to set "Call Forwarding — Follow Me".
FWD(NA)Ext345	RNV(SR)PST345	Complete to set "Call Forwarding — No Answer". Confirm key programming on the FWD/DND button.
FWD Cancel E123	ANNUL. RNV / P123	Cancel "Call Forwarding — Follow Me (All Calls)" at another extension.
FWD/DND Cancel	ANNULER RNV/NPD	Cancel "Call Forwarding" or "Do Not Disturb (DND)".
Gone Home	Gone Home	Absent Message 2.
Group Page 01	RECHERCHE GR 01	Access to "Paging — Group" (- to a particular paging group).
Group Page All	RECH. GR - TOUS	Access to "Paging — Group" (- to all paging groups).
Handset: **	COMBINE : **	Volume Control — handset on handset mode.
Headset: **	CASQUE: **	Volume Control — headset on headset mode.

English Display	French Display	Description
In a Meeting	In a Meeting	Absent Message 6.
Log Locked :123	REG FERME : 123	Complete to set "Call Log Lock, Incoming". Complete to set "Electronic Station Lockout".
Lunch Mode	MODE PAUSE-CAFE	Complete to set "Lunch Mode".
Message Cancel	MESSAGE ANNULE	Cancel Absent Message.
MW at Ext 1234	MESS. PST 1234	Complete to set "Message Waiting".
MW Not Accepted	MESS ATT. REFUSE	Not complete to set "Message Waiting".
MW Cancel:E1234	MESS ANNUL:P1234	Cancel "Message Waiting" of desired extension.
MW Cancelled	MESS ATT. ANNULE	Cancel one's own "Message Waiting".
Night Mode	SERVICE DE NUIT	Night mode status. (Cancel Day mode.) — "Night / Day (Lunch / Break) Service"
No Held Call	AUCUN APPEL ATT.	There is no held call when retrieving call on hold or parked call.
No Incoming Call	AUCUN APPEL ENT.	There is no incoming call when trying to pick up the call.
Not Valid	NON VALIDE	Illegal operation.
OGM 1 Play:28	REP 1 LECT:28	When playing back the OGM.
OGM 1 Rec:12	REP 1 ENP:12	When recording back the OGM.
Out Until 12/12	Out Until 12/12	Absent Message 5.
Paging Deny Off	APPEN GEN. NON	Cancel "Paging — DENY".
Paging Deny On	APPEN GEN. OUI	Complete to set "Paging — DENY".
Parallel Off	PARALLELE : NON	Cancel "Paralleled Telephone Connection".
Parallel On	PARALLELE:OUI	Complete to set "Paralleled Telephone Connection".
Park at 0 N/A	ATT. A 0 N.VAL	Not complete to set "Call Park".
PT-PGM Mode	TP-MODE PROG	Entered the Station Programming mode.
RCL:Tony Viola	RAPL:Tony Viola	Called by transfer recall, with name. — "Call Transfer"
RCL:Ext 1234	RAPL:PST 1234	Called by transfer recall, without name. — "Call Transfer"
Restricted	RESTREINT	An outgoing call is restricted.
Ringer : ***	SONN. : ***	Volume Control — ringer on idle status.

English Display	French Display	Description
SP:*****	HP:*****	Volume Control — speaker on hands-free mode.
Transfer to CO	TRANSFERT A LR	The destination extension is set "Call Forwarding — to Outside Line".
Unlocked	DEVERROUILLE	Cancel "Call Log Lock, Incoming". Cancel "Electronic Station Lockout".
Will Return Soon	Will Return Soon	Absent Message 1.

*1 Provides you with a caller's information, such as his/her name and telephone number, on the outside line assigned to receive Caller ID service calls. This requires a subscription for caller identification services. For more details, please consult with your dealer.

Examples — in Station Programming mode

English Display	French Display	Description
Account	COMPTE	Account button is assigned.
C.W. Tone1	TON.APPEL1	Select Call Waiting tone.
Clear Ready?	ANNULER DONNEES?	Available to clear Station Programming data.
CO-01	LR-01	Single-CO (S-CO) button is assigned.
Conference	CONFERENCE	Conference (CONF) button is assigned.
140:CO Lock	140:LR VERR.	Complete to lock the outside calls of other extension. — "Remote Station Lock Control".
140:ICM Lock	140:INTCM VERR.	Complete to lock the intercom calls of other extension. — "Remote Station Lock Control".
140:Unlock	140:DEVERR	Cancel "Remote Station Lock Control"
Ext-123	PST-123	DSS button is assigned.
FWD/DND	RNV/NPD	FWD/DND button is assigned.
Hands-free:Off	MAINS LIB.:NON	Disable "Full One-Touch Dialing" mode.
Hands-free:On	MAINS LIB.:OUI	Enable "Full One-Touch Dialing" mode.
Handset	COMBINE	Select Handset mode.
Headset	CASQUE	Select Headset mode.
Jack04 <=> EXT104	10101 <=> PST104	Confirm jack number and extension number.
Loop-CO	BOUCLE DE LR	Loop-CO (L-CO) button is assigned.

English Display	French Display	Description
Message Waiting	MESS. EN ATTENTE	Message Waiting (MESSAGE) button is assigned.
NIGHT	NUIT	Night button is assigned.
Not Stored	NON MEMORISE	No programming is assigned.
Pref.In :CO-02	ENT.PREF:LR-02	Select "Prime Line (Outside Line) Preference — Incoming".
Pref.In :NO	ENT.PREF:NON	Select "No Line Preference — Incoming".
Pref.In :Ring	ENT.PREF:SONN	Select "Ring Line Preference — Incoming".
Pref.Out:CO-02	SOR.PREF:LR-02	Select "Prime Line (Outside Line) Preference — Outgoing".
Pref.Out:ICM	SOR.PREF:INTCM	Select "Prime Line (INTERCOM) Preference — Outgoing".
Pref.Out:Idle	SOR.PREF:LIB.	Select "Idle Line Preference — Outgoing".
Pref.Out:No	SOR.PREF:NON	Select "No Line Preference — Outgoing".
Save	SAUVEGARDE	SAVE button is assigned.
Tone Call	APPEL-TON.	Select Ring-Calling mode.
Tone Type-2	TON. TYPE-2	Select ringing tone for a CO button or intercom calls.
TRK GRP-3	GR LR-3	Group-CO (G-CO) button is assigned.
VTR-101	TMV-101	Voice Mail (VM) Transfer button is assigned.
Voice Call	APPEL VOCAL	Select Voice-Calling mode.
092-555-2111	092-555-2111	One-Touch Dialing button is assigned.

Conditions

- If the displayed characters exceed sixteen digits, "&" is shown at the right-hand edge.
- The duration time display is only shown when you make or receive an outside call. Count start time for outgoing calls can be programmed as desired.
- When you confirm key programming, be sure to press a button while on-hook. If the "Full One-Touch Dialing" feature is set, dialing mode will start when pressing PF (Programmable Feature), DSS (Direct Station Selection), SAVE or REDIAL button.

6.1.2 Feature Number List

Numbers listed below are the initial factory settings (default value). There are flexible feature numbers and fixed feature numbers. To change the flexible feature numbers, System Programming is required. For programming instructions, please consult with your dealer. Some Additional Required Digits are different depending on the mode of the Digital Super Hybrid System your telephone is connected to.

Flexible Feature Numbers

Feature	Default	Additional Digits
1st hundred block extension	1	0-9, 00-99
2st hundred block extension	2	0-9, 00-99
3st through 16th hundred block extension block	—	0-9, 00-99
Absent Message capability set/cancel	750	1-9 / 0
Account Code Entry	49	Account code + # (99)
Automatic Callback Busy (Camp-On) cancel	46	
Background Music (BGM) — External on/off	35	
Call Forwarding — set/cancel	710	2-6 / 0
Call Forwarding — Follow Me set/cancel	710	7/8
Call Hold	50	
Call Hold, Retrieve outside call	53	01-08 (for KX-TD816) 01-48 (for KX-TD1232)
Call Hold, Retrieve intercom call	51	extension no.
Call Log Incoming set/cancel	56	1/0
Call Log Lock Incoming lock	57	000-999 twice
Call Log Lock Incoming Unlock	57	000-999 (same lock code)
Call Park/Call Park Retrieve	52	0-9
Call Pickup, Directed	41	EXTN. (extension no.)
Call Pickup, Group	40	
Call Pickup, Outside Line	4*	
Call Pickup Deny set/cancel	720	1/0
Call Waiting set/cancel	731	1/0
CTI Code Entry	—	CTI code + # (99)
Data Line Security set/cancel	730	1/0
Do Not Disturb (DND) set/cancel	710	1/0

Flexible Feature Numbers

Feature	Default	Additional Digits
Doorphone Call calling / door open	31 / 55	1-2 (for KX-TD816); 1-4 (for KX-TD1232)
Electronic Station Lockout set	77	000-999 twice
Electronic Station Lockout cancel	77	000-999
Executive Busy Override Deny set/cancel	733	1 / 0
External Feature Access	6	
Hotel Application — Room Status	736	
Live Call Screening (LCS) Password set	799	000-999 twice
Live Call Screening (LCS) Password cancel	799	000-999
Log-In/Log-Out	45	1 / 0
Message Waiting set/cancel	70	1+extension no. / 0+extension no.
Message Waiting call back	70	2
Night Service (Day / Night / Lunch / Break)	78	0-3
Off-Hook Call Announcement (OHCA) set/ cancel	731	2 / 0
Operator Call	0	
Outgoing Message (OGM) recording/ playback* ¹	36	1+OGM No. (1-4) / 2+OGM No. (1-4)
Outward Dialing — Line Access, Automatic/ ARS	9	
Outward Dialing — Outside Line Group	8	1-8
Paging — All	32 / 33	*
Paging — Deny set/cancel	721	1 / 0
Paging — External all	32	0
Paging — External particular	32	1-2 (for KX-TD816); 1-4 (for KX-TD1232)
Paging — External Answer/TAFAS Answer	42	1-2 (for KX-TD816); 1-4 (for KX-TD1232)
Paging — Group all / particular	33	0 / 1-8
Paging — Group Answer	43	
Paralleled Telephone Connection set/cancel	39	1 / 0
Pickup Dialing (Hot Line) assign/set/cancel	74	2+phone no. + # / 1 / 0
Redial, Last Number (for SLT)	#	
Station Program clear	790	
Station Speed Dialing	3*	0-9

Flexible Feature Numbers

Feature	Default	Additional Digits
Station Speed Dialing programming	30	(0-9)+phone no. + #
System Speed Dialing (for SLT)	*	000-499
System Working Report print out / clear	794	1 / 0
Timed Reminder set	76	1+hhmm ^{*2} +(0 / 1)+(0 / 1)
Timed Reminder cancel/confirm	76	0 / 2
Timed Reminder, Remote set	7*	1+extension no. +hhmm ^{*2} +(0 / 1)+(0 / 1)
Timed Reminder, Remote cancel/confirm	7*	0+extension no. / 2+extension no.
Walking COS set	47	Walking COS password+your extension no.
Whisper OHCA set/cancel	731	3 / 0

*1 Available for the KX-TD1232 only

*2 hhmm hh: hour(01-12) mm: minute(00-59)

Fixed Feature Numbers

Feature	Default
<i>While a busy tone is heard:</i>	
Automatic Callback Busy (Camp-On)	6
Busy Station Signaling (BSS)	1
Executive Busy Override	2
Off-Hook Call Announcement (OHCA)	1
OHCA, Whisper	1
<i>While Do Not Disturb tone is heard:</i>	
Do Not Disturb (DND) Override	1
<i>During calling or talking:</i>	
Account Code Delimiter	#/99
Alternate Calling — Ring/Voice	*
Conference	3
Door open	5
Pulse to Tone Conversion	*#
<i>When the telephone is on-hook:</i>	
Background Music (BGM) on/off	1
Day/Night mode display	#
Date and Time display/Self-Extension Number and name display switching	*

Conditions

- Extension numbers can be three or four digits in length. Any number can be set as the leading first or second digit.
- Flexible feature numbers can only be dialed while a dial tone is heard.
- When "*" or "#" are included in a feature number, it will not be possible for users with dial pulse (DP) telephones to access the feature.

Programming Guide References

[003] Extension Number Set

[100] Flexible Numbering

User Manual References

3.2.4 [003] Extension Number Set

6.1.3 Tone List

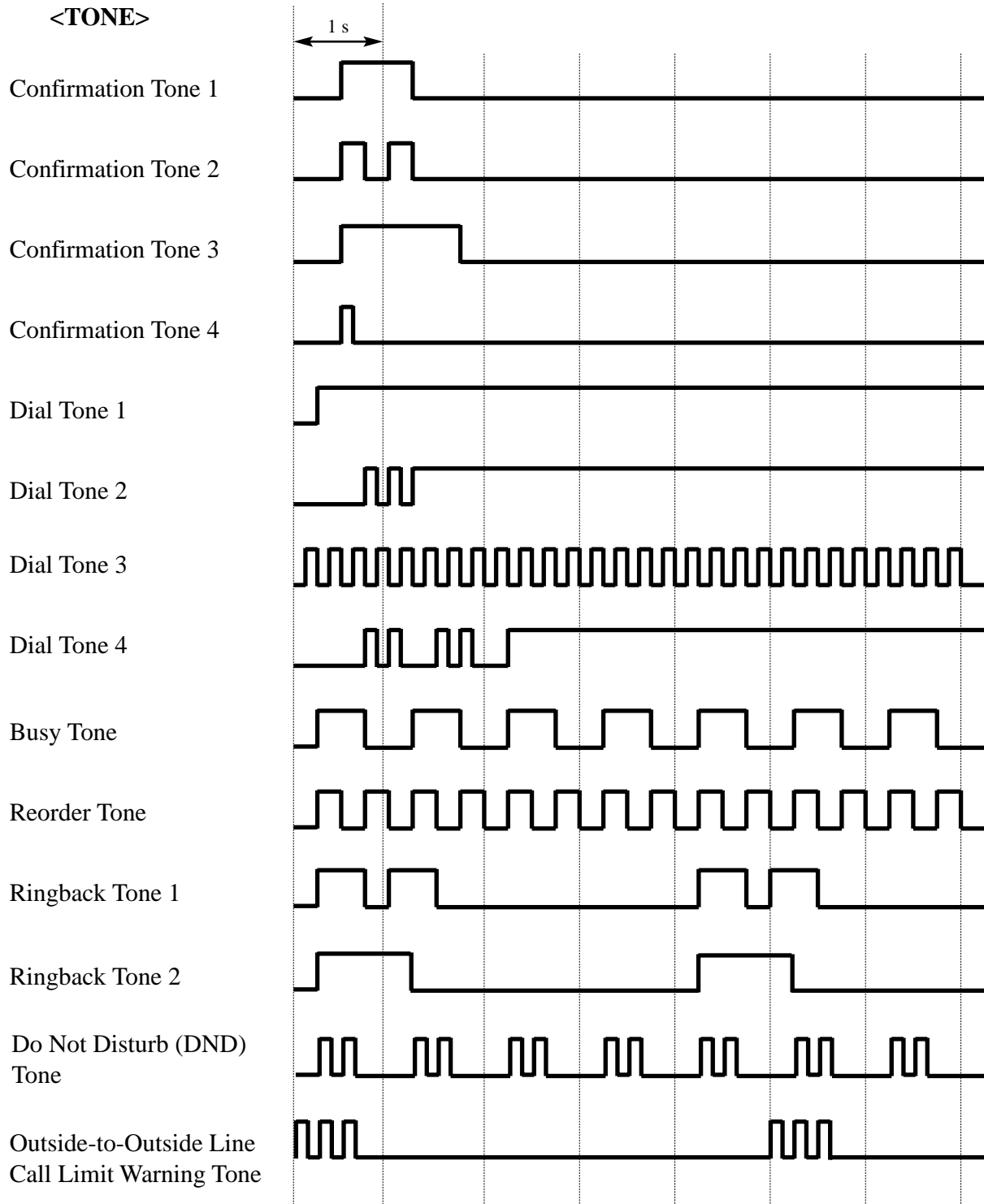

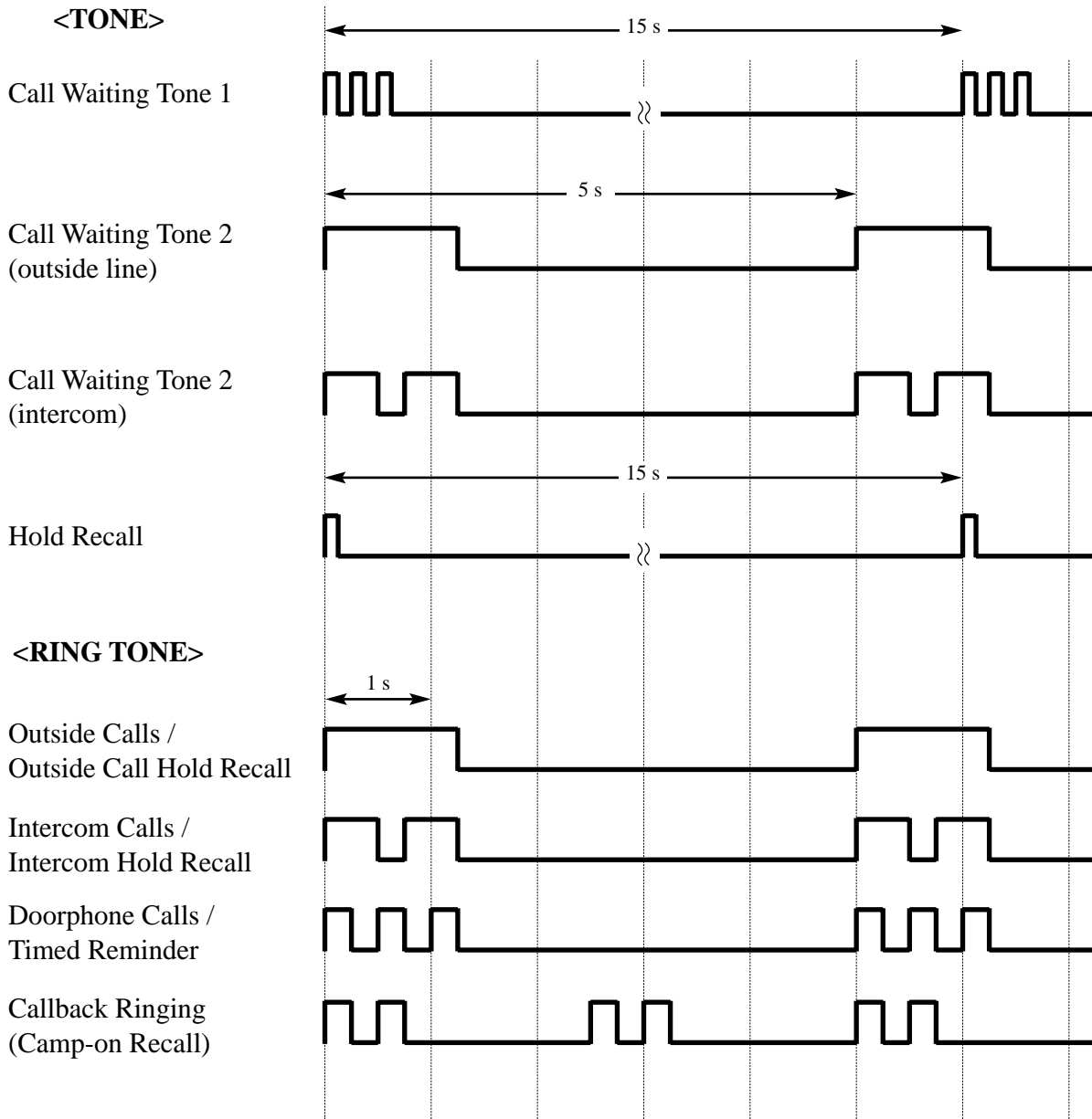

6.1.4 Troubleshooting

If a power failure should occur...

Your System enables conversations between specific outside lines and extensions (Power Failure Transfer), and supports system data backup.

Power Failure Transfer

Specific extensions are automatically connected straight to specific outside lines. This provides outside line conversations between the pre-assigned extensions and outside lines:

<KX-TD816>

- Outside line 01 is connected to extension jack number 01.
- Outside line 02 is connected to extension jack number 02.
- Outside line 05 is connected to extension jack number 09.
- Outside line 06 is connected to extension jack number 10.

<KX-TD1232>

- Outside line 01 is connected to extension jack number 01.
- Outside line 02 is connected to extension jack number 02.
- Outside line 03 is connected to extension jack number 09.
- Outside line 04 is connected to extension jack number 10.
- Outside line 09 is connected to extension jack number 17.
- Outside line 10 is connected to extension jack number 18.
- All other conversations are disconnected during a power failure.
- Digital proprietary telephones (DPTs) cannot be used during a power failure. SLTs can work in the event of a power failure.
- When power is restored after a power failure, your system automatically restarts operation, maintaining as much of the previous system data as possible.

Problem	Probable Cause	Possible Solution
Nothing is heard in the hands-free mode.	The "Headset" mode is selected.	When the headset is not used, set the mode to "Handset." Refer to "Handset/Headset Selection" in Station Programming (Section 2), or "Initial Setting" (Section 1).
The unit does not ring.	<ul style="list-style-type: none"> • The outside number is not programmed. • The Ringer Volume is set to "OFF". 	<ul style="list-style-type: none"> • For programming outside numbers, refer to the Installation Manual. • Increase the Ringer Volume. Refer to "Initial Setting" (Section 1).

Problem	Probable Cause	Possible Solution
The display flashes the following message: <div data-bbox="175 338 475 373" style="border: 1px solid black; padding: 2px;">Set Time & Date</div> <div data-bbox="175 426 475 462" style="border: 1px solid black; padding: 2px;">THU JAN01 12:00A</div>	The system internal clock does not work properly.	Consult with an authorized Panasonic Factory Service Center.

Section 7
Index

A

Absent Message Capability 100
Account Code Entry 103
Alternate Calling — Ring / Voice 107
ANSWER 351
ANSWER and RELEASE Buttons Operation
361
Answering, Direct Outside Line 109
AUTO ANSWER/MUTE 28
AUTO DIAL/STORE 28
Automatic Callback Busy 110

B

Background Music (BGM) 113
Background Music (BGM) — External 279
Bilingual Display Selection 53, 364
BSS / OHCA / Whisper OHCA 114, 150, 218
Busy Station Signaling (BSS) 114

C

Call Forwarding / Do Not Disturb 309
Call Forwarding — All Calls 118
Call Forwarding — Busy 119
Call Forwarding — Busy / No Answer 122
Call Forwarding — CANCEL 128
Call Forwarding — Follow Me 126
Call Forwarding — No Answer 120
Call Forwarding — SUMMARYCall Forwarding
— SUMMARY 116
Call Forwarding — to Outside Line 124
Call Hold 130
Call Hold Retrieve 134
Call Hold, Exclusive 132
Call Log Lock Control, Incoming 282
Call Log Lock, Incoming 317
Call Log, Incoming 311
Call Log, Outgoing 319
Call Monitoring in Station Hunting 320
Call Park 136
Call Pickup Deny 141
Call Pickup, Directed 138
Call Pickup, Group 139
Call Pickup, Outside Line 140
Call Splitting 142
Call Transfer 360
Call Transfer — to Extension 144
Call Transfer — to Outside Line 147
Call Waiting 149, 218
Call Waiting from Central Office 152
Call Waiting Tone Type Assignment 53
Call Waiting Tone Type Selection 151
Camp-On Transfer to Phantom Extension 154
Class of Service 91
CONF 28
Conference 156
Conference, Unattended 160

Configuration 16, 348
Connection 26
CTI (Computer Telephony Integration) Code
Entry 162

D

Data Line Security 151, 163
Date and Time Set 76
Direct Inward System Access (DISA) 165
Direct Station Dialing 357
DISA User Codes 91
Display Contrast Adjustment 34, 39
Display Examples 364
Display Features 322, 334
Display Features - Call Directory 324, 337
Display Features - System Feature Access Menu
325, 342
Do Not Disturb (DND) 169
Do Not Disturb (DND) Override 172
Doorphone Call 174
DSS 351

E

Electronic Station Lockout 177
Emergency Call 179
Entering Characters 74
Executive Busy Override Deny 181, 182, 184
Executive Busy Override — Extension 180
Executive Busy Override — Outside Line 182
Extension Name Set 88
Extension Number Assignment 354
Extension Number Set 85
External Feature Access 185

F

Feature Buttons 28, 351
Fixed Buttons 28
Fixed Feature Numbers 373
FLASH 28
Flash 187
Flexible Buttons 28
Full One-Touch Dialing 188, 225
Full One-Touch Dialing Assignment 53
Function buttons 28
FWD/DND 28

G

General Programming Instructions 70

H

Handset Microphone Mute 189
Handset/Headset Selection 53
Hands-free Answerback 190
Hands-free mode 195
Hands-free Operation 191

HOLD 28
Hotel Application — Room Status 283

I

Initial Display Selection 53
Initial Setting for KX-T7200 Series 39
Initial Setting for KX-T7400 Series 34
Initial Settings 52
INTERCOM 28
Intercom Alert Assignment 53
Intercom Calling 97, 193

J

Jog Dial 28, 29, 335

L

LCS Password Clear 201
LED Indication 43
Line Access 97
Line Access, Automatic 227
Line Access, Individual 227
Line Access, Outside Line Group 227
Live Call Screening (LCS) 195
Live Call Screening Mode Set 53
Live Call Screening Password Control 286
Location of Controls 17, 349
Lockout 202
Log-In / Log-Out 203

M

Making Calls 97
MESSAGE 28
Message Waiting 205
Microphone Mute 209
MODE 28
MONITOR 28

N

Night 31, 210

O

Off-Hook Call Announcement (OHCA) 215
Off-Hook Call Announcement (OHCA) —
Whisper 219
Off-Hook Monitor 223
One-Touch Access for System Features 359
One-Touch Dialing 225, 358
One-Touch Dialing Assignment 355
One-Touch Transfer 360
Operator Call 226
Operator/Manager Service Features 278
Outgoing Message (OGM) 287
Outward Dialing 97, 227
Overlay 71

P

Paging and Transfer 236
Paging — ANSWER 234
Paging — Deny 235
Paging — SUMMARY 230
Paralleled Telephone Connection 240
PAUSE 28
PF 351
Phantom Extension 242
Phantom Extension Ringing On/Off Set 56
Pickup Dialing (Hot Line) 246
Preferred Line Assignment 52
Privacy Release 248
Private mode 195
PROGRAM 28
Programming Methods 74
Programming Mode Display 46
Pulse to Tone Conversion 250

Q

Quick Dialing 251

R

Receiving Calls 99
REDIAL 28
Redial, Last Number 252
Redial, Saved Number 253
RELEASE 351
Remote Station Lock 177
Remote Station Lock Control 296
Ring/Voice Intercom Alerting Mode Override
190
Ringing Tone Selection for CO Buttons 57

S

Secret Dialing 254
SELECT 28
Self-Extension Number Confirmation 59
SHIFT 28
Soft buttons 28
Special Display Features 308
SP-PHONE 28
Station Message Detail Recording 263
Station Program Clear 255
Station Programming Data Default Set 60
Station Programming Instructions 46, 352
Station Speed Dialing 257
Station Speed Dialing Number/Name
Assignment 61
System Feature Access Menu 322, 334
System Speed Dialing 259
System Speed Dialing Name Set 82
System Speed Dialing Number Set 79
System Working Report 297

T

- Timed Reminder 261
- Timed Reminder, Remote (Wake-Up Call) 300
- Toll Restriction Override by Account Code Entry 265
- Toll Restriction Override for System Speed Dialing 266
- Toll Restriction Override — SUMMARY 264
- Tone List 375
- TRANSFER 29
- Troubleshooting 377
- Trunk Answer From Any Station (TAFAS) 267
- Two-Way Recording into Phantom mailbox 269
- Two-Way Recording into Voice Mail 268

U

- Uniform Call Distribution (UCD) 270
- User Programming Password 73

V

- Voice Mail Integration 271
- Voice Mail Transfer 274
- Voice Mail Transfer to Phantom Mailbox 274
- VOLUME 29
- Volume Control 35, 39
- VPS Integration 207

W

- Walking COS 276

Panasonic Canada Inc.

5770 Ambler Drive, Mississauga,
Ontario L4W 2T3
www.panasonic.ca

Copyright:

This manual is copyrighted by Kyushu Matsushita Electric Co., Ltd. (KME). Under the applicable copyright laws, this manual may not be reproduced in any form, in whole or part, without the prior written consent of KME and its licensee.

© 2001 Kyushu Matsushita Electric Co., Ltd. All Rights Reserved.

Printed in Canada

PSQX2591ZA KA0901YM0